



**SAILFISH**  
BOATS



*SD*  
**SAILFISH**  
 B O A T S







**8**  
DUAL CONSOLES



**14**  
CENTER CONSOLES



**26**  
WALK AROUNDS



**30**  
BAY BOATS

# CONTENTS

## DUAL CONSOLES

325 DC.....	8
275 DC.....	10
245DC.....	12

## CENTER CONSOLES

320CC.....	14
290 CC.....	16
270 CC.....	18
242 CC.....	20
241 CC.....	22
220 CC.....	24

## WALK AROUNDS

320 EXP.....	26
270 WAC.....	27
240 WAC.....	28
220WAC.....	29

## BAY BOATS

2100BB.....	30
1900BB.....	31

## FEATURES & OPTIONS

.....	34
-------	----



**34**  
FEATURES & OPTIONS

SEATING.....	41
--------------	----

COVERS.....	43
-------------	----

TOP OPTIONS.....	44
------------------	----

HULL COLORS.....	45
------------------	----



**41**  
SEATING



**43**  
COVERS



**44**  
TOP OPTIONS



**45**  
HULL COLORS



## FISHING FOCUSED

At its core, Sailfish is a fishing boat designed by anglers for anglers. It is built to withstand the rigors of inshore and offshore environments and is loaded with more standard fishing features than any other boat on the water. We offer a wide range of options that allow you to customize your Sailfish for whatever type of fishing you wish to pursue. From inshore to deep water, 19 to 32 feet, you will find a Sailfish that will accommodate any fishing adventure or family outing.



## FAMILY FRIENDLY

Every Sailfish has the built-in versatility to be a serious fishing boat one day and a family fun boat the next! With comfortable full bow seating, stow away tables, abundant storage space, a roomy head and a retractable ski tow bar, your Sailfish transforms into the perfect platform for an exciting day on the water. Sailfish also provides family safety with the highest cockpit depth in the industry, keeping water out and people in. They also feature the largest recessed cockpit drains in their class, allowing the maximum amount of water to exit the deck, this provides for an extra level of safety.



# ADVANCED DESIGN

## INTELLIGENT ERGONOMICS

Have you ever been on a boat and thought, "Why on Earth did they do that?" Unless you're on a Sailfish, the answer is often because "they" added a feature as an afterthought. We design each boat with intelligent ergonomics from the start. When you reach for something, it's there—from cupholders, rod holders and hand-holds to switches, latches and toe rails. Our comfortable seating is ideal for lounging in the shallows or racing the sunrise offshore. All hinges and deck lids are recessed into the mounting surface, providing added safety for your feet. Plumbing and electrical systems are carefully engineered and installed for years of trouble-free operation and easy access.

## INNOVATIVE DESIGN

For more than 30 years, our designers have set the standard for innovation in the industry. Features you'll find on many boats on the market today were first spotted on a Sailfish. We continue to push the industry forward—ensuring our boats have the best possible layout, design and functionality for anglers and families alike. Sailfish has the most standard premium features in our class and pioneering design elements you won't find on other boats.

## 10-YEAR HULL WARRANTY

Each Sailfish boat comes with a 10-year hull warranty. Our hulls and decks are reinforced with Kevlar® and Carbon Fiber for greater durability, and the entire stringer system is foam-filled for added safety. All Sailfish boats are built using the best materials and proven manufacturing techniques. From start to finish, there are no shortcuts taken anywhere in the production process. Our quality control team takes great pride in ensuring your Sailfish is examined for flaws and imperfections before it leaves the plant.

## LIFETIME NO-ROT GUARANTEE

Sailfish uses absolutely no wood anywhere on our boats – that means a lifetime free of rotting, guaranteed! Our boats are made from 100% composite materials with stainless steel hardware. You will find many beautiful "fiberglass" boats on the water today that actually incorporate plywood encapsulated in fiberglass, which leaves them vulnerable to rotting. You can trust that you and your family will never have to worry about the engine falling off your Sailfish due to a rotted transom!

## VARIABLE DEGREE STEPPED HULL

Our exclusive Variable Degree Stepped (VDS) Hull design provides the smoothest ride of any fishing boat on the market. Its unique design features three distinct running surfaces. The first has a deep deadrise that cuts through the water, and two others that provide lift and stability. In addition, Sailfish has the deepest gunwales in its class, designed to keep passengers safely inside and water out. The beautiful, wide bow flare also aids in keeping water from blowing back into the boat. Whether you're idling or cutting through the surf, our VDS hull is the optimal design for a comfortable, safe ride.

# EXCLUSIVE VARIABLE DEGREE STEPPED (VDS) HULL

### Three Hulls in One:

- The first hull cuts the water.
- The second hull and down strakes create lift.
- The third hull creates stability.

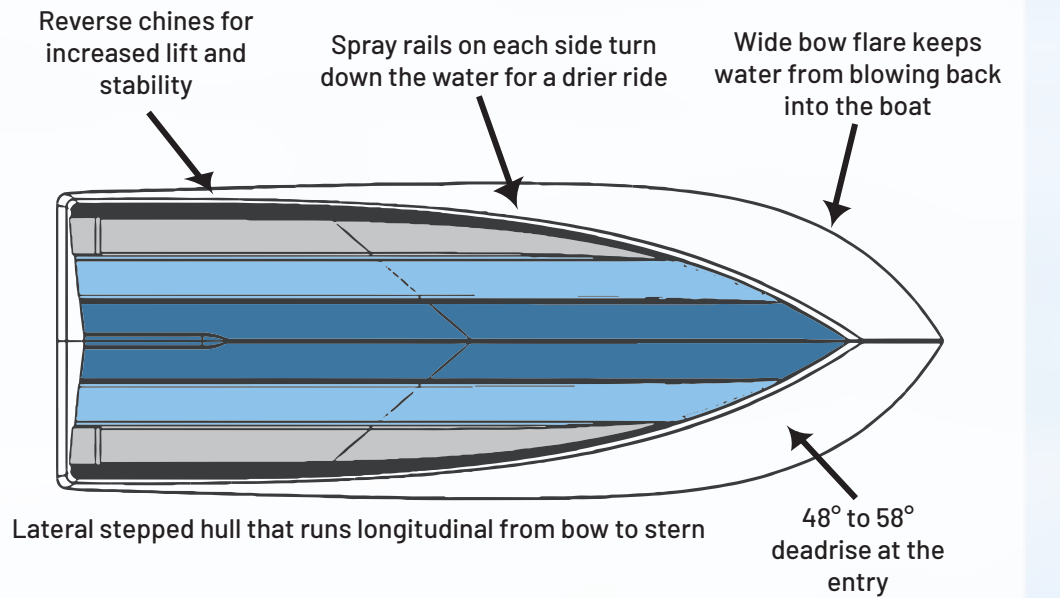
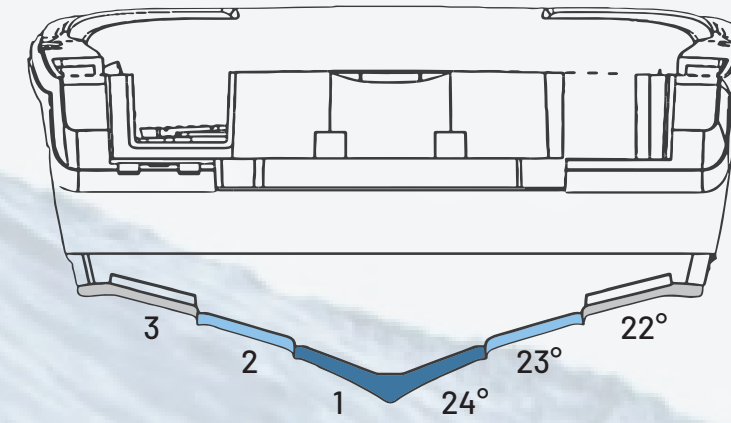

# SAILTECH CONSTRUCTION



# 325DC

DUAL CONSOLE

**31'6"**  
LOA HULL ONLY



**34'**  
LENGTH RIGGED



**10'**  
BEAM



**297 gal**  
FUEL CAPACITY



**21 gal**  
FRESH WATER



**11,066 lbs**  
WEIGHT



**31'**  
COCKPIT DEPTH REAR



**YC**  
(YACHT CERTIFIED)  
PERSON CAPACITY



**700 hp**  
MAX HP



**22"**  
DRAFT HULL



**22°-24°**  
DEAD RISE (MULTI-ANGLE)



**3**  
BATTERY CAPACITY



**15**  
ROD HOLDERS (STANDARD)



**8'9"**  
BRIDGE CLEARANCE (HARD TOP)



# 275DC

DUAL CONSOLE

**26'2"**  
LOA HULL ONLY

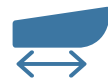

**28'2"**  
LENGTH RIGGED



**9'**  
BEAM



**188gal**  
FUEL CAPACITY



**14gal**  
FRESH WATER



**7,040lbs**  
WEIGHT



**30"**  
COCKPIT DEPTH REAR



**38"**  
BOW DEPTH



**400hp**  
MAX HP



**18"**  
DRAFT HULL



**22°-24°**  
DEAD RISE (MULTI-ANGLE)



**3**  
BATTERY CAPACITY



**8**  
ROD HOLDERS (STANDARD)



**YC**  
(YACHT CERTIFIED)  
PERSON CAPACITY

















**8'6"**  
BRIDGE CLEARANCE (HARD TOP)



# 245DC

DUAL CONSOLE















<b>24'</b> LOA HULL ONLY	<b>26'</b> LENGTH RIGGED	<b>8'6"</b> BEAM
		
<b>120 gal</b> FUEL CAPACITY	<b>14 gal</b> FRESH WATER	<b>5,350 lbs</b> WEIGHT
		
<b>27"</b> COCKPIT DEPTH REAR	<b>38"</b> BOW DEPTH	<b>300 hp</b> MAX HP
		
<b>18"</b> DRAFT HULL	<b>22°-24°</b> DEAD RISE (MULTI-ANGLE)	<b>2</b> BATTERY CAPACITY
		
<b>6</b> ROD HOLDERS (STANDARD)	<b>12</b> PERSON CAPACITY	<b>8'5"</b> BRIDGE CLEARANCE (HARD TOP)
		



 YAMAHA

# 320CC

CENTER CONSOLE

<b>31'6"</b> LOA HULL ONLY	<b>34'</b> LENGTH RIGGED	<b>10'</b> BEAM
		
<b>284gal</b> FUEL CAPACITY	<b>21gal</b> FRESH WATER	<b>10,500lbs</b> WEIGHT
		
<b>31"</b> COCKPIT DEPTH REAR	<b>40"</b> BOW DEPTH	<b>700hp</b> MAX HP
		
<b>22"</b> DRAFT HULL	<b>22°-24°</b> DEAD RISE (MULTI-ANGLE)	<b>3</b> BATTERY CAPACITY
		
<b>30</b> ROD HOLDERS (STANDARD)	<b>YC</b> (YACHT CERTIFIED) PERSON CAPACITY	<b>8'10"</b> BRIDGE CLEARANCE (HARD TOP)
		



# 290CC

CENTER CONSOLE

**28'6"**  
LOA HULL ONLY



**30'6"**  
LENGTH RIGGED



**9'**  
BEAM



**225gal**  
FUEL CAPACITY



**14gal**  
FRESH WATER



**8,000lbs**  
WEIGHT



**30"**  
COCKPIT DEPTH REAR



**40"**  
BOW DEPTH



**600hp**  
MAX HP



**21"**  
DRAFT HULL



**22°-24°**  
DEAD RISE (MULTI-ANGLE)



**3**  
BATTERY CAPACITY



**16**  
ROD HOLDERS (STANDARD)



**YC**  
(YACHT CERTIFIED)  
PERSON CAPACITY

















**8'10"**  
BRIDGE CLEARANCE (HARD TOP)



# 270CC

CENTER CONSOLE

<b>26'2"</b> LOA HULL ONLY	<b>28'2"</b> LENGTH RIGGED	<b>9'</b> BEAM
		
<b>188<sup>gal</sup></b> FUEL CAPACITY	<b>14<sup>gal</sup></b> FRESH WATER	<b>6,700<sup>lbs</sup></b> WEIGHT
		
<b>30"</b> COCKPIT DEPTH REAR	<b>40"</b> BOW DEPTH	<b>400<sup>hp</sup></b> MAX HP
		
<b>18"</b> DRAFT HULL	<b>22°-24°</b> DEAD RISE (MULTI-ANGLE)	<b>3</b> BATTERY CAPACITY
		
<b>12</b> ROD HOLDERS (STANDARD)	<b>YC</b> (YACHT CERTIFIED) PERSON CAPACITY	<b>8'6"</b> BRIDGE CLEARANCE (HARD TOP)
		



# 242CC















CENTER CONSOLE

<b>24'</b> LOA HULL ONLY	<b>26'</b> LENGTH RIGGED	<b>9'</b> BEAM
<b>146 gal</b> FUEL CAPACITY	<b>14 gal</b> FRESH WATER	<b>5,600 lbs</b> WEIGHT
<b>30"</b> COCKPIT DEPTH REAR	<b>40"</b> BOW DEPTH	<b>300 hp</b> MAX HP
<b>18"</b> DRAFT HULL	<b>22°-24°</b> DEAD RISE (MULTI-ANGLE)	<b>3</b> BATTERY CAPACITY
<b>12</b> ROD HOLDERS (STANDARD)	<b>10</b> PERSON CAPACITY	<b>8'6"</b> BRIDGE CLEARANCE (HARD TOP)



# 241CC











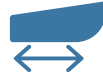



CENTER CONSOLE

<b>24'</b> LOA HULL ONLY	<b>26'</b> LENGTH RIGGED	<b>8'6"</b> BEAM
		
<b>108 gal</b> FUEL CAPACITY	<b>14 gal</b> FRESH WATER	<b>5,000 lbs</b> WEIGHT
		
<b>27"</b> COCKPIT DEPTH REAR	<b>32"</b> BOW DEPTH	<b>300 hp</b> MAX HP
		
<b>18"</b> DRAFT HULL	<b>22°-24°</b> DEAD RISE (MULTI-ANGLE)	<b>2</b> BATTERY CAPACITY
		
<b>12</b> ROD HOLDERS (STANDARD)	<b>10</b> PERSON CAPACITY	<b>8'6"</b> BRIDGE CLEARANCE (HARD TOP)
		



# 220CC

CENTER CONSOLE

<b>21'3"</b> LOA HULL ONLY	<b>23'3"</b> LENGTH RIGGED	<b>8'6"</b> BEAM
		
<b>93gal</b> FUEL CAPACITY	<b>6gal</b> FRESH WATER	<b>4,450lbs</b> WEIGHT
		
<b>26"</b> COCKPIT DEPTH REAR	<b>32"</b> BOW DEPTH	<b>200hp</b> MAX HP
		
<b>18"</b> DRAFT HULL	<b>22°-24°</b> DEAD RISE (MULTI-ANGLE)	<b>2</b> BATTERY CAPACITY
		
<b>10</b> ROD HOLDERS (STANDARD)	<b>8</b> PERSON CAPACITY	<b>8'4"</b> BRIDGE CLEARANCE (HARD TOP)
		



 YAMAHA



# 320EXP EXPRESS



<b>31'6"</b> LOA HULL ONLY 	<b>34'</b> LENGTH RIGGED 	<b>10'</b> BEAM 
<b>297<sup>gal</sup></b> FUEL CAPACITY 	<b>21<sup>gal</sup></b> FRESH WATER 	<b>11,850<sup>lbs</sup></b> WEIGHT 
<b>31'</b> COCKPIT DEPTH REAR 	<b>YC</b> (YACHT CERTIFIED) PERSON CAPACITY 	<b>700<sup>hp</sup></b> MAX HP 
<b>18"</b> DRAFT HULL 	<b>22°-24°</b> DEAD RISE (MULTI-ANGLE) 	<b>3</b> BATTERY CAPACITY 
<b>20</b> ROD HOLDERS (STANDARD) 	<b>9'7"</b> BRIDGE CLEARANCE (HARD TOP) 	

# 270 WAC WALKAROUND



<b>26'2"</b> LOA HULL ONLY 	<b>28'2"</b> LENGTH RIGGED 	<b>9'</b> BEAM 
<b>188<sup>gal</sup></b> FUEL CAPACITY 	<b>14<sup>gal</sup></b> FRESH WATER 	<b>7,400<sup>lbs</sup></b> WEIGHT 
<b>30'</b> COCKPIT DEPTH REAR 	<b>YC</b> (YACHT CERTIFIED) PERSON CAPACITY 	<b>400<sup>hp</sup></b> MAX HP 
<b>18"</b> DRAFT HULL 	<b>22°-24°</b> DEAD RISE (MULTI-ANGLE) 	<b>3</b> BATTERY CAPACITY 
<b>14</b> ROD HOLDERS (STANDARD) 	<b>8'11"</b> BRIDGE CLEARANCE (HARD TOP) 	



# 240 WAC WALKAROUND



<b>24'</b> LOA HULL ONLY 	<b>26'</b> LENGTH RIGGED 	<b>10'</b> BEAM 
<b>146 gal</b> FUEL CAPACITY 	<b>14 gal</b> FRESH WATER 	<b>5,600 lbs</b> WEIGHT 
<b>30'</b> COCKPIT DEPTH REAR 	<b>10</b> PERSON CAPACITY 	<b>300hp</b> MAX HP 
<b>18"</b> DRAFT HULL 	<b>22°-24°</b> DEAD RISE (MULTI-ANGLE) 	<b>3</b> BATTERY CAPACITY 
<b>10</b> ROD HOLDERS (STANDARD) 	<b>8'9"</b> BRIDGE CLEARANCE (HARD TOP) 	

# 220 WAC WALKAROUND



<b>21'3"</b> LOA HULL ONLY 	<b>23'6"</b> LENGTH RIGGED 	<b>8'6"</b> BEAM 
<b>93 gal</b> FUEL CAPACITY 	<b>6 gal</b> FRESH WATER 	<b>4,950 lbs</b> WEIGHT 
<b>26'</b> COCKPIT DEPTH REAR 	<b>8</b> PERSON CAPACITY 	<b>200hp</b> MAX HP 
<b>18"</b> DRAFT HULL 	<b>22°-24°</b> DEAD RISE (MULTI-ANGLE) 	<b>2</b> BATTERY CAPACITY 
<b>8</b> ROD HOLDERS (STANDARD) 	<b>8'4"</b> BRIDGE CLEARANCE (HARD TOP) 	



# 2100 BAY



**21'**  
LOA HULL ONLY

**23'**  
LENGTH RIGGED

**8'6"**  
BEAM

**63<sup>gal</sup>**  
FUEL CAPACITY

**5'5"**  
BRIDGE CLEARANCE (HARD TOP)

**3,625 lbs**  
WEIGHT

**14**  
ROD HOLDERS (STANDARD)

**7**  
PERSON CAPACITY

**200<sup>hp</sup>**  
MAX HP

**13"**  
DRAFT HULL

**18°**  
DEADRISE

**4**  
BATTERY CAPACITY

# 1900 BAY



**19'**  
LOA HULL ONLY

**21'**  
LENGTH RIGGED

**8'6"**  
BEAM

**53<sup>gal</sup>**  
FUEL CAPACITY

**5'5"**  
BRIDGE CLEARANCE (HARD TOP)

**2,750 lbs**  
WEIGHT

**12**  
ROD HOLDERS (STANDARD)

**5**  
PERSON CAPACITY

**200<sup>hp</sup>**  
MAX HP

**13"**  
DRAFT HULL

**18°**  
DEADRISE

**4**  
BATTERY CAPACITY





# SAILFISH LIFESTYLE

For over three decades, Sailfish has delivered on a promise of quality and innovation with its full line-up of reliable, versatile, stylish boats including Center Console, Dual Console Walk Around and Bay models. Our Sailfish family grows with every boat that is sold and we invite you to see for yourself. Meet the sunrise for an offshore angling adventure, make afternoon watersport waves with the family and gather friends for a sunset dinner cruise- all aboard your new Sailfish boat. We combine fishability for the serious angler and premium comfort and safety features for the family, today's Sailfish lets you get more from your boating investment.



# FEATURES OPTIONS

## 325DC

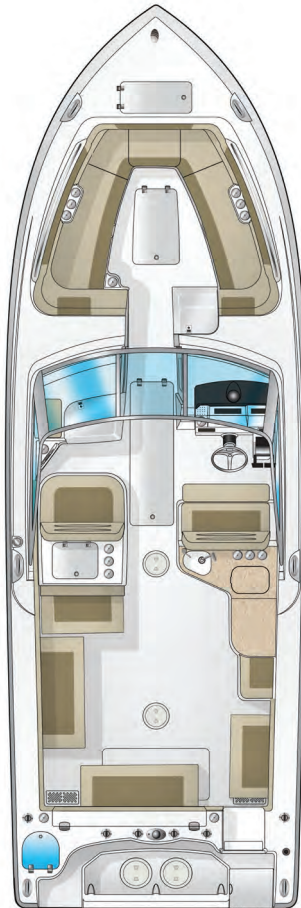

- SST Port Light (Head Compartment)
- Stainless Steering Wheel (Evo Pro w/ Leather Grips)
- Starboard Cockpit entry Step / Mid-Ship Towel Rack and Net Storage In the Starboard Storage Compartment Door
- Walk Thru Transom Door with Wave Guard & Step
- Yamaha 10 Micron Fuel Filter / Water Separator w/ SST Base

- Boat**
- Bow Block Off Door
  - Bow Bottom and Backrest Cushions
  - Powder Coated Built in Low Profile Bow Rails
- Cockpit Galley**
- 12 Volt DC Accessory Plug (4)
  - Corian Counter Top w/ Sink with Faucet, Fridge, Trash Can w/ Filler and Cutting Board
  - LED Strip Lighting
  - SST Soap Dispenser

- Electrical**
- 12 Volt DC Accessory Plug
  - Accessory Switch Panel w/Circuit Breakers
  - Captain Side Windshield Wiper
  - Compass
  - Electronically Actuated Bilge Access
  - Full Digital Instrumentation w/ Yamaha CommandLink or Mercury Vessel View
  - Fusion Stereo System w/ AMP, Sub-Woofers, Transom Remote Control, Bluetooth & USB Port
  - LED Interior Cockpit & Bilge Lighting
  - LED Navigational Pop Up Bow & Anchor Light
  - Trim Tabs / High Performance Dual Ram / Heavy Duty With Indicator Switch & Built In Auto Retract Feature
  - VSR Battery Charging System

- Fishing**
- 8 SST Deck Mounted Rod Holders
  - Aft In-Floor Fish Box
  - Baitwell w/ LED Lighting
  - Insulated Bow Fish Boxes with Overboard Drains

- Hardware**
- 8" Stainless Steel Pull Up Cleats (6)
  - Anchor Locker w/ Polished SST Thru The Hull Windlass
  - Fender Cleats Aft (2)
  - Finished Fiberglass Head
  - Flush Mount Hinges and Latches & Deck Plates
  - Galley / Head Compartment Lighting
  - Heavy Duty Stainless Steel Bow & Stern Eyes
  - Heavy Duty Stainless Steel Rub Rail
  - Mirror Galley / Head Compartment
  - Sailfish Engraved Transom Plates
  - Stainless Steel & Bronze Thru Hull Fittings
  - Stainless Steel Marine Grade Hardware
  - Stainless Steel Propellers
  - Stainless Steel Retractable Ski Tow Bar

### STANDARD FEATURES

- Boat**
- Boarding Ladder (4 step with grab handle)
  - Built In Rigging Tubes (From Bilge to Helm with pull tapes)
  - Carbon Fiber & Kevlar® Reinforced Deck & Hull
  - Closed Cell Foam Flotation
  - Cockpit Bolster Pads
  - Corian Counter Tops
  - Exclusive Dot Matrix Non-Skid
  - Exclusive VDS Hull Design (Variable Deadrise Stepped Hull)
  - Mercury Verado Fuel Filter / Water Separator
  - Passenger Pod w/ Top Mounted Built-In Storage Box
  - Powder Coated hard Top w/4 Rod Holders, Docking Lights, Spreader Lights, Overhead Lighting, PFD Storage & 2 Speakers
  - Powder Coated Walk Thru Windshield w/ Tempered Glass
  - Power Assist Hydraulic Steering w/ Tilt Wheel & Recessed SST Cup Holders (20)
  - SailTech Composite Full Length Transom
  - SailTech Foam Filled Fiberglass Stringer System

- Head**
- Sea Grass Removable Flooring In The Head
  - SST Soap Dispenser In The Galley / Head Compartment

- Helm**
- Large Dash Area For Flush Mounting Electronics
- Plumbing**
- 21 gal. Freshwater Tank
  - 4 - 2" Drains w/Collector Boxes for Self Bailing Cockpit
  - Automatic Bilge Pumps (Aft 2 - 2000 GPH & Forward 1 - 750 GPH)
  - SailTech Composite Full Length Transom
  - Freshwater Stations (3) (Galley / Head Cockpit Galley & Transom)
  - High Speed Livewell Pickup

- Pull Out Shower in Galley / Head
- Pull Out Transom Shower
- Raw Water Wash Down
- Sink with Faucet In The Galley / Head & Cockpit Galley

- Seating**
- Aft Fold Down Seat 48"
  - Deluxe Double Wide Captain's Chair with Flip Up Bolster & Arm Rest
  - Fold Out Port Mid-Ship Passenger Seat 27"
  - Passenger Seat w/ Storage, Cup Holders & Cooler
  - Port Aft Fold Down Seat 52"

- Storage**
- Battery Storage (Bilge Compartment)
  - Built-In Bow Cooler, Drains Overboard
  - In Floor Ski Locker (Mid-Ship)
  - In Floor Storage Box in the Bow
  - Recessed Rod Storage Starboard Side Aft
  - SST Facing Storage Center w/ Pull Out Drawers
  - Starboard Closet with Organizer Shelving
  - Starboard Helm Storage with Nets

### OPTIONS

- Boat Options**
- Bow Shower
  - Cockpit & Bow Covers
  - Grand Slam Outriggers
  - Hard Top Enclosure (3 Piece)
  - In-Floor Rod Storage
  - Mid-Ship Fender Cleats (2)
  - Misting System For Hard Top
  - Remote Spot Light on Hard Top
  - Removable Table Bow
  - Removable Table Stern
  - Sureshade MTF™
  - Sureshade MTF™
  - Two Tone Hard Top
  - Underwater LED Lights (3)

- Electronics & Sound System Options**
- Built-In 3 Bank Battery Charger w/ LED Readout
  - Garmin GPSMap 1042xsv w/o Transducer
  - Garmin GPSMap 7612xsv w/o Transducer
  - Garmin Radar & Power Cable 30' (Installed)
  - Garmin Thru Hull Transducer Airmar B60 (50/200Khz)
  - Garmin Thru Hull Transducer Airmar B75m (80/133Khz)
  - Garmin VHF Radio & Antenna
  - LED Lighted Speakers
  - Solar Battery Charger

- Seating Options**
- 36" Wide Starboard Aft Folding Seat
- Optional Packages**
- Galley Package
  - Shore Power, Electric Grill w/ Inverter / Battery Charger, Microwave & Built-In 3 Bank Battery Charger w/ LED Readout
  - Galley Pack Grill Delete

- Engine Options**
- Yamaha
  - Twin F300UCA
  - Mercury
  - Twin 300XXL Verado
  - Twin 350XXL Verado
  - White Painted Motors

- Helm**
- Large Dash Area For Flush Mounting Electronics
- Plumbing**
- 21 gal. Freshwater Tank
  - 4 - 2" Drains w/Collector Boxes for Self Bailing Cockpit
  - Automatic Bilge Pumps (Aft 2 - 2000 GPH & Forward 1 - 750 GPH)
  - SailTech Composite Full Length Transom
  - Freshwater Stations (3) (Galley / Head Cockpit Galley & Transom)
  - High Speed Livewell Pickup

## 275DC



- Walk Thru Transom Door with Wave Guard Step
- Yamaha 10 Micron Fuel Filter / Water Separator w/ SS Base

- Boat**
- Bow Block Off Door
  - Bow Bottom and Backrest Cushions
  - Chaise Lounge Style Seating
- Cockpit Galley**
- 12 Volt DC Accessory Plug
  - Corian Counter Tops and Sink Filler with Cutting Board
  - LED Strip Lighting
  - Pullout Drawers (2)
  - Tilt Out Trash Can

- Hardware**
- Fender Cleats Aft (2)
  - Flush Mount Hinges and Latches & Deck Plates
  - Heavy Duty Stainless Steel Bow & Stern Eyes
  - Heavy Duty Stainless Steel Rub Rail
  - Marine Grade Stainless Steel Hardware
  - Sailfish Engraved Transom Plate
  - Stainless Steel & Bronze Thru Hull Fittings
  - Stainless Steel Powder Coated Split Low Profile Bow Rails
  - Stainless Steel Propeller(s)
  - Stainless Steel Rod Holders (4)

- Head**
- Finished Fiberglass Head
  - Head Compartment Lighting
  - Lockable Head Door
  - Mirror
  - Sea Grass Removable Flooring
  - Sink w/ Faucet
  - SST Port Light
  - Towel Rack, TP Holder and Storage

- Helm**
- Large Dash Area (Capable of flush mounting 12" Screen)

- Electrical**
- 12 Volt DC Accessory Plug
  - Accessory Switch Panel w/Circuit Breakers
  - Compass
  - Full Digital Instrumentation
  - Heavy Duty High Performance Trim Tabs with Indicators & Auto Retract Feature
  - LED Interior Cockpit & Bilge Lighting
  - LED Navigational Bow & Anchor Light
  - VSR Battery Charging System

- Fishing**
- Baitwell w/ LED Lighting (30 gal. Transom)
  - Insulated Bow Fish Boxes with Overboard Drains (Twin 240 qt.)

- Plumbing**
- 14 gal. Freshwater Tank
  - Automatic Bilge Pump (2000 GPH Aft and 750 GPH Forward)
  - Freshwater Showers (2) - Transom And Hull
  - Head
  - High Speed Livewell Pickup
  - Pull Out Shower In Head
  - Pull Out Transom Shower
  - Raw Water Wash Down
  - Self Bailing Cockpit
  - Sink with Faucet (Galley)

- Seating**
- Aft Folding Seat 58" Flip up
  - Deluxe Captains Chair with Flip Up Bolster
  - Flip Flop Lounge Seat w/ Storage & Insulated Cooler
- Storage**
- Anchor Locker (Finished Fiberglass w/ Anchor Management System)
  - Battery Storage (Bilge Compartment)
  - Fiberglass Console Storage
  - In Floor Ski Locker (Mid-Ship)
  - In Floor Storage (Bow)
  - Recessed Rod Storage - Port & Starboard
  - Storage Center w/ Pull Out Drawers (Cockpit Galley)

### OPTIONS

- Boat Options**
- 12 Volt Refrigerator
  - 2 Additional Rod Holders (In Splashwell)
  - Additional Table Base
  - Cockpit & Bow Covers
  - CommandLink Plus (C Series Motors Only)
  - Electric Grill
  - Fiberglass Hard Top
  - Flip Up Bow Light (N/A w/ Anchor Roller or Windlass)
  - Flush Mount Cleats
  - Hard Top Enclosure (3 Piece)
  - In-Floor Rod Storage (3)
  - Mid-Ship Fender Cleats (2)
  - Polished Anchor Roller & SST Scuff Plate
  - Power Assist Steering (Standard w/ Verado's)
  - Propane Grill
  - Remote Spot Light for Hard Top
  - Removable Bow Table
  - Ski Tow Bar (Retractable)
  - SureShade MTF™
  - Stainless Steel & Bronze Thru Hull Transducer w/o CHIRP
  - Two Tone Hard Top
  - Underwater LED Lights (3)
  - VesselView 7"
  - Windlass w/ Polished Roller, SST Scuff Plate, Anchor, Rode & Chain
  - Windshield Wiper (Captain's Side)

- Electrical Options**
- Built-In 3 Bank Battery Charger w/ LED Readout
  - Fusion Stereo w/ 4 Speakers & USB Port
  - Fusion Transom Remote Control
  - Garmin B60 Airmar Thru Hull Transducer w/o CHIRP
  - Garmin B75M Airmar Thru Hull Transducer w/ CHIRP
  - Garmin GPSMap 1042xsv w/o Transducer
  - Garmin GPSMap 7612xsv w/o Transducer
  - Garmin VHF Radio & Antenna
  - LED Lighted Speakers Upgrade
  - Solar Battery Charger, Hard Top Only
  - Upgrade Sound System (Fusion Transom Remote, Amp, 10" Sub and LED Lighted Speakers)

- Plumbing Options**
- Electric Marine Head w/ Overboard Discharge
  - Misting System (For Hard Top only)
  - Pump Out Porta Potti

- Seating Options**
- Bow Filler Cushion
  - Capt. Chair Upgrade (Adjustable Height Pedestal and Flip Up Arm Rest)
  - Port Side Aft Fold Out Seat (48")

- Optional Packages**
- Entertainment Package
  - Ski Tow Bar, Removable Bow Table, Stereo w/USB Port & Underwater LED Lights (3) Galley Pack
  - Galley Package
  - Electric Grill, Shore Power & Built-In Battery Charger for Grill
  - Galley Pack Grill Delete

- Engine Options**
- Yamaha
  - Twin F150XB
  - Twin F200XB
  - Twin F200XCA
  - F300UCA
  - Mercury
  - Twin T50XL
  - Twin 200XL Verado
  - 350XXL Verado
  - White Painted Motor (n/a on T150's & T200's)

## 245DC

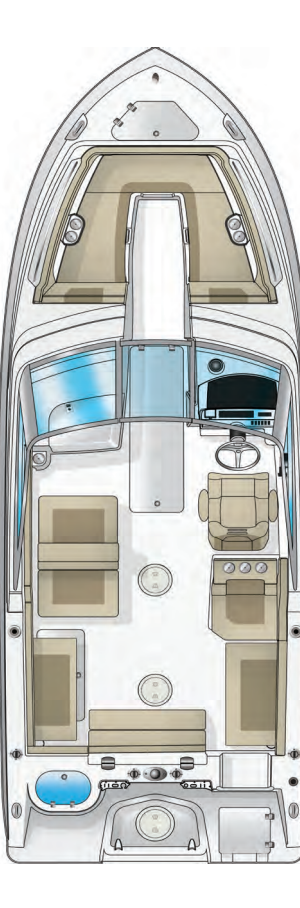

- Yamaha 10 Micron Fuel Filter / Water Separator w/ SS Base

- Boat**
- (2) 12 Volt Plugs
  - Bow Block Off Door
  - Bow Bottom and Backrest Cushions
  - Chaise Lounge Style Seating

- Electrical**
- 12 Volt DC Accessory Plug
  - Accessory Switch Panel w/Circuit Breakers
  - Compass
  - Electric Horn
  - Full Digital Instrumentation
  - LED Interior Cockpit & Bilge Lighting
  - LED Navigational Bow & Anchor Light

- Hardware**
- Fender Cleats Aft (2)
  - Flush Mount Cleats (6)
  - Flush Mount Hinges and Latches & Deck Plates
  - Heavy Duty Stainless Steel Bow & Stern Eyes
  - Heavy Duty Stainless Steel Rub Rail
  - Marine Grade Stainless Steel Hardware
  - Sailfish Engraved Transom Plate
  - Stainless Steel & Bronze Thru Hull Fittings
  - Stainless Steel Powder Coated Split Low Profile Bow Rails
  - Stainless Steel Propeller(s)
  - Stainless Steel Rod Holders (4)

- Head**
- Finished Fiberglass Head
  - Head Compartment Lighting
  - Lockable Head Door
  - Mirror
  - Sea Grass Removable Flooring
  - Sink w/ Faucet
  - SST Port Light
  - Towel Rack, TP Holder and Storage

- Helm**
- Large Dash Area (Capable of flush mounting 12" Electronics)

- Fishing**
- Baitwell w/ LED Lighting (25 gal. Transom)
  - In-Floor Fish Box - Port Side AFT
  - Insulated Bow Fish Boxes with Overboard Drains

- Plumbing**
- 14 gal. Freshwater Tank
  - Automatic Bilge Pump (2000 GPH Aft and 750 GPH Forward)
  - Freshwater Shower - Head
  - Freshwater Shower - Transom
  - High Speed Livewell Pickup
  - Pull Out Transom Shower
  - Raw Water Wash Down
  - Self Bailing Cockpit
  - Sink with Faucet (Galley)

### STANDARD FEATURES

- Boat**
- Bimini Top
  - Boarding Ladder (4 step with grab handle)
  - Built-In Rigging Tubes (From Bilge to Helm w/ pull tapes)
  - Carbon Fiber & Kevlar® Reinforced Deck & Hull
  - Closed Cell Foam Flotation
  - Cockpit Bolster Pads
  - Corian Counter Tops (Head)
  - Exclusive Dot Matrix Non-Skid
  - Exclusive VDS Hull Design (Variable Deadrise Stepped Hull)
  - Hydraulic Steering w/ Tilt Wheel
  - In-Floor Fish Box (w/ Advanced Vacuum Pump, Non-Macerated)
  - Mercury Verado Fuel Filter / Water Separator
  - Oversized Bilge Access
  - Powder Coated Walk Thru Windshield w/ Tempered Glass
  - Recessed SST Cup Holders (15)
  - SailTech Composite Full Length Transom
  - SailTech Foam Filled Fiberglass Stringer System
  - Stainless Steering Wheel (Evo Pro w/ Leather Grips)
  - Transom Mounted Tool & Washdown Hose Holder
  - Walk Thru Transom Door with Wave Guard Step

### OPTIONS

- 12 Volt Refrigerator
- 2 Additional Rod Holders (In Splashwell)

# FEATURES OPTIONS

## 320CC

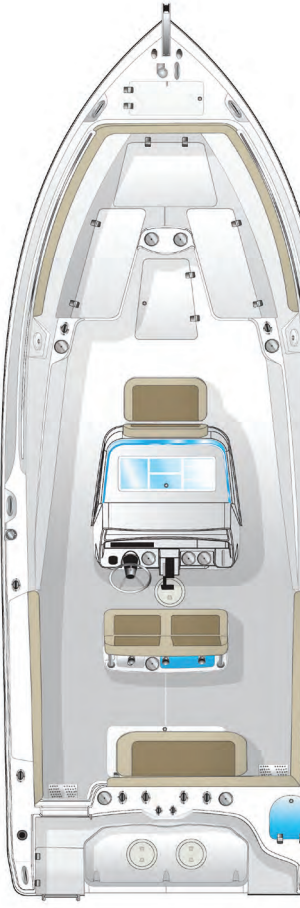

- System
- Stainless Steering Wheel w/ Power Knob
- T-Top w/ LED Spreader Lights / LED Overhead Lights & Rod Holders
- Two door access in console for wiring access
- Walk Thru Transom Door with Wave Guard Step
- Yamaha 10 Micron Fuel Filter / Water Separator w/ SS Base

- Boat**
- Insulated Bow Fish Boxes with Overboard Drains (Twin 260 qt.)

- Electrical**
- 12 Volt DC Accessory Plug
  - Accessory Switch Panel w/Circuit Breakers
  - Compass
  - Full Digital Instrumentation
  - Heavy Duty High Performance Trim Tabs with Indicators & Auto Retract Feature
  - LED Interior Cockpit & Bilge Lighting
  - LED Navigational Bow & Anchor Light
  - VSR Battery Charging System

- Fishing**
- Baitwell w/ LED Lighting (30 gal. Transom)
  - Baitwell w/ LED Lighting (35 gal. Leaning Post)
  - Built-In Tackle Storage (Aft Port & Starboard)

- Hardware**
- Fender Cleats Aft (2)
  - Flush Mount Cleats
  - Flush Mount Hinges and Latches & Deck Plates
  - Heavy Duty Stainless Steel Bow & Stern Eyes
  - Heavy Duty Stainless Steel Rub Rail
  - Marine Grade Stainless Steel Hardware
  - Sailfish Engraved Transom Plate
  - Stainless Steel & Bronze Thru Hull Fittings
  - Stainless Steel Bow Anchor Roller
  - Stainless Steel Propeller(s)
  - Stainless Steel Rod Holders (12)
  - Stainless Steel Split Low Profile Bow Rails

- Head**
- Fresh Water Sink
  - Head Compartment Lighting
  - Lockable Head Door
  - Mirror
  - SST Port Light

- Helm**
- Large Dash Area (Capable of flush mounting 15" Screen)

- Plumbing**
- Automatic Bilge Pump (2 - 2000 GPH Aft - 750 GPH Forward)
  - Freshwater Showers (3) - (Transom, Leaning Post and Head)
  - High Speed Livewell Pickup
  - Raw Water Wash Down
  - Self Bailing Cockpit (w/ (4) 2" Drains with Collector Box)
  - Sink with Faucet (In Head)

- Seating Options**
- 35 Gal. Livewell Leaning Post w/ Flip Up Bolsters, Backrest w/ Rod Holders, Footrest and 2 Drawer Storage

- Storage**
- Anchor Locker (Finished Fiberglass w/ Anchor Management System)
  - Battery Storage (In Head)
  - Deluxe Walk In Console (Lockable) w/ SST Port Light
  - Downrigger Ball Holders (4)
  - Footrest Console Storage
  - In-Floor Storage - Bow (w/ Bucket Holder)
  - Insulated - Fish Box in Floor Aft (320 qt.)
  - Net Storage in Head
  - Recessed Rod Storage - Port & Starboard
  - Tackle Storage Port & Starboard
  - Top Mounted Recessed Console Tackle Organizer (CTO)
  - Vanity Storage in Head

### OPTIONS

- Boat Options**
- Bow Rod Holders (2)
  - Bow Shade, Hard Top Only
  - Captain's Anti-Fatigue Pad
  - CommandLink Plus (C Series Motors Only)
  - Console & Leaning Post Covers
  - Deluxe Hard Top Upgrade (Powder Coated - White or Black)
  - DLX Hard Top Acrylic Enclosure (3 Piece)
  - Grand Slam Outriggers w/ 15' Poles
  - Ladder Back Hard Top Upgrade (Powder Coated - White or Black)
  - Mid-Ship Fender Cleats (2)
  - Powder Coat for Standard T-Top, Bow Rails & Leaning Post (White or Black)
  - Power Assist Steering (Y) (Std on T300HP)
  - Removable Bow Table
  - T-Top/DLX Hard Top Enclosure (3 Piece)
  - Thru Hull Windlass System
  - Two Tone Hard Top
  - Underwater LED Lights (3)
  - VesselView 7"
  - Windlass w/ Polished Roller, SST Scuff Plate, SST Anchor, Rode & Chain

- Electrical Options**
- Built-In 3 Bank Battery Charger w/ LED Readout
  - Fusion Stereo w/ 4 Speakers & USB Port
  - Fusion Transom Remote Control
  - Garmin B60 Airmar Thru Hull Transducer w/o CHIRP
  - Garmin B75M Airmar Thru Hull Transducer w/ CHIRP
  - Garmin GPSMap 1042xsv w/o Transducer
  - Garmin GPSMap 7612xsv w/o Transducer
  - Garmin Radar Cable & Power Cable 30'
  - Garmin VHF Radio & Antenna
  - LED Lighted Speakers Upgrade
  - Solar Battery Charger, Hard Top Only
  - Upgrade Sound System (Fusion Transom Remote, Amp, 10" Sub and LED Lighted Speakers)

- Plumbing Options**
- Electric Marine Head w/ Overboard Discharge
  - Misting System (For Hard Top only)
  - Porta Potti

- Seating Options**
- 58" Aft Folding Seat
  - Bow Cushion Bottoms
  - Bow Filler Cushion
  - Forward Facing Bow Backrests
  - LP6 (Capt. Chairs LP w/35 GAL LW, Footrest & 2 Drawer Storage)
  - LP7 (Capt. Chairs LP w/Footrest & Built-in Twin Tackle Stations)
  - LP8 (Capt. Chairs Entertainment LP w/Corian Counter Top & SS Drawers & Fridge)
  - LP11 Capt. Chairs LP w/Footrest & Built-in Tackle Station
  - Rear Cooler Seat - 125 Qt. Yeti

- Optional Packages**
- Cruise Package
  - Bow Cushions Bottoms, Stereo w/ Remote Control & USB Port & Removable Bow Table

- Engine Options**
- Yamaha
  - Twin F200UCA
  - Twin F300UCA
  - Mercury
  - Twin 250XXL Verado
  - Twin 300XXL Verado
  - Twin 350XXL Verado
  - White Painted Motors (N/A on 250XXL)



# FEATURES OPTIONS

## 220CC

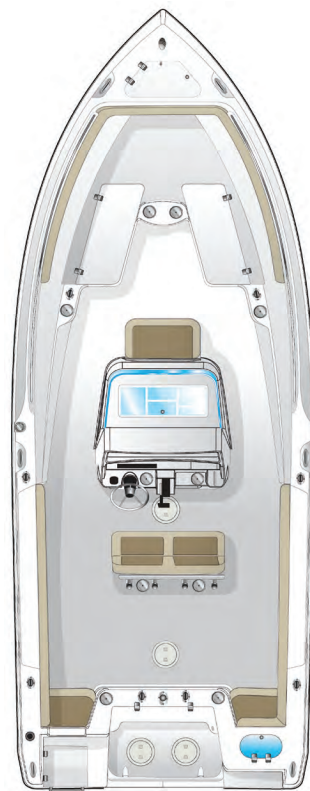

- Full Digital Instrumentation
- LED Interior Cockpit & Bilge Lighting
- LED Navigational Bow & Anchor Light
- Fishing
  - Baitwell w/ LED Lighting (25 gal. Transom)
  - Built-In Tackle Storage (Aft Under Transom Door)
- Hardware
  - Fender Cleats Aft (2)
  - Flush Mount Hinges and Latches & Deck Plates
  - Heavy Duty Stainless Steel Bow & Stern Eyes
  - Heavy Duty Stainless Steel Rub Rail
  - Marine Grade Stainless Steel Hardware
  - Sailfish Engraved Transom Plate
  - Stainless Steel & Bronze Thru Hull Fittings
  - Stainless Steel Propeller(s)
  - Stainless Steel Rod Holders (6)
  - Stainless Steel Split Low Profile Bow Rails
  - Wind Screen with Stainless Steel Grab Rail

- Head
  - Head Compartment Lighting
  - Lockable Head Door
  - Mirror
- Helm
  - Large Dash Area (Capable of flush mounting 8" Screen)
- Plumbing
  - Automatic Bilge Pump (2000 GPH)
  - Freshwater Shower (Transom)
  - High Speed Livewell Pickup
  - Raw Water Washdown
  - Self Bailing Cockpit
- Seating
  - Captain's Chairs w/ Removable Cushions (2)
  - Forward Helm Seating
- Storage
  - Battery Storage (Bilge Compartment)
  - Deluxe Walk In Console (Lockable) w/ Stainless Steel Port Light
  - Footrest Console Storage
  - Recessed Rod Storage - Port & Starboard

### OPTIONS

- Boat Options
  - Captain's Anti-Fatigue Pad
  - CommandLink Plus (C Series Motors Only)
  - Console & Leaning Post Covers
  - Console Top Tackle Organizer (CTO)
  - Fiberglass Hard Top
  - Netting Package
  - Powder Coated Bow Rails, LP & Top Frame (White or Black)
  - Removable Bow Table
  - T-Top Enclosure (3 Piece)
  - T-Top w/PPD Storage & LED Lights
  - Two Tone Hard Top
  - Underwater LED Lights (2)
  - VesselView 4"
- Electrical Options
  - Built-In 2 Bank Battery Charger
  - Fusion Stereo w/ 4 Speakers & USB Port
  - Fusion Transom Remote Control
  - Garmin B60 Airmar Thru Hull Transducer w/o CHIRP
  - Garmin B75M Airmar Thru Hull Transducer w/ CHIRP
  - Garmin GPSMap 741xs w/o Transducer
  - Garmin GPSMap 840xs w/o Transducer
  - LED Lighted Speakers
  - Standard Horizon VHF Radio and Antenna
  - Trim Tabs w/ Indicator Switch & Built In Retractor

- Hardware Options
  - Mid-Ship Fender Cleats (2)
  - Ski Tow Bar (Retractable)
- Plumbing Options
  - Porta Potti
- Seating Options
  - Bow Cushion Bolsters
  - Bow Cushion Bottoms

- Bow Filler Cushion
- Forward Facing Bow Backrests
- LP2 (Leaning Post) w/ Rod Holders & Removable Backrest)
- Rear Jump Seats
- Optional Packages
  - **Comfort Package**
  - Rear Jump Seats, Bow Cushion Bottoms & Bow Bolsters
  - **Entertainment Package**
  - Ski Tow Bar, Removable Bow Table & Stereo w/ USB Port & Underwater LED Lights (2)
  - **Offshore Tournament Pack**
  - T-Top w/ Weblon, Flush Mount Cleats, Flush Mounted Bow Light & Transom Rod Holders (3)
  - **Offshore Tournament Pack II**
  - Fiberglass Hard Top, Flush Mount Cleats, Flush Mounted Bow Light & Transom Rod Holders (3)

- Engine Options
  - Yamaha
  - F150XB
  - F200XB
  - F200XCA
  - Mercury
  - 150XL
  - 200XL Verado

## 320EXP

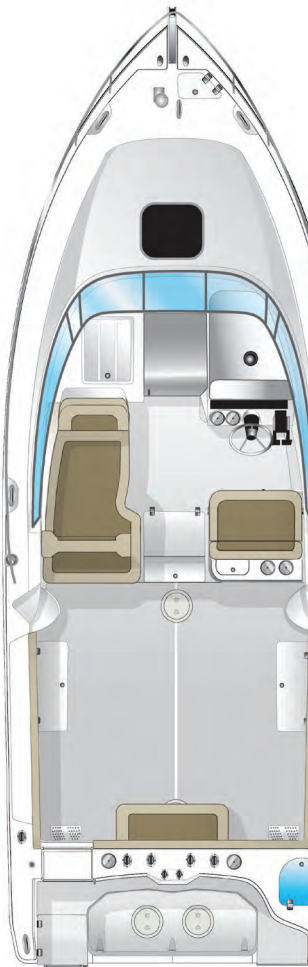

- Recessed SST Cup Holders (6)
- Remote Spot Light on Hard Top
- SailTech Composite Full Length Transom
- SailTech Foam Filled Fiberglass Stringer System
- Stainless Steering Wheel w/ Power Knob
- Walk Thru Transom Door with Wave Guard Step
- Windlass w/ SST Polished Anchor Roller, SST Polished Scuff Plate, SST Polished Anchor, Rode and Chain
- Yamaha 10 Micron Fuel Filter / Water Separator w/ SS Base

- Cabin Amenities
  - Cabin V-Berth Cushions and Filler Cushions
  - Flip Up Bunk Beds
  - Fresh Water Marine Head w/ Holding Tank & Pump Out & Overboard Discharge
  - Galley Faucet at Sink
  - Hot Point Stove / Sink / Freshwater / Table Microwave
  - Mid-Ship Berth
  - SST Port Lights (4)
  - Stand-up Head Compartment

- Electrical
  - 12 Volt DC Accessory Plug
  - Accessory Switch Panel w/Circuit Breakers
  - Cabin Lighting
  - Compass
  - Full Digital Instrumentation
  - Heavy Duty High Performance Trim Tabs with Indicators & Auto Retract Feature
  - LED Interior Cockpit & Bilge Lighting
  - LED Navigational Bow & Anchor Light
  - Remote Control For Stereo at Helm
  - Shore Power w/ Built-In Battery Charger
  - Stereo (Bluetooth Capable, Satellite Ready, AM/FM w/4 Speakers)
  - Trim Tabs / High Performance / Heavy Duty With Indicator Switch & Built In Auto Retract Feature
  - VSR Battery Charging System
  - Windshield Wipers (Pair)

- Fishing
  - Baitwell w/ LED Lighting (30 gal. Transom)
  - Built-In Tackle Storage (Mid-Ship)

- Hardware
  - Fender Cleats Aft (2)
  - Flush Mount Cleats
  - Flush Mount Hinges and Latches & Deck Plates
  - Heavy Duty Stainless Steel Bow & Stern Eyes
  - Heavy Duty Stainless Steel Rub Rail
  - Marine Grade Stainless Steel Hardware
  - Sailfish Engraved Transom Plate
  - Stainless Steel & Bronze Thru Hull Fittings
  - Stainless Steel Full Bow Rail
  - Stainless Steel Propeller(s)
  - Stainless Steel Rod Holders (10)

- Head
  - Finished Fiberglass Head
  - Head Compartment Lighting
  - Lockable Head Door
  - Mirror
  - Pull Out Shower w/Sink in Head

- Helm
  - Large Dash Area (Capable of flush mounting 15" Screen)
- Plumbing
  - Automatic Bilge Pump (2 - 2000 GPH Aft - 750 GPH Forward)
  - Built In Rigging Tubes (From Bilge to Helm with pull tapes)
  - Freshwater Showers (2) - Transom And Head
  - High Speed Livewell Pickup
  - Raw Water Wash Down
  - Self Bailing Cockpit (w/ (4) 2" Drains with Collector Box)
  - Sink with Faucet (In Cabin)

- Seating
  - Oversized Captain's Chair With Flip Up Bolster
  - Passenger Lounge Seat

### STANDARD FEATURES

- Boat
  - 6 Standard Hull Colors
  - Boarding Ladder (4 step with grab handle)
  - Built In Rigging Tubes (From Bilge to Helm with pull tapes)
  - Carbon Fiber & Kevlar® Reinforced Deck & Hull
  - Closed Cell Foam Flotation
  - Cockpit Bolsters
  - Exclusive Dot Matrix Non-Skid
  - Exclusive VDS Hull Design (Variable Deadrise Stepped Hull)
  - Full Hull Color
  - Hard Top w/ Storage, Lights and Rod Holders
  - Hydraulic Steering w/ Tilt Wheel & Power Knob
  - In-Floor Fish Boxes (Insulated w/ Advanced Vacuum Pump, Non-Macerated)
  - Mercury Verado Fuel Filter / Water Separator
  - Oversized Bilge Access
  - Power Assist Steering

- Storage
  - Battery Storage (Bilge Compartment)
  - Recessed Rod Storage - Port & Starboard
  - Storage Center w/ Pull Out Drawers
  - Tackle Storage Port & Starboard

### OPTIONS

- Boat Options
  - Air Conditioning / Heat & Air
  - CommandLink Plus (C Series Motors Only)
  - Generator Gas EFI 5KW
  - Mid-Ship Fender Cleats (2)
  - Power Assist Steering (Y) (Std. on T300HP)
  - Underwater LED Lights (3)
  - VesselView 7"

- Electrical Options
  - Garmin B60 Airmar Thru Hull Transducer w/o CHIRP
  - Garmin B75M Airmar Thru Hull Transducer w/ CHIRP
  - Garmin GPSMap 1042xsv w/o Transducer
  - Garmin GPSMap 7612xsv w/o Transducer
  - Garmin Radar Cable & Power Cable 30'
  - Garmin VHF Radio & Antenna
  - LED Lighted Speakers
  - Solar Battery Charger, Hard Top Only

- Seating Options
  - 58" Aft Folding Seat
  - Rear Cooler Seat - 125 Qt. Yeti

- Optional Packages
  - **Over Night Package**
  - Generator Gas EFI 5KW & Air Conditioner
  - **Pilot House Package**
  - Hard Top w/ Hard Frame Windshield w/ Wipers, Window Defroster & Back Drop Curtains

- Engine Options
  - Yamaha
  - Twin F250UCA
  - Twin F300UCA
  - Mercury
  - Twin 250XXL Verado
  - Twin 300XXL Verado
  - Twin 350XXL Verado
  - White Painted Motors (N/A on 250XXL)

## 270WAC

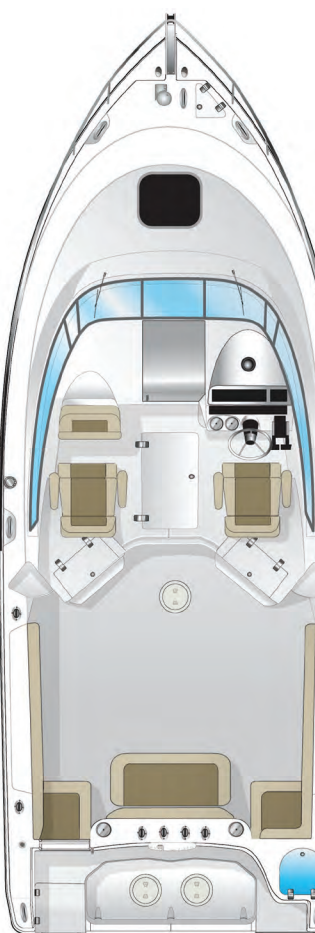

- Holder
  - Walk Thru Transom Door with Wave Guard Step
  - Yamaha 10 Micron Fuel Filter / Water Separator w/ SS Base
- Cabin Amenities
  - Cabin Butane Stove / Sink / Freshwater / Table
  - Cabin V-Berth Cushions and Filler Cushions
  - Mirror
  - Stand-up Head Compartment

- Electrical
  - 12 Volt DC Accessory Plug
  - Accessory Switch Panel w/Circuit Breakers
  - Cabin Lighting
  - Compass
  - Full Digital Instrumentation
  - Heavy Duty High Performance Trim Tabs with Indicators & Auto Retract Feature
  - LED Interior Cockpit & Bilge Lighting
  - LED Navigational Bow & Anchor Light
  - Remote Control For Stereo at Helm
  - Stereo (Bluetooth Capable, AM/FM w/4 Speakers)
  - VSR Battery Charging System

- Fishing
  - Baitwell w/ LED Lighting (30 gal. Transom)
  - Built-In Tackle Storage Port Side (Midship)

- Hardware
  - Fender Cleats Aft (2)
  - Flush Mount Cleats
  - Flush Mount Hinges and Latches & Deck Plates
  - Heavy Duty Stainless Steel Bow & Stern Eyes
  - Heavy Duty Stainless Steel Rub Rail
  - Marine Grade Stainless Steel Hardware
  - Sailfish Engraved Transom Plate
  - Stainless Steel & Bronze Thru Hull Fittings
  - Stainless Steel Full Bow Rail
  - Stainless Steel Propeller(s)
  - Stainless Steel Rod Holders (4)

- Head
  - Finished Fiberglass Head
  - Head Compartment Lighting
  - Lockable Head Door
  - Mirror

- Helm
  - Large Dash Area (Capable of flush mounting 12" Screen)

- Plumbing
  - Automatic Bilge Pump (2000 GPH Aft and 750 GPH Forward)
  - Freshwater Showers, (4) - Transom, Bait Prep Sink, Galley Sink and Head Sink
  - High Speed Livewell Pickup
  - Porta Potti
  - Pull Out Shower in Head
  - Pull Out Transom Shower
  - Raw Water Wash Down
  - Self Bailing Cockpit

- Seating
  - Captain's Chair Foot Rests
  - Captain's Chairs
  - Deluxe Passenger Chair

- Storage
  - Anchor Locker (w/ Bow Roller)
  - Battery Storage (Bilge Compartment)
  - Insulated - Fish Box with Overboard Drain (Midship)
  - Recessed Rod Storage - Port & Starboard
  - Tackle Storage Center w/ Pull Out Drawers

### OPTIONS

- Electrical Options
  - Garmin B60 Airmar Thru Hull Transducer w/o CHIRP
  - Garmin B75M Airmar Thru Hull Transducer w/ CHIRP
  - Garmin GPSMap 1042xsv w/o Transducer
  - Garmin GPSMap 7612xsv w/o Transducer
  - Garmin Radar Cable & Power Cable 30'
  - Garmin VHF Radio & Antenna
  - LED Lighted Speakers

### STANDARD FEATURES

- Boat
  - 6 Standard Hull Colors
  - Boarding Ladder (4 step with grab handle)
  - Built-in 48qt. Igloo Ice Cube™ Cooler
  - Built In Rigging Tubes (From Bilge to Helm with pull tapes)
  - Carbon Fiber & Kevlar® Reinforced Deck & Hull
  - Closed Cell Foam Flotation
  - Cockpit Bolsters
  - Cockpit Toe Rails
  - Exclusive Dot Matrix Non-Skid
  - Exclusive VDS Hull Design (Variable Deadrise Stepped Hull)
  - Full Hull Color
  - Hydraulic Steering w/ Tilt Wheel & Power Knob
  - Mercury Verado Fuel Filter / Water Separator
  - Oversized Bilge Access
  - Recessed SST Cup Holders (6)
  - SailTech Composite Full Length Transom
  - SailTech Foam Filled Fiberglass Stringer System
  - Stainless Steering Wheel w/ Power Knob
  - Transom Mounted Tool & Washdown Hose

# FEATURES OPTIONS

## 240WAC



- Yamaha 10 Micron Fuel Filter / Water Separator w/ SS Base
- Cabin Amenities
  - Cabin Butane Stove / Sink / Freshwater / Table
  - Cabin Lighting
  - Cabin V-Berth Cushions
  - Mirror
- Electrical
  - 12 Volt DC Accessory Plug
  - Accessory Switch Panel w/Circuit Breakers
  - Cabin Lighting
  - Compass
  - Full Digital Instrumentation
  - LED Interior Cockpit & Bilge Lighting
  - LED Navigational Bow & Anchor Light
  - Remote Control For Stereo at Helm
  - Stereo (Bluetooth Capable, Satellite Ready, AM/FM w/4 Speakers)
  - VSR Battery Charging System

- Fishing
  - Baitwell w/ LED Lighting (30 gal. Transom)
  - Built-In Tackle Storage (Midship)

- Hardware
  - Bow Anchor Roller
  - Fender Cleats Aft (2)
  - Flush Mount Hinges and Latches & Deck Plates
  - Heavy Duty Stainless Steel Bow & Stern Eyes
  - Heavy Duty Stainless Steel Rub Rail
  - Marine Grade Stainless Steel Hardware
  - Sailfish Engraved Transom Plate
  - Stainless Steel & Bronze Thru Hull Fittings
  - Stainless Steel Full Bow Rail
  - Stainless Steel Propeller(s)
  - Stainless Steel Rod Holders (4)

- Helm
  - Large Dash Area (Capable of flush mounting 12" Screen)

- Plumbing
  - Automatic Bilge Pump (2000 GPH Aft and 750 GPH Forward)
  - Freshwater Showers
  - Transom And Cabin
  - High Speed Livewell Pickup
  - Porta Potti
  - Raw Water Wash Down
  - Self Bailing Cockpit
  - Sink with Fresh Water Faucet (In Cabin)

- Seating
  - Captain's Chair Foot Rests
  - Captain's Chairs w/ Removable Cushions (2)

### OPTIONS

- Boat Options
  - CommandLink Plus (C Series Motors Only)
  - Polished SST Anchor Scuff Plate
  - Power Assist Steering (M) (Standard w/ Verado)
  - Power Assist Steering (Y)
  - Remote Spot Light for Hard Top
  - SSI Tackle Station (Additional)
  - Trim Tabs w/ Indicator Switch & Built In Retractor
  - Underwater LED Lights (3)
  - VesselView 7"
  - Windlass w/ Polished Roller, SST Scuff Plate, Anchor, Rode & Chain
  - Windshield Wipers (pair)
- Electrical Options
  - Built-In 3 Bank Battery Charger w/ LED Readout
  - Garmin B60 Airmar Thru Hull Transducer w/o CHIRP
  - Garmin B75M Airmar Thru Hull Transducer w/ CHIRP
  - Garmin GPSMap 1042xsv w/o Transducer
  - Garmin VHF Radio & Antenna
  - LED Lighted Speakers
  - Solar Battery Charger, Hard Top Only
  - Remote Spot Light for Hard Top Only

### STANDARD FEATURES

- Boat
  - Anchor Locker (w/ Bow Roller)
  - Boarding Ladder (4 step with grab handle)
  - Built In Rigging Tubes (From Bilge to Helm with pull tapes)
  - Carbon Fiber & Kevlar® Reinforced Deck & Hull
  - Closed Cell Foam Flotation
  - Cockpit Bolsters
  - Exclusive Dot Matrix Non-Skid
  - Exclusive VDS Hull Design (Variable Deadrise Stepped Hull)
  - Faucet at Sink
  - Hydraulic Steering w/ Tilt Wheel & Power Knob
  - In-Floor Fish Box (w/ Advanced Vacuum Pump, Non-Macerated (2))
  - Mercury Verado Fuel Filter / Water Separator
  - Oversized Bilge Access
  - Recessed Rod Storage - Port & Starboard
  - Recessed SST Cup Holders (6)
  - SailTech Composite Full Length Transom
  - SailTech Foam Filled Fiberglass Stringer System
  - Stainless Steering Wheel w/ Power Knob
  - Transom Mounted Tool & Washdown Hose Holder
  - Walk Thru Transom Door with Wave Guard Step

# FEATURES OPTIONS

## 220WAC



- Cabin Lighting
- Compass
- Dual Battery Switch
- Full Digital Instrumentation
- LED Interior Cockpit & Bilge Lighting
- LED Navigational Bow & Anchor Light
- Remote Control For Stereo at Helm
- Stereo (Bluetooth Capable, AM/FM w/4 Speakers)
- Trim Tabs w/ Indicator Switch & Built In Auto Retract Feature
- 12 Volt DC Accessory Plug

- Fishing**
- Baitwell w/ LED Lighting - 25 gal. Transom
- Built-In Tackle Storage (Aft Under Transom Door)

- Hardware**
- Bow Anchor Roller
- Fender Cleats Aft (2)
- Flush Mount Hinges and Latches & Deck Plates
- Heavy Duty Stainless Steel Bow & Stern Eyes
- Heavy Duty Stainless Steel Rub Rail
- Marine Grade Stainless Steel Hardware
- Sailfish Engraved Transom Plate
- Stainless Steel & Bronze Thru Hull Fittings
- Stainless Steel Full Bow Rail
- Stainless Steel Propeller(s)
- Stainless Steel Rod Holders (4)

- Helm**
- Large Dash Area (Capable of flush mounting 10" Screen)

- Plumbing**
- Automatic Bilge Pump (2000 GPH)
- Freshwater Showers (2) - Transom and Cabin
- High Speed Livewell Pickup
- Porta Potti
- Raw Water Wash Down
- Self Bailing Cockpit
- Sink with Faucet (In Cabin)

- Storage**
- Anchor Locker (w/ Bow Roller)
- Battery Storage (Bilge Compartment)
- Insulated - Fish Box / Storage (Leaning Post)
- Recessed Rod Storage - Port & Starboard

- Seating**
- Leaning Post (LP 4) Fiberglass w/ Fish Box & Cooler

### OPTIONS

- Boat Options**
- 25 qt. Igloo Coolers (pr)
- Bimini Top
- CommandLink Plus (C Series Motors Only)
- Leaning Post Cover
- Underwater LED Lights (2)
- VesselView 4"

- Electrical Options**
- Built-In 2 Bank Battery Charger
- Garmin B60 Airmar Thru Hull Transducer w/o CHIRP
- Garmin B75M Airmar Thru Hull Transducer w/ CHIRP
- Garmin B75M Airmar Thru Hull Transducer w/ CHIRP
- Garmin GPSMap 741xs w/o Transducer
- Garmin GPSMap 840xs w/o Transducer
- Garmin VHF Radio & Antenna
- Solar Battery Charger, Hard Top Only

- Hardware Options**
- Mid-Ship Fender Cleats (2)
- Ski Tow Bar (Retractable)

- Seating Options**
- Rear Jump Seats

- Optional Packages**
- Offshore Tournament Pack**
- Hard Top, Powder Coated w/ Built-In Radio Box, Flush Mount Cleats & Transom Rod Holders (3)
- Inshore Tournament Pack**
- Built-In Battery Charger, Deluxe Fish Seat & Pedestal

- Engine Options**
- Yamaha
- F150XB
- F200XB
- F200XCA
- Mercury
- 150XL
- 200XL Verado

- Electrical**
- Accessory Switch Panel w/Circuit Breakers

## 2100BB

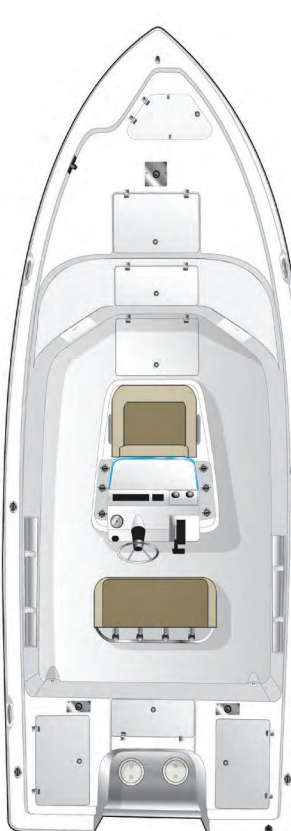

### STANDARD FEATURES

- Boat**
- Anchor Locker
- Built In Rigging Tubes
- (From Bilge to Helm with pull tapes)
- Carbon Fiber & Kevlar® Reinforced Deck & Hull
- Closed Cell Foam Flotation
- Exclusive Dot Matrix Non-Skid
- Hydraulic Steering w/ Tilt Wheel & Power Knob
- Mercury Verado Fuel Filter / Water Separator
- Recessed SST Cup Holders (1)
- SailTech Composite Full Length Transom
- SailTech Foam Filled Fiberglass Stringer System
- Stainless Steering Wheel w/ Power Knob
- Yamaha 10 Micron Fuel Filter / Water Separator w/ SS Base

- Electrical**
- 12 Volt DC Accessory Plug
- Accessory Switch Panel w/Circuit Breakers
- Compass
- Dual Battery Switch
- Electric Horn
- Full Digital Instrumentation
- LED Interior Cockpit Lighting
- LED Navigational Bow & Anchor Light

- Fishing**
- Baitwell (20 gal. Aft)
- Built-In Tackle Storage (2 Forward)
- Insulated Bow Fish Box (5) - Drains Overboard

- Release Livewell (30 gal. Port Aft)
- Hardware**
- Flush Mount Hinges and Latches & Deck Plates
- Heavy Duty Stainless Steel Bow & Stern Eyes
- Heavy Duty Stainless Steel Rub Rail
- Marine Grade Stainless Steel Hardware
- Sailfish Engraved Transom Plate
- Stainless Steel Over Composite & Bronze Thru Hull Fittings
- Stainless Steel Propeller(s)
- Stainless Steel Rod Holders (8)
- Wind Screen w/ Stainless Steel Grab Rail

- Helm**
- Large Dash Area (Capable of flush mounting 7" Screen)

- Plumbing**
- Automatic Bilge Pump (1100 GPH)
- High Speed Livewell Pickup
- Raw Water Wash Down
- Self Bailing Cockpit

- Seating**
- Baitwell (16 gal. Console w/ Seat Cushions)
- Captain's Chairs w/ Removable Cushions (2)

- Storage**
- Battery Storage (Aft Starboard)
- Casting Deck Storage Box
- In-Floor Storage (Forward of Console)
- Recessed Rod Storage - Port & Starboard

### OPTIONS

- Boat Options**
- Built-In 2 Bank Battery Charger
- Flush Mount Cleats
- Mid-Ship Fender Cleats (2)
- Poling Platform
- Powder Coated Leaning Post & T-Top
- Swim Platform w/ Ladder
- T-Top w/ Spreader Light
- Trim Tabs w/ Indicator Switch & Built in Retractor
- Underwater LED Lights (2)

- Electrical Options**
- Garmin 547xs w/o Transducer
- Garmin B60 Airmar Thru Hull Transducer w/o CHIRP
- Garmin EchoMap 54dv US Blue Chart w/ P79 Transducer
- Garmin VHF Radio & Antenna
- Jensen Stereo w/2 Speakers
- LED Lighted Speakers
- Trolling Motor Panel

- Seating Options**
- Deluxe Fish Seat & Pedestal
- Front Jump Seat Cushions
- LP2 (Leaning Post w/ Rod Holders & Removable Backrest)
- Rear Jump Seat Cushions

- Optional Packages**
- Sport Pack**
- Trolling Motor Panel, 2 Additional Rod Holders & Rear Jump Seat Cushions
- Pro Fish Pack**
- (Includes Sport Pack), LP2 w/ Removable Backrest, Front Jump Seat Cushions & Flush Mount Cleats
- Inshore Tournament Pack**
- Built-In Battery Charger, Deluxe Fish Seat & Pedestal

- Engine Options**
- Yamaha
- F150XB
- F200XB
- F200XCA
- Mercury
- 150XL
- 200XL Verado

- Fishing**
- Built-In Tackle Storage (2 Forward)
- Insulated Bow Fish Box (5) - Drains Overboard
- Release Livewell (30 gal. Port Aft)

## 1900BB

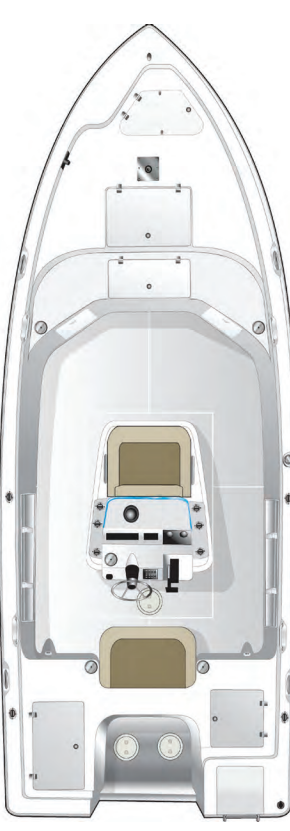

### STANDARD FEATURES

- Boat**
- Anchor Locker
- Boarding Ladder (3 Step)
- Built In Rigging Tubes
- (From Bilge to Helm with pull tapes)
- Carbon Fiber & Kevlar® Reinforced Deck & Hull
- Closed Cell Foam Flotation
- Exclusive Dot Matrix Non-Skid
- Hydraulic Steering w/ Tilt Wheel & Power Knob
- Recessed SST Cup Holders (5)
- SailTech Composite Full Length Transom
- SailTech Foam Filled Fiberglass Stringer System
- Stainless Steering Wheel w/ Power Knob
- Yamaha 10 Micron Fuel Filter / Water Separator w/ SS Base

- Electrical**
- 12 Volt DC Accessory Plug
- Accessory Switch Panel w/Circuit Breakers
- Compass
- Dual Battery Switch
- Electric Horn
- Full Digital Instrumentation
- LED Interior Cockpit Lighting
- LED Navigational Bow & Anchor Light

- Fishing**
- Built-In Tackle Storage (2 Forward)
- Insulated Bow Fish Box (5) - Drains Overboard
- Release Livewell (30 gal. Port Aft)

- Hardware**
- Flush Mount Hinges and Latches & Deck Plates
- Heavy Duty Stainless Steel Bow & Stern Eyes
- Heavy Duty Stainless Steel Rub Rail
- Marine Grade Stainless Steel Hardware
- Sailfish Engraved Transom Plate
- Stainless Steel Over Composite & Bronze Thru Hull Fittings
- Stainless Steel Propeller(s)
- Stainless Steel Rod Holders (8)
- Wind Screen with Stainless Steel Grab Rail

- Plumbing**
- Automatic Bilge Pump (1100 GPH)
- High Speed Livewell Pickup
- Raw Water Wash Down
- Self Bailing Cockpit

- Seating**
- Baitwell (16 gal. Console w/ Seat Cushions)
- Captain's Chairs w/ Removable Cushions (2)

- Storage**
- Battery Storage (Under Helm Seat)
- Casting Deck Storage Box
- Recessed Rod Storage - Port & Starboard

### OPTIONS

- Electrical Options**
- Garmin B60 Airmar Thru Hull Transducer w/o CHIRP
- Garmin EchoMap 54dv US Blue Chart w/ P79 Transducer
- Garmin GPSMAP 547xs w/o Transducer
- Garmin VHF Radio & Antenna
- Jensen Stereo w/2 Speakers
- LED Lighted Speakers
- Trolling Motor Panel

- Boat Options**
- Built-In 2 Bank Battery Charger
- Flush Mount Cleats
- Mid-Ship Fender Cleats (2)
- Poling Platform
- T-Top w/ Spreader Light
- Trim Tabs w/ Indicator Switch & Built in Retractor
- Underwater LED Lights (2)

- Seating Options**
- Cooler Seat Backrest
- Deluxe Fish Seat & Pedestal
- Front Jump Seat Cushions
- Leaning Post w/ Backrest and Cooler
- Rear Jump Seat Cushions

- Optional Packages**
- Sport Pack**
- Trolling Motor Panel, 2 Additional Rod Holders & Rear Jump Seat Cushions
- Inshore Tournament Pack**
- Built-In Battery Charger, Deluxe Fish Seat & Pedestal

- Engine Options**
- Yamaha
- F115XB
- F150XB
- Mercury
- 115ELPT
- 150XL

- Electrical**
- 12 Volt DC Accessory Plug
- Accessory Switch Panel w/Circuit Breakers
- Compass
- Dual Battery Switch
- Electric Horn
- Full Digital Instrumentation
- LED Interior Cockpit Lighting
- LED Navigational Bow & Anchor Light

- Fishing**
- Built-In Tackle Storage (2 Forward)
- Insulated Bow Fish Box (5) - Drains Overboard
- Release Livewell (30 gal. Port Aft)

<b>220CC</b>	Standard 29 13
	Optional 10 21 25 28
<b>220WAC</b>	Standard 7
	Optional 10 28
<b>241CC</b>	Standard 17 20 29
	Optional 6 10 21 24 25
<b>242CC</b>	Standard 29 13
	Optional 6 7 10 21 25 28
<b>240WAC</b>	Standard 29
	Optional 19 26 28
<b>245DC</b>	Standard 9 15 20 29
	Optional 27
<b>270CC</b>	Standard 29 18
	Optional 1 2 3 4 5 10 19 21 25 26 28
<b>275DC</b>	Standard 11 15 19 29
	Optional 27
<b>270WAC</b>	Standard 29
	Optional 19 26 28 29
<b>290CC</b>	Standard 1 18
	Optional 2 3 4 5 10 19 21 25 26 28
<b>320CC</b>	Standard 1 18
	Optional 2 3 4 5 19 21 22 25
<b>320WAC</b>	Standard 12 16
	Optional 19 22
<b>325DC</b>	Standard 8 14 23 29
	Optional 27
<b>1900BB</b>	Standard 29
	Optional 29
<b>2100BB</b>	Standard 29
	Optional 10 29

# SEATING OPTIONS

- Helm & Leaning Post Seating
- Forward Helm Seating
- Aft Seating & Covers

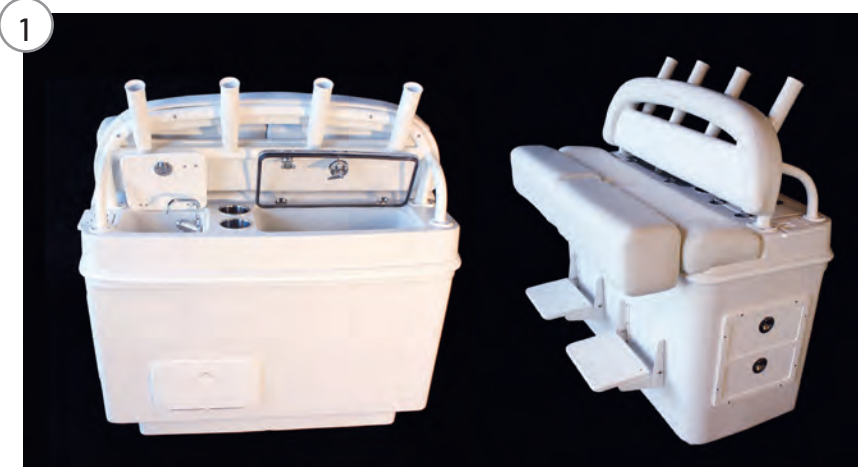

35 Gallon Livewell Leaning Post with Flip Up Bolsters



Capt. Chair Leaning Post w/ Expanded Tackle Stations



35 Gallon Livewell Leaning Post with Capt Chairs



Entertainment Leaning Post with Capt Chairs



Twin Tackle Station Leaning Post with Capt Chairs



LP9 Leaning Post w/ Baitwell, Flip Out Storage. LP10 No Baitwell w/ Rear Storage

### STANDARD FEATURES

- Boat**
- Boarding Ladder (3 step)
- Built In Rigging Tubes (From Bilge to Helm with pull tapes)
- Carbon Fiber & Kevlar® Reinforced Deck & Hull
- Closed Cell Foam Flotation
- Cockpit Bolsters
- Exclusive Dot Matrix Non-Skid
- Exclusive VDS Hull Design (Variable Deadrise Stepped Hull)
- Faucet at Sink
- Hydraulic Steering w/ Tilt Wheel & Power Knob
- Mercury Verado Fuel Filter / Water Separator
- Recessed SST Cup Holders (5)
- SailTech Composite Full Length Transom
- SailTech Foam Filled Fiberglass Stringer System
- Stainless Steering Wheel w/ Power Knob
- Walk Thru Transom Door with Wave Guard Step
- Yamaha 10 Micron Fuel Filter / Water Separator w/ SS Base

- Cabin Amenities**
- Cabin 25Qt. Cooler
- Cabin Butane Stove / Sink / Freshwater / Table
- Cabin V-Berth Cushions and Filler Cushions
- Mirror
- Electrical**
- Accessory Switch Panel w/Circuit Breakers

For a complete listing of standard features and options visit [sailfishboats.com](http://sailfishboats.com).

SEATING OPTIONS



LP4 with Backrest and Igloo Cooler



325DC Helm Seat



245DC Helm Seat



LP2 with Removable Backrest



275DC Capt Chair



320WAC Capt Chair



Forward Helm Seat



325DC Passenger Seat



245DC & 275DC Three Position Lounge



320WAC Passenger Lounge



236CC Forward Seat w/ Built-In Cooler



Forward Cooler Seat



Aft Folding Seat



236CC & 245DC Aft Seat w/ Flip Up Bolster



Leaning Post Cover - Available for 220CC thru 320CC



Aft Cooler Seat 125 Qt Yeti



Aft Stowaway Seat



236CC Rear Jump Seat



Console Cover - Available for 220CC thru 320CC



Aft Cooler Seat 75 Qt Yeti



Port, Aft & Starboard Stowaway Seat



Jump Seat

29 Not shown

- Standard Captain's Chair
- FWD Bay Boat Seat
- 240WAC Helm Chairs
- 270WAC Captain's Chair
- 270 WAC Passenger Chair & Passenger Lounge
- Bay Boat FWD & Aft Jump Seats
- 1900BB Leaning Post w/ Backrest
- 1900BB Cooler Seat Backrest
- 1900BB Cooler Helm Seat - 72Qt. Igloo
- Deluxe Fishing Seat and Pedestal
- 245DC Rear Aft Facing Starboard Seat
- 325DC Fold Out Aft Passenger Seat 27'

For complete seating information visit [www.SailfishBoats.com](http://www.SailfishBoats.com).

SEATING OPTIONS



## TOP OPTIONS

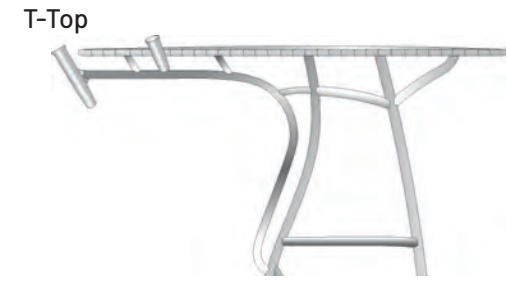

T-Top

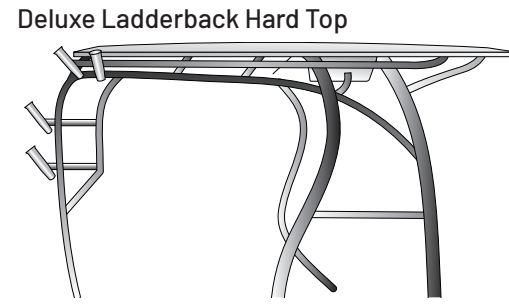

Deluxe Ladderback Hard Top

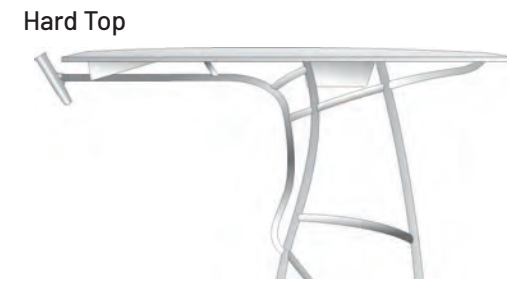

Hard Top

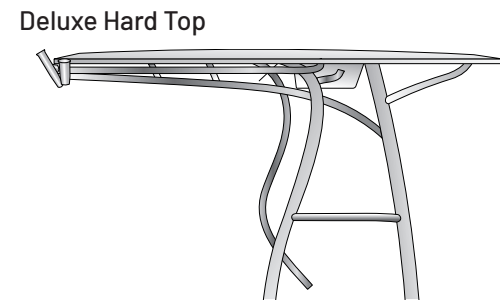

Deluxe Hard Top



241CC Hard Top

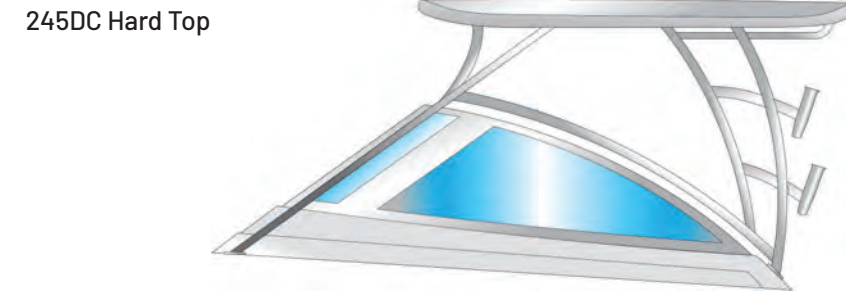

245DC Hard Top

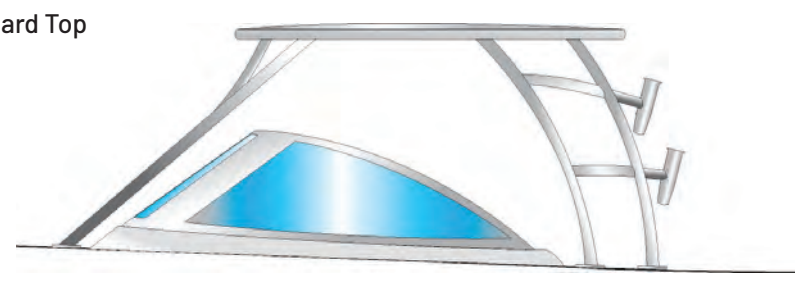

275DC Hard Top

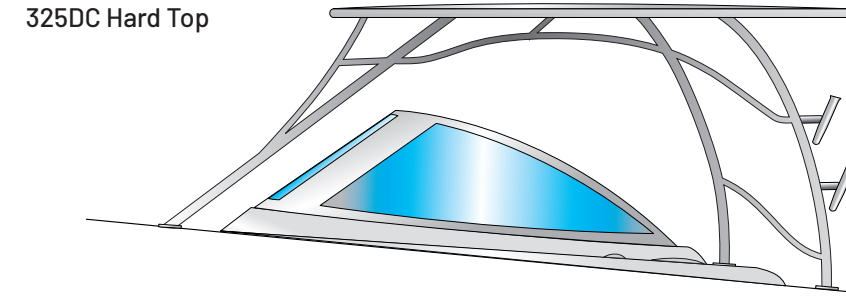

325DC Hard Top



## HULL COLORS

Move up from standard White with any of the seven exciting color gelcoats to choose from, each masterfully applied and polished to the brightest possible shine. Solid color or two-tone gelcoat hulls are available.

### BASIC COLORS



White (Standard Color)



Bone

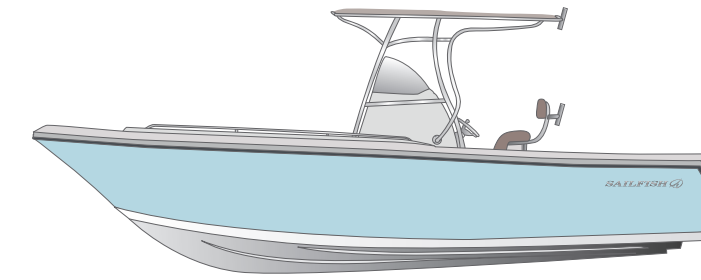

Province Blue



Ice Blue



Aqua Mist

### PREMIUM COLORS



Black



Storm Grey



Deep Blue





Manufactured by  
SEMINOLE MARINE GROUP  
2501 Industrial Park Drive • Cairo, GA 39828

[www.Sailfishboats.com](http://www.Sailfishboats.com)

Seminole Marine, Inc. reserves the right to discontinue models or change prices, specifications, materials, equipment, color or design at any time without incurring obligation. Weight and dimensions of all models are approximate and may vary. Options are subject to change. Photographs in this catalog were shot under supervised conditions with professional models and drivers and boats shown may contain optional equipment.