

can-am®



ATV PRODUCT SPEC BOOK

**VEHICLE SPECIFICATIONS, ACCESSORIES,
PARTS & MAINTENANCE AND APPAREL**

2026

TABLE OF CONTENTS

ATV ACCESSORY COMPATIBILITY GUIDE	5
UNITS COMPARATIVE CHART	6
G2, G2L, G2S ACCESSORIES	21
G3, G3L ACCESSORIES	55
PARTS AND MAINTENANCE	93
CAN-AM APPAREL	115

Pricing is subject to change due to various taxes, tariffs, or duties which may be applicable on certain products. BRP reserves the right to change the prices without incurring any obligations.

CANAMOFFROAD.COM

© 2025 Bombardier Recreational Products Inc. (BRP). All rights reserved. ®, TM and the BRP logo are trademarks of BRP or its affiliates. In the USA, products are distributed by BRP US Inc. All other trademarks are the property of their respective owners. BRP reserves the right to discontinue or change specifications, prices, designs, features, models or equipment without incurring obligation. Some models shown may include optional equipment. Product performance may vary depending on external factors. BRP recommends that all SxS drivers take a training course. See your dealer. SxS can be hazardous to operate. Never exceed the SxS's passenger capacity. All SxS models are meant to be used by drivers aged 16 and older. Read the operator's guide. Follow all instructional and safety material and observe applicable laws and regulations. SxS are for off-road use only; never ride on paved surfaces or public roads. For your safety, the operator and passenger(s) must wear a helmet, eye protection and applicable protective clothing. Always remember that riding and alcohol/drugs don't mix. Never engage in stunt driving. Avoid excessive speed and be particularly careful on difficult terrain. Always ride responsibly and safely. See your authorized BRP dealer for details and visit <https://can-am.brp.com/>. Printed in Canada.



IF WE SELL IT, WE STAND BY IT.

BRP Limited Warranty*
for new Parts, Accessories
and Riding Gear

1-year limited warranty**

- Genuine BRP Parts and Accessories installed by you or your authorized BRP dealer
- Aftermarket Products sold through BRP
- Riding Gear

4-year limited warranty**

- Helmets

**GET ALL THE DETAILS FROM
YOUR CAN-AM OFF-ROAD DEALER**

* Purchased at an authorized BRP dealership/distributor or on a BRP-authorized online store. Other exclusions may apply; see complete limited warranty or contact your Can-Am Off-Road authorized dealer. This limited warranty does not apply to factory-installed accessories and Evinrude parts and accessories.

** Unless otherwise stipulated or required by law.



CUSTOMIZING MADE EASY

- 1 SELECT THE MODEL.**
- 2 SELECT THE PACKAGE.**
- 3 CUSTOMIZE COLOR, ENGINE, AND ACCESSORIES (OR ACCESSORY BUNDLES) FOR YOUR VEHICLE.**
- 4 CLICK “SAVE” OR “SEND TO DEALER.”**

BUILD YOURS NOW

If you can dream it, you can build it. And ride it. Creating a Can-Am vehicle tailor-made for our riders' needs has never been easier. Scan the QR code and follow the step-by-step.



We've made things super simple.

- Check your model year
- Choose engine and model
- Learn your **PLATFORM CODE**

This **PLATFORM CODE** will let you know at a glance if the accessory is compatible with your vehicle.



G3L 6x6



G3 6x6



G3L



G3



G2L



G2S

ATV ACCESSORY COMPATIBILITY GUIDE

Model year	Model	Engine configuration	Platform code	
2016	Outlander L	450, 570	G2L	
	Outlander	570, 650, 850, 1000	G2	
	Outlander L MAX	450, 570	G2L MAX	
	Outlander MAX	570, 650, 850, 1000	G2 MAX	
	6x6	650, 1000	G2 MAX	
	Renegade	500, 800, 1000	G2S	
2017	Outlander	450, 570	G2L	
	Outlander	650, 850, 1000	G2	
2018	Outlander MAX	450, 570	G2L MAX	
	Outlander MAX	650, 850, 1000	G2 MAX	
	6x6	650, 1000	G2 MAX	
	Renegade	570, 800, 1000	G2S	
	2019	Outlander	450, 570	G2L
		Outlander	650, 850, 1000R	G2
2020	Outlander MAX	450, 570	G2L MAX	
	Outlander MAX	650, 850, 1000R	G2 MAX	
2021	6x6	450	G2L MAX	
	6x6	650, 1000	G2 MAX	
2022	Renegade	570, 650, 850, 1000R	G2S	
	Outlander	450, 570	G2L	
2023	Outlander	650, 850, 1000R	G2	
	Outlander MAX	450, 570	G2L MAX	
	Outlander MAX	650, 850, 1000R	G2 MAX	
	6x6	450	G2L MAX	
	6x6	650, 1000	G2 MAX	
	Renegade	650, 1000R	G2S	
	Outlander	500, 700	G3L	
	Outlander PRO	HD5, HD7	G3L	
	Outlander MAX	500, 700	G3L MAX	
	2024	Outlander	500, 700	G3L MAX
		Outlander	500, 700	G3L
Outlander		850, 1000R	G2	
Outlander PRO		HD5, HD7	G3L	
Outlander MAX		500, 700	G3L MAX	
Outlander MAX		850, 1000R	G2 MAX	
6x6		450	G2L MAX	
6x6		650, 1000	G2 MAX	
Renegade		650, 1000R	G2S	
2025		Outlander	500, 700	G3L
		Outlander	850, 1000R	G3
	Outlander PRO	HD5, HD7	G3L	
	Outlander MAX PRO	HD7	G3L MAX	
	Outlander MAX	500, 700	G3L MAX	
	Outlander MAX	850, 1000R	G3 MAX	
	6x6	450	G2L MAX	
	6x6	650, 1000	G2 MAX	
	Renegade	650, 1000R	G2S	
	2026	Outlander	500, 700	G3L
		Outlander	850, 1000R	G3
Outlander PRO		HD5, HD7	G3L	
Outlander MAX PRO		HD7	G3L	
Outlander MAX		500, 700	G3L MAX	
Outlander MAX		850, 1000R	G3 MAX	
Outlander Electric			G3L	
Outlander MAX Electric			G3L MAX	
6x6		700	G3L MAX	
6x6		850, 1000R	G3 MAX	
Renegade		650, 1000R	G2S	



OUTLANDER PRO***

COLOR OPTIONS		Desert Tan Compass Green	
ENGINES	Type	HD5 40 hp / 37 lb-ft, Rotax® ACE (Advanced Combustion Efficiency) 650 cc, single cylinder, liquid-cooled	HD7 50 hp / 41 lb-ft, Rotax® ACE (Advanced Combustion Efficiency) 650 cc, single cylinder, liquid-cooled
	Fuel Delivery System	Electronic Fuel Injection (EFI)	
	Transmission	pDrive™ primary CVT with work calibration Extra low L / H / N / R / P	
	Drive Train	Selectable 2WD / 4WD with Visco-Lok [†] auto-locking front differential	
	Driving Assistance	Speed limiter	Work / Standard / Sport modes Intelligent Engine Braking (IEB™) Speed limiter
	Power Steering	N/A	
	SUSPENSIONS	Front Suspension	Double A-arm 9.75 in. (24.8 cm) travel
Front Shocks		Twin-tube	
Rear Suspension		Double A-arm 10.25 in. (26 cm) travel	
Rear Shocks		Twin-tube	
TIRES / WHEELS	Tires Wheels		6-ply rating 26 x 8/10 x 12 in. 12 in. steel
BRAKES	Front	Dual 214 mm disc brakes with hydraulic twin-piston calipers	
	Rear	Single 214 mm disc brake with hydraulic twin-piston caliper	
DIMENSIONS / CAPACITIES	Estimated Dry Weight*	800 lb (362.9 kg)	
	L x W x H	89.9 x 48.8 x 48.2 in. (228.4 x 123.9 x 122.5 cm)	
	Wheelbase	53 in. (134.5 cm)	
	Ground Clearance	13 in. (33 cm)	
	Seat Height	38.6 in. (98 cm)	
	Rack Capacity	Front: 120 lb (54.4 kg) / Rear: 240 lb (109 kg)	
	Storage Capacity	9 gal (34 L)	
	Towing Capacity	1,830 lb (830 kg)	
	Bed Capacity	N/A	
FEATURES	Fuel Capacity	5.1 gal (19.5 L)	
	Gauge	4.5 in. digital display	
	Magneto	420 W	
	Instrumentation	N/A	
	Ignition	RF Digitally Encoded Security System (D.E.S.S.™)	
	Lighting	LED headlights and taillights	
	Winch	N/A	
	Seat	Standard	
	Handlebar	Standard	
	Protection	Heavy-duty front bumper Rear bumper HMWPE front and rear A-arm protection (5 mm) Full skid plate	
	Hitch Type	2 in. hitch receiver	

† Visco-Lok is a trademark of GKN Visco-drive GmbH. All other trademarks are the property of their respective owners.

*Base model dry weight shown.

***1-year BRP limited warranty. B.E.S.T. term available up to 48 months.





	OUTLANDER PRO XU***		OUTLANDER PRO HUNTING EDITION***
COLOR OPTIONS	Desert Tan Compass Green		Dark Wildland Camo
ENGINES	Type	HD5 40 hp / 37 lb-ft, Rotax® ACE (Advanced Combustion Efficiency) 650 cc, single cylinder, liquid-cooled	HD7 50 hp / 41 lb-ft, Rotax® ACE (Advanced Combustion Efficiency) 650 cc, single cylinder, liquid-cooled
	Fuel Delivery System	Intelligent Throttle Control (ITC™) with Electronic Fuel Injection (EFI)	
	Transmission	pDrive™ primary CVT with work calibration Extra low L / H / N / R / P	
	Drive Train	Selectable 2WD / 4WD / Lock 4WD with Visco-4Lok [†] front differential	
	Driving Assistance	Intelligent Engine Braking (IEB™) Speed limiter	Work / Standard / Sport modes Intelligent Engine Braking (IEB™) Speed limiter
	Power Steering	Tri-Mode Dynamic Power Steering (DPS™)	
	SUSPENSIONS	Front Suspension	Double A-arm 9.75 in. (24.8 cm) travel
Front Shocks		Twin-tube	
Rear Suspension		Double A-arm 10.25 in. (26 cm) travel	
Rear Shocks		Twin-tube	
TIRES / WHEELS	XPS Trail King, 6-ply rating, 26 x 8/10 x 12 in. 12 in. cast aluminum		XPS Trail King, 6-ply rating, 26 x 8/10 x 12 in. 12 in. cast aluminum
BRAKES	Front	Dual 214 mm disc brakes with hydraulic twin-piston calipers	
	Rear	Single 214 mm disc brake with hydraulic twin-piston caliper	
DIMENSIONS / CAPACITIES	Estimated Dry Weight*	816 lb (370.1 kg)	828 lb (375.6 kg)
	L x W x H	89.9 x 48.8 x 48.2 in. (228.4 x 123.9 x 122.5 cm)	
	Wheelbase	53 in. (134.5 cm)	
	Ground Clearance	13 in. (33 cm)	
	Seat Height	38.6 in. (98 cm)	
	Rack Capacity	Front: 120 lb (54.4 kg) / Rear: 240 lb (109 kg)	
	Storage Capacity	9 gal (34 L)	
	Towing Capacity	1,830 lb (830 kg)	
	Bed Capacity	N/A	
FEATURES	Fuel Capacity	5.1 gal (19.5 L)	
	Gauge	4.5 in. digital display	
	Magneto	500 W	
	Instrumentation	Phone charger with 1 x USB-A and 1 x USB-C outputs	
	Ignition	RF Digitally Encoded Security System (D.E.S.S.™)	
	Lighting	LED headlights and taillights	
	Winch	N/A	
	Seat	Standard	
	Handlebar	Standard	
	Protection	Heavy-duty front bumper Rear bumper HMWPE front and rear A-arm protection (5 mm) Full skid plate	
	Hitch Type	2 in. hitch receiver	

† Visco-Lok is a trademark of GKN Viscodrive GmbH. All other trademarks are the property of their respective owners.

*Base model dry weight shown.



***1-year BRP limited warranty, B.E.S.T. term available up to 48 months.

			
		OUTLANDER MAX PRO XU***	OUTLANDER MAX PRO HUNTING EDITION***
COLOR OPTIONS		Desert Tan Compass Green	Dark Wildland Camo
ENGINES	Type	HD7 50 hp / 41 lb-ft, Rotax® ACE (Advanced Combustion Efficiency) 650 cc, single cylinder, liquid-cooled	HD7 50 hp / 41 lb-ft, Rotax® ACE (Advanced Combustion Efficiency) 650 cc, single cylinder, liquid-cooled
	Fuel Delivery System	Intelligent Throttle Control (ITC™) with Electronic Fuel Injection (EFI)	Intelligent Throttle Control (ITC™) with Electronic Fuel Injection (EFI)
	Transmission	pDrive™ primary CVT with work calibration Extra low L / H / N / R / P	pDrive™ primary CVT with work calibration Extra low L / H / N / R / P
	Drive Train	Selectable 2WD / 4WD / Lock 4WD with Visco-4Lok† front differential	Selectable 2WD / 4WD / Lock 4WD with Visco-4Lok† front differential
	Driving Assistance	Work / Standard / Sport modes Intelligent Engine Braking (IEB™) Speed limiter	Work / Standard / Sport modes Intelligent Engine Braking (IEB™) Speed limiter
	Power Steering	Tri-Mode Dynamic Power Steering (DPS™)	Tri-Mode Dynamic Power Steering (DPS™)
SUSPENSIONS	Front Suspension	Double A-arm 9.75 in. (24.8 cm) travel	Double A-arm 9.75 in. (24.8 cm) travel
	Front Shocks	Twin-tube	Twin-tube
	Rear Suspension	Double A-arm 10.25 in. (26 cm) travel	Double A-arm 10.25 in. (26 cm) travel
	Rear Shocks	Twin-tube	Twin-tube
TIRES / WHEELS	XPS Trail King, 6-ply rating, 26 x 8/10 x 12 in. 12 in. cast aluminum	XPS Trail King, 6-ply rating, 26 x 8/10 x 12 in. 12 in. cast aluminum	
BRAKES	Front	Dual 214 mm disc brakes with hydraulic twin-piston calipers	Dual 214 mm disc brakes with hydraulic twin-piston calipers
	Rear	Single 214 mm disc brake with hydraulic twin-piston caliper	Single 214 mm disc brake with hydraulic twin-piston caliper
DIMENSIONS / CAPACITIES	Estimated Dry Weight*	851 lb (386 kg)	863 lb (391.5 kg)
	L x W x H	94.2 x 47.6 x 54 in. (239.2 x 120.9 x 137.1 cm)	94.2 x 47.6 x 54 in. (239.2 x 120.9 x 137.1 cm)
	Wheelbase	60.4 in. (153.5 cm)	60.4 in. (153.5 cm)
	Ground Clearance	13 in. (33 cm)	13 in. (33 cm)
	Seat Height	38.6 in. (98 cm)	38.6 in. (98 cm)
	Rack Capacity	Front: 120 lb (54.4 kg) / Rear: 240 lb (109 kg)	Front: 120 lb (54.4 kg) / Rear: 240 lb (109 kg)
	Storage Capacity	9 gal (34 L)	9 gal (34 L)
	Towing Capacity	1,830 lb (830 kg)	1,830 lb (830 kg)
	Bed Capacity	N/A	N/A
Fuel Capacity	5.1 gal (19.5 L)	5.1 gal (19.5 L)	
FEATURES	Gauge	4.5 in. digital display	4.5 in. digital display
	Magneto	500 W	500 W
	Instrumentation	Phone charger with 1 x USB-A and 1 x USB-C outputs	Phone charger with 1 x USB-A and 1 x USB-C outputs
	Ignition	RF Digitally Encoded Security System (D.E.S.S.™)	RF Digitally Encoded Security System (D.E.S.S.™)
	Lighting	LED headlights and taillights	LED headlights and taillights
	Winch	N/A	Can-Am HD3500 (1,588 kg) winch with synthetic cable
	Seat	Removable passenger's seat	Removable passenger's seat
	Handlebar	Standard	Standard
	Protection	Heavy-duty front bumper Rear bumper HMWPE front and rear A-arm protection (5 mm) Full skid plate	Heavy-duty front bumper Rear bumper Full skid plate HMWPE footwell skid plate HMWPE front and rear A-arm protection (5 mm)
	Hitch Type	2 in. hitch receiver	2 in. hitch receiver

† Visco-Lok is a trademark of GKN Viscodrive GmbH. All other trademarks are the property of their respective owners.

*Base model dry weight shown.





***1-year BRP limited warranty. B.E.S.T. term available up to 48 months.

				
		OUTLANDER 2WD***	OUTLANDER***	
COLOR OPTIONS		Legion Red	Granite Grey Legion Red	
ENGINES	Type	500 40 hp / 37 lb-ft, Rotax® ACE (Advanced Combustion Efficiency) 650 cc, single-cylinder, liquid-cooled	500 40 hp / 37 lb-ft, Rotax® ACE (Advanced Combustion Efficiency) 650 cc, single-cylinder, liquid-cooled	700 50 hp / 41 lb-ft, Rotax® ACE (Advanced Combustion Efficiency) 650 cc, single-cylinder, liquid-cooled
	Fuel Delivery System	Electronic Fuel Injection (EFI)		
	Transmission	pDrive™ primary CVT L / H / N / R / P	pDrive™ primary CVT L / H / N / R / P	
	Drive Train	2WD system Selectable 2WD / 4WD with Visco-Lok [†] auto-locking front differential		
	Driving Assistance	N/A		
	Power Steering	N/A		
	SUSPENSIONS	Front Suspension	Double A-arm 9.75 in. (24.8 cm) travel	
Front Shocks		Twin-tube		
Rear Suspension		Double A-arm 10.25 in. (26 cm) travel		
Rear Shocks		Twin-tube		
TIRES / WHEELS	Tires	25 x 8/10 x 12 in. 12 in. steel		
	Wheels	25 x 8/10 x 12 in. 12 in. steel		
BRAKES	Front	Dual 214 mm disc brakes with hydraulic twin-piston calipers		
	Rear	Single 214 mm disc brake with hydraulic twin-piston caliper		
DIMENSIONS / CAPACITIES	Estimated Dry Weight*	718 lb (325.7 kg)		740 lb (335.7 kg)
	L x W x H	86.7 x 47.6 x 48 in. (220.2 x 120.9 x 122 cm)		
	Wheelbase	53 in. (134.5 cm)		53 in. (134.5 cm)
	Ground Clearance	12 in. (30.5 cm)		
	Seat Height	38 in. (96.7 cm)		
	Rack Capacity	Front: 120 lb (54.4 kg) / Rear: 240 lb (109 kg)		
	Storage Capacity	9 gal (34 L)		
	Towing Capacity	1,830 lb (830 kg)		
	Bed Capacity	N/A		
	Fuel Capacity	5.1 gal (19.5 L)		
FEATURES	Gauge	4.5 in. digital display		
	Magneto	420 W		
	Instrumentation	N/A		
	Ignition	Mechanical key		
	Lighting	LED headlights and taillights		
	Winch	N/A		
	Seat	Standard		
	Handlebar	Standard		
	Protection	Full skid plate		
	Hitch Type	2 in. hitch receiver		

† Visco-Lok is a trademark of GKN Viscodrives GmbH. All other trademarks are the property of their respective owners.

*Base model dry weight shown.

***1-year BRP limited warranty, B.E.S.T. term available up to 48 months.

					
		OUTLANDER DPS***		OUTLANDER XT***	OUTLANDER X MR***
COLOR OPTIONS		Legion Red Granite Grey Dark Wildland Camo		Platinum Satin Scandi Blue	Dark Wildland Camo Granite Grey
ENGINES	Type	500 40 hp / 37 lb-ft, Rotax® ACE (Advanced Combustion Efficiency) 650 cc, single-cylinder, liquid-cooled	700 50 hp / 41 lb-ft, Rotax® ACE (Advanced Combustion Efficiency) 650 cc, single-cylinder, liquid-cooled	700 50 hp / 41 lb-ft, Rotax® ACE (Advanced Combustion Efficiency) 650 cc, single-cylinder, liquid-cooled	700 50 hp / 41 lb-ft, Rotax® ACE (Advanced Combustion Efficiency) 650 cc, single-cylinder, liquid-cooled with strategically positioned engine air intake
	Fuel Delivery System	Electronic Fuel Injection (EFI)		Intelligent Throttle Control (iTC™) with Electronic Fuel Injection (EFI)	Intelligent Throttle Control (iTC™) with Electronic Fuel Injection (EFI)
	Transmission	pDrive™ primary CVT L / H / N / R / P		pDrive™ primary CVT L / H / N / R / P	pDrive™ primary CVT with strategically positioned air intake and exhaust Extra low L / H / N / R / P
	Drive Train	Selectable 2WD / 4WD with Visco-Lok [†] QE auto-locking front differential		Selectable 2WD / 4WD with Visco-Lok [†] QE auto-locking front differential	Selectable 2WD / 4WD / Lock 4WD with Visco-4Lok [†] front differential
	Driving Assistance	N/A	Work / Standard / Sport modes	Work / Standard / Sport modes Intelligent Engine Braking (iEB™)	Work / Standard / Sport modes Intelligent Engine Braking (iEB™)
	Power Steering	Tri-Mode Dynamic Power Steering (DPS™)		Tri-Mode Dynamic Power Steering (DPS™)	Tri-Mode Dynamic Power Steering (DPS™)
	SUSPENSIONS	Front Suspension	Double A-arm 9.75 in. (24.8 cm) travel		Double A-arm 9.75 in. (24.8 cm) travel
Front Shocks		Twin-tube		Twin-tube	Twin-tube
Rear Suspension		Double A-arm 10.25 in. (26 cm) travel		Double A-arm 10.25 in. (26 cm) travel	Double A-arm 9.75 in. (24.8 cm) travel
Rear Shocks		Twin-tube		Twin-tube	Twin-tube
TIRES / WHEELS	Tires	25 x 8/10 x 12 in. 12 in. steel		XPS Trail Force 26 x 8/10 x 14 in. 14 in. aluminum	XPS Swamp King 28 x 8/10 x 14 in. 14 in. aluminum
	Wheels				
BRAKES	Front	Dual 214 mm disc brakes with hydraulic twin-piston calipers		Dual 214 mm disc brakes with hydraulic twin-piston calipers	Dual 214 mm disc brakes with hydraulic twin-piston calipers
	Rear	Single 214 mm disc brake with hydraulic twin-piston caliper		Single 214 mm disc brake with hydraulic twin-piston caliper	Single 214 mm disc brake with hydraulic twin-piston caliper
DIMENSIONS / CAPACITIES	Estimated Dry Weight*	750 lb (340.2 kg)		858 lb (389.2 kg)	876 lb (397.3 kg)
	L x W x H	86.7 x 47.6 x 48 in. (220.2 x 120.9 x 122 cm)		89.9 x 48.8 x 48.2 in. (228.4 x 123.9 x 122.5 cm)	89.9 x 48.8 x 48.2 in. (228.4 x 123.9 x 122.5 cm)
	Wheelbase	53 in. (134.5 cm)		53 in. (134.5 cm)	53 in. (134.5 cm)
	Ground Clearance	12 in. (30.5 cm)		12.5 in. (31.8 cm)	13 in. (33 cm)
	Seat Height	38 in. (96.7 cm)		38.6 in. (98 cm)	38.6 in. (98 cm)
	Rack Capacity	Front: 120 lb (54.4 kg) / Rear: 240 lb (109 kg)		Front: 120 lb (54.4 kg) / Rear: 240 lb (109 kg)	Front: NA / Rear: 240 lb (109 kg)
	Storage Capacity	9 gal (34 L)		9 gal (34 L)	1 gal (3.8 L)
	Towing Capacity	1,830 lb (830 kg)		1,830 lb (830 kg)	1,830 lb (830 kg)
	Bed Capacity	N/A		N/A	N/A
	Fuel Capacity	5.1 gal (19.5 L)		5.1 gal (19.5 L)	5.1 gal (19.5 L)
FEATURES	Gauge	4.5 in. digital display		4.5 in. digital display	4.5 in. digital display
	Magneto	500 W		500 W	500 W
	Instrumentation	N/A		Phone charger with 1 x USB-A and 1 x USB-C outputs	Phone charger with 1 x USB-A and 1 x USB-C outputs
	Ignition	Mechanical key		RF Digitally Encoded Security System (D.E.S.S.™)	RF Digitally Encoded Security System (D.E.S.S.™) with tether
	Lighting	LED headlights and taillights		LED headlights and taillights	LED headlights and taillights
	Winch	N/A		Can-Am HD3500 (1,588 kg) winch with synthetic cable	N/A
	Seat	Standard		Standard	Standard
	Handlebar	Standard		Standard	Standard
	Protection	Full skid plate		Front and rear bumpers Full skid plate	Front bumper X mr footpegs Full skid plate
	Hitch Type	2 in. hitch receiver		2 in. hitch receiver	2 in. hitch receiver

†Visco-Lok is a trademark of GKN Viscodrive GmbH. All other trademarks are the property of their respective owners.

*Base model dry weight shown.

***1-year BRP limited warranty. B.E.S.T. term available up to 48 months.



		OUTLANDER MAX DPS***		OUTLANDER MAX XT***
COLOR OPTIONS		Legion Red Granite Grey		Platinum Satin Scandi Blue
		500	700	700
ENGINES	Type	40 hp / 37 lb-ft, Rotax® ACE (Advanced Combustion Efficiency) 650 cc, single-cylinder, liquid-cooled	50 hp / 41 lb-ft, Rotax® ACE (Advanced Combustion Efficiency) 650 cc, single-cylinder, liquid-cooled	50 hp / 41 lb-ft, Rotax® ACE (Advanced Combustion Efficiency) 650 cc, single-cylinder, liquid-cooled
	Fuel Delivery System	Electronic Fuel Injection (EFI)		Electronic Fuel Injection (EFI)
	Transmission	pDrive™ primary CVT L / H / N / R / P		pDrive™ primary CVT L / H / N / R / P
	Drive Train	Selectable 2WD / 4WD with Visco-Lok† QE auto-locking front differential		Selectable 2WD / 4WD with Visco-Lok† QE auto-locking front differential
	Driving Assistance	N/A	Work / Standard / Sport modes	Work / Standard / Sport modes Intelligent Engine Braking (IEB™)
	Power Steering	Tri-Mode Dynamic Power Steering (DPS™)		Tri-Mode Dynamic Power Steering (DPS™)
SUSPENSIONS	Front Suspension	Double A-arm 9.75 in. (24.8 cm) travel		Double A-arm 9.75 in. (24.8 cm) travel
	Front Shocks	Twin-tube		Twin-tube
	Rear Suspension	Double A-arm 10.25 in. (26 cm) travel		Double A-arm 10.25 in. (26 cm) travel
	Rear Shocks	Twin-tube		Twin-tube
TIRES / WHEELS	25 x 8/10 x 12 in. 12 in. steel		XPS Trail Force 26 x 8/10 x 14 in. 14 in. aluminum	
BRAKES	Front	Dual 214 mm disc brakes with hydraulic twin-piston calipers		Dual 214 mm disc brakes with hydraulic twin-piston calipers
	Rear	Single 214 mm disc brake with hydraulic twin-piston caliper		Single 214 mm disc brake with hydraulic twin-piston caliper
DIMENSIONS / CAPACITIES	Estimated Dry Weight*	785 lb (356.1 kg)		893 lb (405.1 kg)
	L x W x H	94.2 x 47.6 x 54 in. (239.2 x 120.9 x 137.1 cm)		94.2 x 47.6 x 54 in. (239.2 x 120.9 x 137.1 cm)
	Wheelbase	60.4 in. (153.5 cm)		60.4 in. (153.5 cm)
	Ground Clearance	12 in. (30.5 cm)		12.5 in. (31.8 cm)
	Seat Height	38.6 in. (98 cm)		38.6 in. (98 cm)
	Rack Capacity	Front: 120 lb (54.4 kg) / Rear: 240 lb (109 kg)		Front: 120 lb (54.4 kg) / Rear: 240 lb (109 kg)
	Storage Capacity	9 gal (34 L)		9 gal (34 L)
	Towing Capacity	1,830 lb (830 kg)		1,830 lb (830 kg)
	Bed Capacity	N/A		N/A
Fuel Capacity	5.1 gal (19.5 L)		5.1 gal (19.5 L)	
FEATURES	Gauge	4.5 in. digital display		4.5 in. digital display
	Magneto	500 W		500 W
	Instrumentation	N/A		Phone charger with 1 x USB-A and 1 x USB-C outputs
	Ignition	Mechanical key		RF Digitally Encoded Security System (D.E.S.S.™)
	Lighting	LED headlights and taillights		LED headlights and taillights
	Winch	N/A		Can-Am HD3500 (1,588 kg) winch with synthetic cable
	Seat	Standard		Standard
	Handlebar	Standard		Standard
	Protection	Full skid plate		Front and rear bumpers Full skid plate
	Hitch Type	2 in. hitch receiver		2 in. hitch receiver

† Visco-Lok is a trademark of GKN Viscodrive GmbH. All other trademarks are the property of their respective owners.

*Base model dry weight shown.

***1-year BRP limited warranty, B.E.S.T. term available up to 48 months.



		OUTLANDER DPS***		OUTLANDER BACKCOUNTRY***
COLOR OPTIONS		Granite Grey		Stealth Black Multicam Dark Camo
ENGINES	Type	850	1000R	1000R
		82 hp / 66 lb-ft, Rotax® 999 cc V-twin, DOHC, liquid-cooled Radiator cooling fan of 80 W & 150 cm²		101 hp / 69 lb-ft, Rotax® 999 cc V-twin, DOHC, liquid-cooled High flow radiator cooling fan of 120 W & 500 cm²
	Fuel Delivery System	Intelligent Throttle Control (ITC™) with Electronic Fuel Injection (EFI)		
	Transmission	pDrive primary CVT L / H / N / R / P	pDrive™ primary CVT with specific calibration L / H / N / R / P	
	Drive Train	Selectable 2WD / 4WD with Visco-Lok† QE auto-locking front differential		
	Driving Assistance	Work / Standard / Sport modes Intelligent Engine Braking (IEB™)		
	Power Steering	Tri-Mode Dynamic Power Steering (DPS™)		
SUSPENSIONS	Front Suspension	Arched double A-arm 10.8 in. (27.4 cm) travel		Arched double A-arm with sway bar 7.5 in. (19 cm) travel
	Front Shocks	Twin-tube		SHOWA Internal Floating Piston (IFP) Shocks
	Rear Suspension	Arched double A-arm 12 in. (30.5 cm) travel		Arched double A-arm 10.2 in. (25.9 cm) travel
	Rear Shocks	Twin-tube		SHOWA Internal Floating Piston (IFP) Shocks
TIRES / WHEELS	Tires	26 x 8/10 x 12 in. 12 in. aluminum		XPS Iron Force – 30 x 9 x 14 in. 14 in. aluminum beadlock
	Wheels	26 x 8/10 x 12 in. 12 in. aluminum		26 x 8/10 x 14 in. 14 in. aluminum
BRAKES	Front	Dual 214 mm disc brakes with hydraulic twin-piston calipers		
	Rear	Single 214 mm disc brake with hydraulic twin-piston caliper	Dual 214 mm disc brakes with hydraulic twin-piston calipers	
DIMENSIONS / CAPACITIES	Estimated Dry Weight*	942 lb (427 kg)		1,029 lb (467 kg)
	L x W x H	84 x 48.5 x 49 in. (213.4 x 123.1 x 124.5 cm)		88.4 x 49.6 x 54.2 in. (224.5 x 126 x 137.7 cm)
	Wheelbase	52.8 in. (134.2 cm)		52.8 in. (134.2 cm)
	Ground Clearance	11.5 in. (29.2 cm)		13 in. (33 cm)
	Seat Height	37.8 in. (96 cm)		38.6 in. (98 cm)
	Rack Capacity	Front: 120 lb (54.4 kg) / Rear: 240 lb (109 kg)		Front: 120 lb (54.4 kg) / Rear: 240 lb (109 kg)
	Storage Capacity	10.6 gal (40 L)		10.6 gal (40 L)
	Towing Capacity	1,830 lb (830 kg)		1,830 lb (830 kg)
	Bed Capacity	N/A		N/A
	Fuel Capacity	5.1 gal (19.5 L)		5.1 gal (19.5 L)
FEATURES	Gauge	7.6 in. wide digital display		7.6 in. wide digital display
	Magneto	650 W		650 W
	Instrumentation	Phone storage		Phone storage & USB-C charger
	Ignition	RF Digitally Encoded Security System (D.E.S.S.™)		
	Lighting	LED headlights and taillights	LED headlights and taillights LED signature	
	Winch	N/A		Can-Am HD3500 (1,588 kg) winch with synthetic cable
	Seat	Standard		Standard
	Handlebar	Standard		Aluminum U type 57 mm
	Protection	Full skid plate		Heavy-duty front and rear bumpers Full skid plate and footwell Front and rear A-arm protection (5 mm) Handguards
	Hitch Type	2 in. hitch receiver		2 in. hitch receiver

† Visco-Lok is a trademark of GKN Visco-drive GmbH. All other trademarks are the property of their respective owners.

*Base model dry weight shown.

***1-year BRP limited warranty. B.E.S.T. term available up to 48 months.



		OUTLANDER XT***		OUTLANDER XT-P***
COLOR OPTIONS		Platinum Satin Dark Wildland Camo Fiery Red		Mineral Grey & Orange Crush
ENGINES	Type	850	1000R	1000R
	Fuel Delivery System	Intelligent Throttle Control (ITC™) with Electronic Fuel Injection (EFI)		Intelligent Throttle Control (ITC™) with Electronic Fuel Injection (EFI)
	Transmission	pDrive™ primary CVT L / H / N / R / P	pDrive™ primary CVT with specific calibration L / H / N / R / P	pDrive™ primary CVT with specific calibration L / H / N / R / P
	Drive Train	Selectable 2WD / 4WD with Visco-Lok® QE auto-locking front differential	Selectable 2WD / 4WD / Lock 4WD with Visco-4Lok® front differential	Selectable 2WD / 4WD / Lock 4WD with Visco-4Lok® front differential
	Driving Assistance	Work / Standard / Sport modes Intelligent Engine Braking (IEB™)		Work / Standard / Sport modes Intelligent Engine Braking (IEB™)
	Power Steering	Tri-Mode Dynamic Power Steering (DPS™)		Tri-Mode Dynamic Power Steering (DPS™)
	SUSPENSIONS	Front Suspension	Arched double A-arm 10.8 in. (27.4 cm) travel	Arched double A-arm with sway bar 10.8 in. (27.4 cm) travel
Front Shocks		Twin-tube		Piggyback FOX Podium QS3® gas shocks OR KYB shocks with Smart-Shox™ technology
Rear Suspension		Arched double A-arm 12 in. (30.5 cm) travel		Arched double A-arm 12 in. (30.5 cm) travel
Rear Shocks		Twin-tube		Piggyback FOX Podium QS3® gas shocks OR KYB shocks with Smart-Shox™ technology
TIRES / WHEELS	Tires	XPS Trail King 2 – 26 x 8/10 x 14 14 in. aluminum		XPS Trail King 2 – 27 x 8/10 x 14 in. 14 in. aluminum beadlock
	Wheels			
BRAKES	Front	Dual 214 mm disc brakes with hydraulic twin-piston calipers		OVERSIZED dual 252 mm disc brakes with hydraulic twin-piston calipers
	Rear	Single 214 mm disc brake with hydraulic twin-piston caliper	Dual 214 mm disc brakes with hydraulic twin-piston calipers	Dual 214 mm disc brakes with hydraulic twin-piston calipers
DIMENSIONS / CAPACITIES	Estimated Dry Weight*	975 lb (442 kg)		975 lb (442 kg)
	L x W x H	88.4 x 48.5 x 49 in. (224.6 x 123.1 x 124.5 cm)		88.4 x 48.5 x 49 in. (224.6 x 123.1 x 124.5 cm)
	Wheelbase	52.8 in. (134.2 cm)		52.8 in. (134.2 cm)
	Ground Clearance	11.5 in. (29.2 cm)		12 in. (30.5 cm)
	Seat Height	37.8 in. (96 cm)		37.8 in. (96 cm)
	Rack Capacity	Front: 120 lb (54.4 kg) / Rear: 240 lb (109 kg)		Front: 120 lb (54.4 kg) / Rear: 240 lb (109 kg)
	Storage Capacity	10.6 gal (40 L)		10.6 gal (40 L)
	Towing Capacity	1,830 lb (830 kg)		1,830 lb (830 kg)
	Bed Capacity	N/A		N/A
	Fuel Capacity	5.1 gal (19.5 L)		5.1 gal (19.5 L)
FEATURES	Gauge	7.6 in. wide digital display		7.6 in. wide digital display OR 10.25 in. touchscreen display
	Magneto	650 W		650 W
	Instrumentation	Phone storage & USB-C charger		Phone storage & USB charger
	Ignition	RF Digitally Encoded Security System (D.E.S.S.™)		RF Digitally Encoded Security System (D.E.S.S.™)
	Lighting	LED headlights and taillights	LED headlights and taillights LED signature	LED headlights and taillights LED signature
	Winch	Can-Am HD3500 (1,588 kg) winch with synthetic cable		Can-Am HD3500 (1,588 kg) winch with synthetic cable
	Seat	Standard		Special Edition seat (color, stitching and material)
	Handlebar	Standard		Aluminum taper-profile handlebar with sport handguards
	Protection	Full skid plate • Heavy-duty front and rear bumpers • Handguards		Full skid plate Heavy-duty front and rear bumpers Handguards
	Hitch Type	2 in. hitch receiver		2 in. hitch receiver

† Visco-Lok is a trademark of GKN Viscodrive GmbH. All other trademarks are the property of their respective owners.

* Base model dry weight shown.

*** 1-year BRP limited warranty, B.E.S.T. term available up to 48 months.



OUTLANDER X MR***

COLOR OPTIONS		Granite Grey 850 / 1000R Loft Green Satin 1000R	
ENGINES	Type	850 82 hp / 66 lb-ft, Rotax® 999 cc V-twin, DOHC, liquid-cooled with strategically positioned engine air intake High flow radiator cooling fan of 120 W & 500 cm ³	1000R 101 hp / 69 lb-ft, Rotax® 999 cc V-twin, DOHC, liquid-cooled with strategically positioned engine air intake High flow radiator cooling fan of 120 W & 500 cm ³
	Fuel Delivery System	Intelligent Throttle Control (ITC™) with Electronic Fuel Injection (EFI)	
	Transmission	pDrive™ primary CVT with strategically positioned air intake and exhaust Extra low L / H / N / R / P	pDrive™ primary CVT with strategically positioned air intake and exhaust & specific calibration Extra low L / H / N / R / P
	Drive Train	Selectable 2WD / 4WD / Lock 4WD with Visco-4Lok [†] front differential	
	Driving Assistance	Work / Standard / Sport modes Intelligent Engine Braking (IEB™)	
	Power Steering	Tri-Mode Dynamic Power Steering (DPS™)	
SUSPENSIONS	Front Suspension	Arched double A-arm 7.5 in. (19 cm) travel	
	Front Shocks	SHOWA Internal Floating Piston (IFP) Shocks	
	Rear Suspension	Arched double A-arm 10.2 in. (25.9 cm) travel	
	Rear Shocks	SHOWA Internal Floating Piston (IFP) Shocks	
TIRES / WHEELS	Tires	XPS Swamp King XL 30 in.	
	Wheels	14 in. aluminum	
BRAKES	Front	Dual 214 mm disc brakes with hydraulic twin-piston calipers	
	Rear	Dual 214 mm disc brakes with hydraulic twin-piston calipers	
DIMENSIONS / CAPACITIES	Estimated Dry Weight*	1,046 lb (474 kg)	
	L x W x H	95.6 x 49.7 x 54.2 in. (242.9 x 126.2 x 137.6 cm)	
	Wheelbase	52.8 in. (134.2 cm)	
	Ground Clearance	13.2 in. (33.5 cm)	
	Seat Height	37.8 in. (96 cm)	
	Rack Capacity	Front: NA / Rear: 240 lb (109 kg)	
	Storage Capacity	1 gal (3.8 L)	
	Towing Capacity	1,830 lb (830 kg)	
	Bed Capacity	N/A	
	Fuel Capacity	5.1 gal (19.5 L)	
FEATURES	Gauge	7.6 in. wide digital display	
	Magneto	650 W	
	Instrumentation	Phone storage & USB-C charger	
	Ignition	RF Digitally Encoded Security System (D.E.S.S.™) with tether	
	Lighting	LED headlights and taillights	LED headlights and taillights LED signature
	Winch	3,500 lb (1,588 kg) bumper mounted winch with synthetic cable	
	Seat	Special Edition seat (color, stitching and material)	
	Handlebar	Standard	Aluminum tapered-profile handlebar with J-hook, mud handgrip, mud strap and 1 in. riser
	Protection	Full skid plate MUD front bumper with winch mount Heavy-duty rear bumper Aluminum pegs (driver footrest)	
	Hitch Type	2 in. hitch receiver	

† Visco-Lok is a trademark of GKN Viscodrive GmbH. All other trademarks are the property of their respective owners.

*Base model dry weight shown.

***1-year BRP limited warranty. B.E.S.T. term available up to 48 months.





	OUTLANDER MAX DPS***		OUTLANDER MAX BACKCOUNTRY***
COLOR OPTIONS	Granite Grey		Stealth Black Multicam Dark Camo
ENGINES	Type	850 82 hp / 66 lb-ft, Rotax® 999 cc V-twin, DOHC, liquid-cooled Radiator cooling fan of 80 W & 150 cm ³	1000R 101 hp / 69 lb-ft, Rotax® 999 cc V-twin, DOHC, liquid-cooled High flow radiator cooling fan of 120 W & 500 cm ³
	Fuel Delivery System	Intelligent Throttle Control (iTC™) with Electronic Fuel Injection (EFI)	
	Transmission	pDrive™ primary CVT L / H / N / R / P	pDrive™ primary CVT with specific calibration L / H / N / R / P
	Drive Train	Selectable 2WD / 4WD with Visco-Lok™ QE auto-locking front differential	
	Driving Assistance	Work / Standard / Sport modes Intelligent Engine Braking (IEB™)	
	Power Steering	Tri-Mode Dynamic Power Steering (DPS™)	
	SUSPENSIONS	Front Suspension	Arched double A-arm 10.8 in. (27.4 cm) travel
Front Shocks		Twin-tube	
Rear Suspension		Arched double A-arm 12 in. (30.5 cm) travel	
Rear Shocks		Twin-tube	
TIRES / WHEELS	Tires	26 x 8/10 x 12 in. 12 in. aluminum	26 x 8/10 x 14 in. 14 in. aluminum
	Wheels	XPS Iron Force – 30 x 9 x 14 in. 14 in. aluminum beadlock	
BRAKES	Front	Dual 214 mm disc brakes with hydraulic twin-piston calipers	
	Rear	Single 214 mm disc brake with hydraulic twin-piston caliper	Dual 214 mm disc brakes with hydraulic twin-piston calipers
DIMENSIONS / CAPACITIES	Estimated Dry Weight*	967 lb (439 kg)	
	L x W x H	94.8 x 48.5 x 56.4 in. (240.8 x 123.2 x 143.2 cm)	
	Wheelbase	60.8 in. (154.4 cm)	
	Ground Clearance	11.5 in. (29.2 cm)	
	Seat Height	37.8 in. (96 cm)	
	Rack Capacity	Front: 120 lb (54.4 kg) / Rear: 240 lb (109 kg)	
	Storage Capacity	10.6 gal (40 L)	
	Towing Capacity	1,830 lb (830 kg)	
	Bed Capacity	N/A	
Fuel Capacity	5.1 gal (19.5 L)		
FEATURES	Gauge	7.6 in. wide digital display	
	Magneto	650 W	
	Instrumentation	Phone storage	
	Ignition	RF Digitally Encoded Security System (D.E.S.S.™)	
	Lighting	LED headlights and taillights	LED headlights and taillights LED signature
	Winch	N/A	
	Seat	Removable passenger's seat	
	Handlebar	Standard	
	Protection	Full skid plate	
	Hitch Type	2 in. hitch receiver	

† Visco-Lok is a trademark of GKN Viscodrive GmbH. All other trademarks are the property of their respective owners.

* Base model dry weight shown.



*** 1-year BRP limited warranty. B.E.S.T. term available up to 48 months.

					
	OUTLANDER MAX XT***		OUTLANDER MAX XT-P***	OUTLANDER MAX LIMITED***	
COLOR OPTIONS	Platinum Satin Dark Wildland Camo Fiery Red		Mineral Grey & Orange Crush	Dusty Navy	
ENGINES	Type	850 82 hp / 66 lb-ft, Rotax® 999 cc V-twin, DOHC, liquid-cooled, Radiator cooling fan of 80 W & 150 cm ²	1000R 101 hp / 69 lb-ft, Rotax® 999 cc V-twin, DOHC, liquid-cooled, High flow radiator cooling fan of 120 W & 500 cm ²	1000R 101 hp / 69 lb-ft, Rotax® 999 cc V-twin, DOHC, liquid-cooled, High flow radiator cooling fan of 120 W & 500 cm ²	
	Fuel Delivery System	Intelligent Throttle Control (ITC™) with Electronic Fuel Injection (EFI)		Intelligent Throttle Control (ITC™) with Electronic Fuel Injection (EFI)	
	Transmission	pDrive™ primary CVT L / H / N / R / P	pDrive™ primary CVT with specific calibration L / H / N / R / P	pDrive™ primary CVT with specific calibration L / H / N / R / P	pDrive™ primary CVT with specific calibration L / H / N / R / P
	Drive Train	Selectable 2WD / 4WD with Visco-Lok [†] QE auto-locking front differential	Selectable 2WD / 4WD / Lock 4WD with Visco-4Lok [†] front differential	Selectable 2WD / 4WD / Lock 4WD with Visco-4Lok [†] front differential	Selectable 2WD / 4WD / Lock 4WD with Visco-4Lok [†] front differential
	Driving Assistance	Work / Standard / Sport modes Intelligent Engine Braking (IEB™)		Work / Standard / Sport modes Intelligent Engine Braking (IEB™)	Work / Standard / Sport modes Intelligent Engine Braking (IEB™)
	Power Steering	Tri-Mode Dynamic Power Steering (DPS™)		Tri-Mode Dynamic Power Steering (DPS™)	Tri-Mode Dynamic Power Steering (DPS™)
SUSPENSIONS	Front Suspension	Arched double A-arm 10.8 in. (27.4 cm) travel	Arched double A-arm with sway bar 10.8 in. (27.4 cm) travel	Arched double A-arm with sway bar 10.8 in. (27.4 cm) travel	
	Front Shocks	Twin-tube		Piggyback FOX Podium QS3 [†] gas shocks OR KYB shocks with Smart-Shox™ technology	
	Rear Suspension	Arched double A-arm 12 in. (30.5 cm) travel		Arched double A-arm 12 in. (30.5 cm) travel	
	Rear Shocks	Twin-tube		Piggyback FOX Podium QS3 [†] gas shocks OR KYB shocks with Smart-Shox™ technology	
TIRES / WHEELS	XPS Trail King 2 – 26 x 8/10 x 14 in. 14 in. aluminum		XPS Trail King 2 – 27 x 8/10 x 14 in. 14 in. aluminum beadlock	XPS Trail King 2 – 27 x 8/10 x 14 in. 14 in. aluminum	
BRAKES	Front	Dual 214 mm disc brakes with hydraulic twin-piston calipers		OVERSIZED dual 252 mm disc brakes with hydraulic twin-piston calipers	
	Rear	Single 214 mm disc brake with hydraulic twin-piston caliper	Dual 214 mm disc brakes with hydraulic twin-piston calipers		
DIMENSIONS / CAPACITIES	Estimated Dry Weight*	998 lb (453 kg)		998 lb (453 kg)	
	L x W x H	99 x 48.5 x 56.4 in. (252 x 123.2 x 143.2 cm)		99 x 48.5 x 56.4 in. (252 x 123.2 x 143.2 cm)	
	Wheelbase	60.8 in. (154.4 cm)		60.8 in. (154.4 cm)	
	Ground Clearance	11.5 in. (29.2 cm)		12 in. (30.5 cm)	
	Seat Height	37.8 in. (96 cm)		37.8 in. (96 cm)	
	Rack Capacity	Front: 120 lb (54.4 kg) / Rear: 240 lb (109 kg)		Front: 120 lb (54.4 kg) / Rear: 240 lb (109 kg)	
	Storage Capacity	10.6 gal (40 L)		10.6 gal (40 L)	
	Towing Capacity	1,830 lb (830 kg)		1,830 lb (830 kg)	
	Bed Capacity	N/A		N/A	
Fuel Capacity	5.1 gal (19.5 L)		5.1 gal (19.5 L)		
FEATURES	Gauge	7.6 in. wide digital display		7.6 in. wide digital display OR 10.25 in. touchscreen display	
	Magneto	650 W		650 W	
	Instrumentation	Phone storage & USB-C charger		Phone storage & USB-C charger	
	Ignition	RF Digitally Encoded Security System (D.E.S.S.™)		RF Digitally Encoded Security System (D.E.S.S.™)	
	Lighting	LED headlights and taillights	LED headlights and taillights, LED signature	LED headlights and taillights, LED signature	
	Winch	Can-Am HD3500 (1,588 kg) winch with synthetic cable		Can-Am HD3500 (1,588 kg) winch with synthetic cable	
	Seat	Removable passenger's seat		Special Edition seat (color, stitching and material) with removable passenger's seat	
	Handlebar	Standard		Aluminum taper-profile handlebar with sport handguards	
	Protection	Full skid plate Heavy-duty front and rear bumpers Handguards		Full skid plate Heavy-duty front and rear bumpers Handguards	
	Hitch Type	2 in. hitch receiver		2 in. hitch receiver	

†Visco-Lok is a trademark of GKN ViscoDrive GmbH. All other trademarks are the property of their respective owners.

*Base model dry weight shown.

***1-year BRP limited warranty. B.E.S.T. term available up to 48 months.

				
	OUTLANDER MAX 6X6 DPS***	OUTLANDER MAX 6X6 DPS***	OUTLANDER MAX 6X6 BACKCOUNTRY***	
COLOR OPTIONS	Granite Grey	Granite Grey	Stealth Black	
ENGINES	Type	700 50 hp / 41 lb-ft, Rotax® ACE (Advanced Combustion Efficiency) 650 cc, single cylinder, liquid-cooled	850 82 hp / 66 lb-ft, Rotax® 999 cc V-twin, DOHC, liquid-cooled High flow radiator cooling fan of 120 W & 500 cm ³	1000R 101 hp / 69 lb-ft, Rotax® 999 cc V-twin, DOHC, liquid-cooled High flow radiator cooling fan of 120 W & 500 cm ³
	Fuel Delivery System	Intelligent Throttle Control (ITC™) with Electronic Fuel Injection (EFI)	Intelligent Throttle Control (ITC™) with Electronic Fuel Injection (EFI)	Intelligent Throttle Control (ITC™) with Electronic Fuel Injection (EFI)
	Transmission	pDrive™ primary CVT with work calibration Extra low L / H / N / R / P	pDrive™ primary CVT with work calibration Extra low L / H / N / R / P	pDrive™ primary CVT with work calibration Extra low L / H / N / R / P
	Drive Train	Selectable 4WD / 6WD with Visco-Lok [†] QE front differential	Selectable 4WD / 6WD with Visco-Lok [†] QE front differential	Selectable 4WD / 6WD / Lock 6WD with Visco-6LoK [†] front differential
	Driving Assistance	Work / Standard / Sport modes Intelligent Engine Braking (IEB™)	Work / Standard / Sport modes Intelligent Engine Braking (IEB™), speed limiter	Work / Standard / Sport modes Intelligent Engine Braking (IEB™), speed limiter
	Power Steering	Tri-Mode Dynamic Power Steering (DPS™)	Tri-Mode Dynamic Power Steering (DPS™)	Tri-Mode Dynamic Power Steering (DPS™)
	SUSPENSIONS	Front Suspension	Double A-arm 9.8 in. (24.8 cm) travel	Arched double A-arm 10 in. (25.2 cm) travel
Front Shocks		Oil shocks (REC calibration)	Oil shocks (REC calibration)	SHOWA Internal Floating Piston (IFP) Shocks
Rear Suspension		Double A-arm 9.7 in. (24.7 cm) travel	Arched double A-arm with sway bar on middle axle 9.8 in. (24.8 cm) travel	Arched double A-arm with sway bar on middle axle 9 in. (22.9 cm) travel
Rear Shocks		Oil shocks (REC calibration)	Oil shocks (REC calibration)	SHOWA Internal Floating Piston (IFP) Shocks
TIRES / WHEELS	XPS Trail King – 26 x 8/10 x 12 in. 12 in. steel	XPS Trail King – 28 x 8/10 x 14 in. 14 in. aluminum	XPS Iron Force – 30 x 9 x 14 in. 14 in. aluminum beadlock	
BRAKES	Front	Dual 214 mm disc brakes with hydraulic twin-piston calipers	OVERSIZED dual 252 mm disc brakes with hydraulic twin-piston calipers	OVERSIZED dual 252 mm disc brakes with hydraulic twin-piston calipers
	Rear	Dual 214 mm disc brakes with hydraulic twin-piston calipers	Dual 214 mm disc brakes with hydraulic twin-piston calipers	Dual 214 mm disc brakes with hydraulic twin-piston calipers
DIMENSIONS / CAPACITIES	Estimated Dry Weight*	1,227 lb (558 kg)	1,388 lb (631 kg)	1,449 lb (659 kg)
	L x W x H	123.7 x 48.8 x 54.2 in. (314.3 x 124 x 137.7 cm)	123.7 X 48.8 X 55.2 in. (314.3 x 124 x 140.2 cm)	126.9 X 50.2 X 56 in. (322.3 x 127.4 x 142.2 cm)
	Wheelbase	93.3 in (237 cm)	93.3 in (237 cm)	93.3 in (237 cm)
	Ground Clearance	12 in. (30.5 cm)	12 in. (30.5 cm)	13 in. (33 cm)
	Seat Height	36.8 in. (93.4 cm)	36.8 in. (93.4 cm)	37.8 in. (96 cm)
	Rack Capacity	Front: 120 lb (54.4 kg)	Front: 120 lb (54.4 kg)	Front: 120 lb (54.4 kg)
	Storage Capacity	Front cargo: 8 gal (30 L) Rear cargo: 58 gal (220 L) Total: 66 gal (250 L)	Front cargo: 8 gal (30 L) Rear cargo: 58 gal (220 L) Rear undercargo: 6.6 gal (25 L) Total: 72.6 gal (275 L)	Front cargo: 8 gal (30 L) Rear cargo: 58 gal (220 L) Rear undercargo: 6.6 gal (25 L) Total: 72.6 gal (275 L)
	Towing Capacity	1,830 lb (830 kg)	1,830 lb (830 kg)	1,830 lb (830 kg)
	Bed Capacity	1,000 lb (454 kg)	1,000 lb (454 kg)	1,000 lb (454 kg)
	Fuel Capacity	5.1 gal (19.5 L)	5.1 gal (19.5 L)	5.1 gal (19.5 L)
FEATURES	Gauge	4.5 in. digital display	7.6 in. wide digital display	7.6 in. wide digital display
	Magneto	500 W	650 W	650 W
	Instrumentation	Glove box	Phone storage	Phone storage & USB-C charger
	Ignition	RF Digitally Encoded Security System (D.E.S.S.™)	RF Digitally Encoded Security System (D.E.S.S.™)	RF Digitally Encoded Security System (D.E.S.S.™)
	Lighting	LED headlights and taillights	LED headlights and taillights	LED headlights and taillights, LED signature
	Winch	N/A	N/A	Can-Am HD3500 (1,588 kg) winch with synthetic cable
	Seat	Standard	Removable passenger's seat	Special Edition with removable passenger's seat
	Handlebar	Standard	Standard	Aluminum U type (57 mm)
	Protection	Full skid plate	Full skid plate	Heavy-duty front bumper • Full skid plate • Footwell protectors • Front & rear A-arms protectors • Handguards
	Hitch Type	2 in. hitch receiver	2 in. hitch receiver	2 in. hitch receiver

† Visco-Lok is a trademark of GKN Viscodrive GmbH. All other trademarks are the property of their respective owners.

*Base model dry weight shown.

***1-year BRP limited warranty, B.E.S.T. term available up to 48 months.



OUTLANDER ELECTRIC***



OUTLANDER MAX ELECTRIC***

COLOR OPTIONS		White Granite Grey	White Granite Grey
MOTOR	Type	Electric	
	Power	47 hp / 53 lb-ft, ROTAX® E-POWER, liquid-cooled	
	Torque Motor	Peak: 47 hp (35 kW) Continuous: 27 hp (20 kW)	
	Top Speed	Peak: 53 lb-ft (72 Nm) Continuous: 21 lb-ft (28Nm)	
	Battery Type	Integrated, lithium-ion	
BATTERY	Battery Operating Temperature Range	From -20°C to 40°C (-4 Fahrenheit to 104 Fahrenheit)	
	Battery Capacity	8.9 kWh	
	Cooling System	Liquid-cooled: battery, inverter and on-board charger Integrated AC heater for charging at low temperature	
	Estimated Range (when fully charged)	Tested in accordance with WMTTC*: 47 miles (75 km) Average utility range*: 31 miles (50 km)	
	Function	Regen braking with 3 levels of adjustment	
	Charger	On-board charger 6.6 kW Level 2 (compatible with Level 1 charging)	
	Connector Type	Type 1 J1772 with integrated LED light	
	Charging Time Level 2 (240 V)	50 min (20-80%) 1 hour 30 min (0-100%)	
	Charging Time Level 1 (120 V)	3 hours 10 min (20-80%) 5 hours 15 min (0-100%)	
	DRIVE TRAIN	Transmission	L / N / H / P Reverse activated via start button
Drive Train		Selectable 2WD / 4WD with Visco-Lok® QE auto-locking front differential	
Driving Assistance		Work / Standard / Sport modes Speed limiter	
Power Steering		Tri-Mode Dynamic Power Steering (DPS™)	
SUSPENSIONS	Front Suspension	Double A-arm 9.75 in. (24.8 cm) travel	
	Front Shocks	Twin-tube	
	Rear Suspension	Double A-arm 10.25 in. (26 cm) travel	
	Rear Shocks	Twin-tube	
TIRES / WHEELS	XPS Recon Force 26 x 8/10 x 14 in. 14 in. cast aluminum		
BRAKES	Front	Dual 214 mm disc brakes with hydraulic twin-piston calipers	
	Rear	Single 214 mm disc brake with hydraulic twin-piston caliper	
DIMENSIONS / CAPACITIES	Estimated Dry Weight*	875 lb (398 kg)	
	L x W x H	86.7 x 47.6 x 48 in. (220.2 x 120.9 x 122 cm)	
	Wheelbase	53 in. (134.5 cm)	
	Ground Clearance	12 in. (30.5 cm)	
	Seat Height	38 in. (96.7 cm)	
	Rack Capacity	Front: 120 lb (54.4 kg) / Rear: 240 lb (109 kg)	
	Storage Capacity	9 gal (34 L)	
	Towing Capacity	1,830 lb (830 kg)	
	Bed Capacity	N/A	
	Fuel Capacity	N/A	
FEATURES	Gauge	5 in. colored display	
	DC - DC converter	Continuous 500 W (at all speeds including at idle)	
	Instrumentation	Phone charger with 1 x USB-A and 1 x USB-C outputs	
	Ignition	RF Digitally Encoded Security System (D.E.S.S.™)	
	Lighting	LED headlights and taillights, LED signature, LED POD light	
	Winch	N/A	
	Seat	Standard	
	Handlebar	Standard	
	Protection	Front and rear bumpers Full skid plate	
	Hitch Type	2 in. hitch receiver	

† Visco-Lok is a trademark of GKN Viscodrive GmbH. All other trademarks are the property of their respective owners.

*Base model dry weight shown.





***Battery: 5 years (12,427 miles / 20,000 km limit). Motor: 1-year Vehicle: 1-year BRP limited warranty

				
	RENEGADE X XC***	RENEGADE X MR***	RENEGADE X MR***	
COLOR OPTIONS	Catalyst Grey	Catalyst Grey	Scandi Blue Hyper Silver & Legion Red	
ENGINES	Type	1000R 91 hp, Rotax® 976 cc V-twin, liquid-cooled	650 62 hp, Rotax® 650 cc V-twin, snorkeled, liquid-cooled	1000R 91 hp, Rotax® 976 cc V-twin, snorkeled, liquid-cooled
	Fuel Delivery System	Intelligent Throttle Control (ITC™) with Electronic Fuel Injection (EFI)	Intelligent Throttle Control (ITC™) with Electronic Fuel Injection (EFI)	Intelligent Throttle Control (ITC™) with Electronic Fuel Injection (EFI)
	Transmission	CVT L / H / N / R / P	CVT L / H / N / R / P	CVT Extra low L / H / N / R / P
	Drive Train	Selectable 2WD / 4WD with Visco-Lok® QE auto-locking front differential	Selectable 2WD / 4WD / Lock 4WD with Visco-4LoK® front differential	Selectable 2WD / 4WD / Lock 4WD with Visco-4LoK® front differential
	Driving Assistance	Work / Standard / Sport modes Intelligent Engine Braking (IEB™)	Work / Standard / Sport modes Intelligent Engine Braking (IEB™)*	Work / Standard / Sport modes Intelligent Engine Braking (IEB™)
	Power Steering	Tri-Mode Dynamic Power Steering (DPS™)	Tri-Mode Dynamic Power Steering (DPS™)	Tri-Mode Dynamic Power Steering (DPS™)
	SUSPENSIONS	Front Suspension	Arched double A-arm with sway bar 9.2 in. (23.3 cm) travel	Arched double A-arm with sway bar
Front Shocks		FOX® 1.5 PODIUM® RC2	SHOWA Internal Floating Piston (IFP) Shocks	FOX® 1.5 PODIUM® QS3
Rear Suspension		Torsional Trailing arm Independent (TTI) 9.9 in. (25.1 cm) travel	Torsional Trailing arm Independent (TTI)	Torsional Trailing arm Independent (TTI)
Rear Shocks		FOX® 1.5 PODIUM® RC2	SHOWA Internal Floating Piston (IFP) Shocks	FOX® 1.5 PODIUM® QS3
TIRES / WHEELS	ITP® Holeshot® ATR 25 x 8/11 x 12 in. 12 in. cast aluminum beadlock	ITP® Mega Mayhem® 28 x 8/10 x 12 in. 12 in. cast aluminum beadlock	ITP® Cryptid 30 x 9/9 x 14 in. 14 in. cast-aluminum beadlock	
BRAKES	Front	Dual 214 mm disc brakes with hydraulic twin-piston calipers	Dual 214 mm disc brakes with hydraulic twin-piston calipers	Dual 214 mm disc brakes with hydraulic twin-piston calipers
	Rear	Single 214 mm disc brake with hydraulic twin-piston caliper	Single 214 mm disc brake with hydraulic twin-piston caliper	Single 214 mm disc brake with hydraulic twin-piston caliper
DIMENSIONS / CAPACITIES	Estimated Dry Weight*	795 lb (361 kg)	870 lb (395 kg)	971 lb (440 kg)
	L x W x H	86 x 48 x 49 in. (218.4 x 121.9 x 124 cm)	83 x 50 x 56 in. (224 x 127 x 131 cm)	83 x 50 x 56 in. (224 x 127 x 131 cm)
	Wheelbase	51 in. (129.5 cm)	51 in. (129.5 cm)	51 in. (129.5 cm)
	Ground Clearance	10.5 in. (26.7 cm)	12 in. (30.5 cm)	12.5 in. (31.8 cm)
	Seat Height	34.5 in. (87.7 cm)	35.3 in. (89.5 cm)	36.8 in. (93.3 cm)
	Rack Capacity	Rear: 35 lb (16 kg)	Rear: 35 lb (16 kg)	Rear: 35 lb (16 kg)
	Storage Capacity	N/A	N/A	N/A
	Towing Capacity	1,300 lb (590 kg)	1,300 lb (590 kg)	1,300 lb (590 kg)
	Bed Capacity	N/A	N/A	N/A
Fuel Capacity	5.4 gal (20.5 L)	5.4 gal (20.5 L)	5.4 gal (20.5 L)	
FEATURES	Gauge	4.5 in. digital display	4.5 in. digital display	4.5 in. digital display
	Magneto	650 W	650 W	650 W
	Instrumentation	DC outlet, 15 A connector	DC outlet, 15 A connector	DC outlet, 15 A connector
	Ignition	RF Digitally Encoded Security System (D.E.S.S.™)	RF Digitally Encoded Security System (D.E.S.S.™) with cord	RF Digitally Encoded Security System (D.E.S.S.™) with tether
	Lighting	LED headlights	LED headlights	LED headlights
	Winch	Prewired for available winch	Prewired for available winch	Can-Am HD3500 (1,588 kg) winch with synthetic cable
	Seat	Standard	Standard	Standard
	Handlebar	Aluminum taper-profile handlebar with full wrap handguards	Aluminum taper-profile handlebar with grab handle and full wrap handguards	Aluminum taper-profile handlebar with grab handle and full wrap handguards
	Protection	Front bumper Front and central skid plate	MUD front bumper Rear bumper Front & central aluminum skid plate Handguards Lower front mudflap	MUD front bumper Rear bumper Front & central aluminum skid plate Handguards Lower front mudflap

† Visco-Lok is a trademark of GKN Viscodrive GmbH. All other trademarks are the property of their respective owners.

* Base model dry weight shown.

*** 1-year BRP limited warranty, B.E.S.T. term available up to 48 months.

					
		YOUTH RENEGADE***	YOUTH RENEGADE X XC***	YOUTH DS***	
COLOR OPTIONS		Catalyst Grey Iceberg Blue & Black		Black & Legion Red	Black & Can-Am Red
ENGINES	Type	70 EFI	110 EFI	110 EFI	250
		4-stroke single-cylinder, air-cooled	112 cc 4-stroke single-cylinder, air-cooled	112 cc 4-stroke single-cylinder, air-cooled	250 cc 4-stroke single-cylinder, liquid-cooled
	Fuel Delivery System	Electronic Fuel Injection (EFI) with built-in throttle limiter		Electronic Fuel Injection (EFI) with built-in throttle limiter	Carburetion
	Transmission	CVT F / N / R		CVT F / N / R	CVT F / N / R
	Drive Train	Chain driven / 2WD Electric starting system		Chain driven / 2WD Electric starting system	Chain driven / solid axle
	Driving Assistance	N/A		N/A	N/A
	Power Steering	N/A		N/A	N/A
SUSPENSIONS	Front Suspension	Single A-arm 5 in. (12.7 cm) travel		Double A-arm 5.5 in. (14 cm) travel	Double A-arm 5.5 in. (14 cm) travel
	Front Shocks	Twin-tube		Gas with piggyback reservoirs	Twin-tube
	Rear Suspension	Swingarm 6 in. (15.2 cm) travel		Swingarm 6 in. (15.2 cm) travel	Swingarm 6.7 in. (17 cm) travel
	Rear Shocks	Twin-tube		Gas	Twin-tube
TIRES/ WHEELS	Tires Wheels	17 x 7/8 x 8 in. 8 in. steel	Front: 19 x 7 x 8 in. Rear: 18 x 9.5 x 8 in. 8 in. steel	Front: 19 x 7 x 8 in. Rear: 18 x 9.5 x 8 in. 8 in. steel	Front: Kenda 22 x 7 x 10 in. Rear: Kenda 20 x 11 x 9 in. Front: 10 in. black steel / Rear: 9 in. black steel
BRAKES	Front	Dual drum brakes		Dual drum brakes	Dual hydraulic disc brakes
	Rear	Single drum brake		Single drum brake	Single hydraulic disc brake
DIMENSIONS / CAPACITIES	Estimated Dry Weight*	290 lb (130 kg)	295 lb (134 kg)	310 lb (140 kg)	429 lb (195 kg)
	L x W x H	59 x 38 x 36 in. (150 x 97 x 92 cm)	60.6 x 40.4 x 38.6 in. (154 x 103 x 98 cm)	60.6 x 42 x 38.6 in. (154 x 108 x 98 cm)	72 x 40.5 x 43.5 in. (183 x 103 x 110.5 cm)
	Wheelbase	39 in. (99 cm)	41 in. (105 cm)	41 in. (105 cm)	47 in. (118.7 cm)
	Ground Clearance	7.3 in. (18.5 cm) under frame / 3.5 in. (9 cm) under rear axle	8.3 in. (21.1 cm) under frame / 4.5 in. (11.4 cm) under rear axle	8.3 in. (21.1 cm) under frame / 4.5 in. (11.4 cm) under rear axle	10.2 in. (26 cm) center of ATV / 4.5 in. (11.4 cm) under rear axle
	Seat Height	26 in. (68 cm)	28 in. (71 cm)	28 in. (71 cm)	31.5 in. (80 cm)
	Rack Capacity	N/A		N/A	N/A
	Storage Capacity	N/A		N/A	N/A
	Towing Capacity	N/A		N/A	N/A
	Bed Capacity	N/A		N/A	N/A
	Fuel Capacity	1.6 gal (6 L)		1.6 gal (6 L)	1.6 gal (6 L)
FEATURES	Gauge	Neutral, reverse, fuel level and check engine lights		Neutral, reverse, fuel level and check engine lights	Neutral light, reverse light and oil/temperature light
	Magneto	N/A		N/A	N/A
	Instrumentation	N/A		N/A	N/A
	Ignition	Mechanical key		Mechanical key	Mechanical key
	Lighting	Halogen running headlights		Halogen running headlights	1
	Winch	N/A		N/A	N/A
	Seat	Standard		Standard	Standard
	Handlebar	Ergonomics and controls sized for 6 years old and up	Ergonomics and controls sized for 10 years old and up	Sport handguards Ergonomics and controls sized for 10 years old and up	Standard
	Protection	Front bumper Removable footboards spacers with height extenders	Front bumper	Front bumper	N/A
	Hitch Type	N/A		N/A	N/A

†Visco-Lok is a trademark of GKN Visco-drive GmbH. All other trademarks are the property of their respective owners.

*Base model dry weight shown.

***1-year BRP limited warranty.

G2, G2L, G2S ACCESSORIES



G2, G2L, G2S ACCESSORIES

LinQ: Easy On, Easy Off Cargo	23
Racks & Holders	28
Cargo & Storage	29
Windshields	30
Handlebars & Mirrors	31
Seats	31
HMWPE Skid Plates	32
Aluminum Skid Plates	33
HMWPE & Aluminum Skid Plates	35
Bumpers & Guards	36
Lights & Electrical	38
Winches	41
Hitches	42
Performance	43
Covers, Decals & Add-Ons	45
Apache Track Systems	46
ProMount Plows	50



LINQ: EASY ON, EASY OFF CARGO

LINQ ACCESSORIES

COMPATIBILITY/REQUIREMENTS

<ul style="list-style-type: none"> • No tools needed: Quickly install and remove accessories by hand. • Equip your Can-Am for specialized tasks in no time. • Sturdy mounting system that holds up to the roughest terrain. 	OUTLANDER 450/570	OUTLANDER	RENEGADE
LinQ ACCESSORIES WITH 16" BASE	<ul style="list-style-type: none"> • LinQ® anchors mounted 16 inches apart, center-to-center. • Lower loading capacity than the LinQ with 36" base accessories. • Can be used on Can-Am ATV and SxS vehicles, Can-Am Spyder and Ryker vehicles, Sea-Doo watercraft and Ski-Doo snowmobiles. 		
LinQ Rigid Cooler (18 L) 715010491	LinQ Adapter Plate 715007273 & LinQ Base Installation Kit 715008125	LinQ Anchor Adapter Kit 715004960 & LinQ Base Installation Kit 715008125	LinQ Luggage Rack 715001734 & LinQ Anchor Adapter Kit 715004960 OR LinQ Adapter Plate 715007274 & LinQ Base Installation Kit 715008125
LinQ Tool Box 715008111			
LinQ SR 5.5 Gal (21 L) Bag 860202449			
LinQ 4.5 Gal (17 L) Sport Bag 860202447			
LinQ Modular Box 715005494 • (10 L) 715007112 • (20 L) 715006830 • (30 L)			
LinQ Tool Kit 715006829			
LinQ 10.6 Gal (40 L) Roll-Top Bag 715008110			
LinQ ACCESSORIES WITH 36" BASE	<ul style="list-style-type: none"> • Mount on LinQ racks often used by Can-Am ORV vehicles. • Higher loading capacity than the LinQ with 16" base accessories. • Usage is limited to Can-Am ORV vehicles. 		
LinQ 12 Gal (45 L) Cargo Box 715003879	LinQ Base 715002350	No further requirements	LinQ Luggage Rack 715001734
LinQ 23 Gal (86 L) Trunk Box 715004923	No compatibility		
LinQ 32 Gal (121 L) Trunk Box 715001747 (1-up) 715001749 (MAX)	LinQ Base 715002350		
LinQ 11.5 Gal (43 L) Audio Cargo Box 715003018	No compatibility		
LinQ 8 Gal (30 L) Cooler Box 715004778 • Black	LinQ Base 715002350		
LinQ Premium Storage Bag by OGIO 715002923 • Black	LinQ Base 715002350		
LinQ Heavy Duty Basket 715001215	LinQ Base 715002350		
LinQ Low Profile Basket 715004282	LinQ HOLDERS	No further requirements	LinQ Luggage Rack 715001734
LinQ 4" (10 cm) Rack Extension 715001711 • Silver / 715001665 • Black	Not compatible <i>*Alternative 5" Rack Extensions (715001913) are available for G2L</i>		
LinQ 6" (15 cm) Rack Extension 715001712 • Silver / 715001671 • Black	LinQ Base 715002350		
LinQ Mounted Gear Grips 715005340	LinQ Base 715002350		
LinQ Tool Holder 715007358	Not compatible <i>*Alternative Gun Boot Rack (715001919) is available for G2L</i>		No compatibility

The LinQ system is BRP's game-changing, tool-free cargo solution. Snap gear on or off in seconds. No fuss, no rattle, just rock-solid mounting on any terrain.

LINQ SYSTEM ADVANTAGE

ORIGINAL LinQ SYSTEM

Handles medium- to large-sized gear with two anchor setups: the 16" base for standard accessories and the 36" base for racks and serious payloads.

LinQ LITE

Made for smaller items and lightweight gear you can hang from rails or vertical mounts.



LinQ ACCESSORIES WITH 16" BASE

NEW LinQ Rigid Cooler (18 L)

G2, G2L, G2S

715010491

\$394.04



- Versatile LinQ 16" configuration fits many vehicles.
- Durable rotomolded rigid construction.
- Molded-in handles for quick installation and removal.
- High quality insulation for optimal ice retention.
- Sealed lid for airtight, weather-tight closure.
- Ergonomic and secure latch system offers excellent sealing.
- 4.7 US gal (18 L) capacity.

LinQ Modular Box

G2, G2L, G2S

715005494 • (10 L)

\$148.99

715007112 • (20 L)

\$170.49

715006830 • (30 L)

\$191.49



- Allows stacking of other modular boxes to always have the right gear accessible.
- Always have the right box size to fit everything.
- Can be installed on any LinQ Base with a 16" width.
- See table for installation location and requirements.

Thermal Insert for LinQ Modular Box (10 L)

G2, G2L, G2S

219401110

\$63.99



- Insulated liner.
- Fits very well in the LinQ Modular Box (10 L).
- Can contain seven 355 ml cans.
- Keeps ice cold for one day.
- Interior dimensions: 9" L x 17" W x 2½" H.

LinQ Tool Kit	G2, G2L, G2S	715006829	\$352.99
----------------------	--------------	------------------	-----------------



- Includes:
 - Cutter pliers
 - Long-nose pliers
 - Locking pliers
 - Ratchet wrench 3/8" drive
 - 6" ratchet extension
 - Integrated CVT belt storage location (belt not included)
 - Long-socket 19 mm 3/8" drive - 6 pts
 - Socket 18 mm 3/8" drive
 - Long-socket 17 mm 3/8" drive - 6 pts
 - Socket 15 mm 3/8" drive
 - Socket 13 mm 3/8" drive
 - Socket 10 mm 3/8" drive
 - Socket 8 mm 3/8" drive
 - Socket Torx T40 3/8" drive
 - Socket Torx T30 3/8" drive
 - Socket Torx T20 3/8" drive
 - Breaker bar 3/8" drive
 - Combination wrench set:
 - Wrench 19 mm
 - Wrench 18 mm
 - Wrench 15 mm
 - Wrench 13 mm
 - Wrench 10 mm
 - Wrench 8 mm
 - See table for installation location and requirements.

LinQ Tool Box	G2, G2L, G2S	715008111	\$191.49
----------------------	--------------	------------------	-----------------



- High precision injected HDPE construction provides rigidity and durability.
- 5 gal (19 L) maximum capacity.
- Weather-resistant, sealed and lockable cover.
- Easy one-second on/off tool-less system. All the benefits of LinQ – simple, fast and secure.
- See table for installation location and requirements.

LinQ 10.6 Gal (40 L) Roll-Top Bag	G2, G2L, G2S	715008110	\$244.99
--	--------------	------------------	-----------------



- Fully waterproof roll-top dry bag will securely store and confine your equipment.
- LinQ mounted using heavy-duty rigid plastic base.
- High capacity storage solution 10.6 gal (40 L).
- Bottom foam liner for additional equipment protection.
- Integrated handle for easy transportation on/off the vehicle.
- Marinized for salt water purposes.
- Dimensions: 14" L x 19" W x adjustable H.
- See table for installation location and requirements.

SR 5.5 Gal (21 L) LinQ Bag	G2, G2L, G2S	860202449	\$244.99
-----------------------------------	--------------	------------------	-----------------



- Semi-rigid expandable bag.
- 5.5 gal (21 L) capacity.
- See table for installation location and requirements.

LinQ 4.5 Gal (17 L) Sport Bag	G2, G2L, G2S	860202447	\$223.49
--------------------------------------	--------------	------------------	-----------------



- All the benefits of LinQ – simple, fast and secure.
- 17 liter (4.5 US gallon) capacity.
- Thermoformed bag base in HDPE (high-density polyethylene) providing rigidity and durability.
- Premium insulating foam for optimal ice retention.
- Rigid bottom, semi-rigid top.
- Easy one-second on/off tool-less system.
- See table for installation location and requirements.

LinQ ACCESSORIES WITH 36" BASE

LinQ 12 Gal (45 L) Cargo Box	G2 (front only for 6x6 & MAX models 2013-2014), G2L, G2S	715003879	\$329.99
-------------------------------------	--	------------------	-----------------



- LinQ mounted for easy on, easy off installation.
- Holds cargo safely and securely while riding.
- See table for installation location and requirements.

LinQ 23 Gal (86 L) Trunk Box	G2 (except 6x6 models), G2L, G2S	715004923	\$393.99
-------------------------------------	----------------------------------	------------------	-----------------



- LinQ mounted for easy on, easy off installation.
- Lockable and weather-resistant.
- Holds cargo safely and securely while riding.
- Comfort pads for passenger.
- See table for installation location and requirements.

LinQ 32 Gal (121 L) Trunk Box	G2 (except MAX models & 6x6), G2S	715001747	\$577.99
	European Version (EC compliant)	715001748 • No rear taillight.	\$524.49



- LinQ Retrofit Adapter Plate (715001334) is required for G1 models.
- Trunk Box Panels available in many colors to match your vehicle (sold separately).
- See table for installation location and requirements.

LinQ 32 Gal (121 L) Trunk Box for Outlander MAX	G2 (MAX models only except 6x6 models)	715001749	\$673.99
	European Version (EC compliant)	715001750 • No rear taillight.	



- Passenger comfort is ensured on active rides as well as longer recreational rides thanks to the ergonomically designed passenger padding, which is comfort-fitted with a portion made of closed cell foam that won't absorb water.
- Very easy to embark even when driver is seated.
- Trunk Box Panels available in many colors to match your vehicle (sold separately).

LinQ 32 Gal (121 L) Trunk Box Panels	G2 (except 6x6 models), G2S	\$63.99
---	-----------------------------	----------------



- Color panels to match the LinQ 32 Gal (121 L) Trunk Box to your vehicle.
- **715001391** • Black

LinQ 11.5 Gal (43 L) Audio Cargo Box	G2 (front only for 6x6 & MAX models 2013-2014), G2L, G2S	715003018	\$829.99
---	--	------------------	-----------------



- Mounts on/off easily to hold/carry cargo safely and securely.
- The Bluetooth enabled receiver and 6.5" (16.5 cm) speakers are smartly concealed and integrated in the cover.
- Automatic shut-off function protects your battery by turning the system off after 10 minutes of inactivity.
- Backlit control panel perfect for night riding.
- Water-resistant speakers.
- Delivers the best sound quality on the market to sweeten your ride courtesy of a built-in full range high-efficiency amplifier.
- See table for installation location and requirements.

LinQ 8 Gal (30 L) Cooler Box	G2 (except 6x6 models), G2S	■ 715004778 • Black ■ 715004698 • Gray	\$469.99
-------------------------------------	-----------------------------	---	-----------------



- LinQ mounted for easy on, easy off installation.
- Rotomolded construction provides exceptional rigidity and durability.
- Premium-quality foam insulation for optimal ice retention.
- Integrated, fully-removable compartment protects food.
- Robust rubber latches keep the cover tightly closed.
- Weather-resistant.
- Convenient drain plug.
- See table for installation location and requirements.

LinQ Premium Storage Bag by OGIO	G2 (except 6x6 models), G2L, G2S	■ 715002923 • Black	\$532.49
---	----------------------------------	----------------------------	-----------------



- LinQ mounted for easy on, easy off installation.
- Holds cargo safely and securely while riding.
- See table for installation location and requirements.

LinQ Low Profile Basket	G2, G2L (front only for MAX & 6x6 models), G2S	715004282	\$223.49
--------------------------------	--	------------------	-----------------



- Low profile, open basket increases cargo space.
- Perfect for easy access to tools, rope, winch and plow accessories.
- Multiple bungee cord and tie-down anchor points.
- Made of impact-resistant injected polypropylene.
- See table for installation location and requirements.

LinQ Heavy-Duty Basket	G2, G2L (front only for MAX & 6x6 models), G2S	715001215	\$297.99
-------------------------------	--	------------------	-----------------



- Made of high-strength, low-alloy steel.
- LinQ mount for easy on, easy off installation.
- Can be placed on both front and back racks of vehicle.
- See table for installation location and requirements.

Large Cargo Box	G2, G2L (except 6x6)	715007001	\$681.49
------------------------	----------------------	------------------	-----------------



- Rear bed to carry large items.
- Anchor points (D-ring), LinQ fixtures for tool holder, and marks to allow the installation of a 16" accessory.
- Also has a mat for the floor and slot to enable the installation of a divider and a slot for a divider to close the recess on the rear vertical lip.
- It is installed on ATV platforms through the LinQ system and hooks to make it easy to install and remove.

LinQ HOLDERS

LinQ Tool Holder	G2, G2L, G2S	715007358	\$63.99
-------------------------	--------------	------------------	----------------



- Ultra-versatile tool holder.
- Convenient swivel-latch allows tools to be stored in any orientation.
- Sold in pairs.
- G2S: LinQ Luggage Rack (715001734) is required for installation.

LinQ Gear Grips	G2, G2L, G2S	715005340	\$160.49
------------------------	--------------	------------------	-----------------



- Durable and flexible grips provide a custom fit for a variety of items from 1" to 4" (2.5 cm to 10 cm) in diameter.
- Heavy-duty design for carrying bows, fishing poles, rakes, farm tools and more.
- Quick-release button opens grip quickly for easy access to gear.
- Heavy-duty base system built for the toughest adventures.
- Make transporting your tools a snap by combining the Gear Grips with the LinQ system.
- 360° orientation.
- Sold in pairs.

LinQ MOUNTING

LinQ Anchor Adapter Kit	G2, G2S	715004960	\$84.99
--------------------------------	---------	------------------	----------------



- Allows the installation of accessories with 16" LinQ Base on LinQ racks.
- Tool-less installation and removal.
- For G2S, the LinQ Luggage Rack (715001734) is required for installation.

LinQ Base	G2L	715002350	\$25.99
------------------	-----	------------------	----------------



- Made of glass fiber reinforced polypropylene.
- Allows you to install LinQ accessories.
- Sold in pack of 4.

LinQ Lock	G2, G2L, G2S	860201968	\$66.99
------------------	--------------	------------------	----------------



- Simple way to securely lock most LinQ accessories.
- Lock cover protects lock from the elements.
- Corrosion resistant.
- Pack of 1, includes 2 keys.
- Not compatible with LinQ 4.2 US Gal (16 L) Cooler, LinQ Tool Box, LinQ Tool Holder and LinQ Gear Grips.

LinQ Replacement Parts		715010798	\$42.49
-------------------------------	--	------------------	----------------



- Unique mounting fastener usable on any LinQ system accessory.
- Tool-less installation and removal.
- Sold in pairs.

RACKS & HOLDERS

LinQ Rack Extension – 4" (10 cm)	G2, G2S	<ul style="list-style-type: none">  715001711 • Silver  715001665 • Black 	\$255.49
	<ul style="list-style-type: none"> • Fits front or rear. • Strong and durable. • Helps keep cargo securely in place. • Easy and tool-less installation thanks to the LinQ system. • Anti-corrosion coating with durable powder coat finish. • LinQ Luggage Rack (715001734) is required for G2S. 		
LinQ Rack Extension – 6" (15 cm)	G2, G2S	<ul style="list-style-type: none">  715001712 • Silver  715001671 • Black 	\$265.99
	<ul style="list-style-type: none"> • Fits front or rear. • Strong and durable. • Helps keep cargo securely in place. • Easy and tool-less installation thanks to the LinQ system. • Anti-corrosion coating with durable powder coat finish. • LinQ Luggage Rack (715001734) is required for G2S. 		
Rack Extension – 5" (13 cm)	G2L	715001913	\$148.99
	<ul style="list-style-type: none"> • Fits front or rear. • Made of carbon steel. • Provides tie-down points to secure cargo on racks. • Easy installation on tubular rack. • Anti-corrosion coating with durable powder coat finish. 		
LinQ Luggage Rack	G2S (except X mr models)	715001734	\$340.99
	<ul style="list-style-type: none"> • Bolt-on rack. • Enables use of LinQ mounted accessories on the G2S. 		
LinQ Base Plate	G2L	715007273	\$127.99
	<ul style="list-style-type: none"> • Enables use of 16" wide LinQ Base accessories on G2L to extend cargo options and journey opportunities. • Requires LinQ Base Kit (715008125). 		
LinQ Base Plate	G2S	715007274	\$159.49
	<ul style="list-style-type: none"> • Enables use of 16" wide LinQ Base accessories on G2S to extend cargo options and journey opportunities. • Requires LinQ Base Kit (715008125). 		
Gun Boot Rack	G2L (MAX models only)	715001919	\$164.99
	<ul style="list-style-type: none"> • Made of steel. • Designed for the tubular rack. • For use with Gun Boot 6.0 Impact by Kolpin. • Can be mounted to either side of the vehicle. 		
Gun Boot 6.0 Impact [†] by Kolpin [†]	G2, G2L	715001419	\$114.99
	<ul style="list-style-type: none"> • Extra room for pistol-grip-type weapons and small bipods. • Easily fits firearms up to 51" (130 cm) in total length. • Provides ample room for 2$\frac{3}{8}$" (60 mm) scopes. • Hatchback design allows easy access. • Ergonomically designed handle and molded attachment points for sling. <ul style="list-style-type: none"> • Snap-close cover with locking capability. • Designed to accommodate left and right hand bolt-action rifles and shotguns. • Includes removable, shock absorbing foam and nylon impact liner for superior interior protection. • Requires appropriate mounting kit for installation. 		
LinQ Gun Boot Rack <i>(Not illustrated)</i>	<ul style="list-style-type: none"> G2 (except MAX, 6x6 & X mr 1000) G2 (MAX & X mr 1000 models only) 	<ul style="list-style-type: none"> 715002112 715002113 	<ul style="list-style-type: none"> \$196.99 \$154.49
<ul style="list-style-type: none"> • This lightweight Gun Boot Rack can be mounted on either side of your Outlander using the tool-less LinQ system. • For use with Gun Boot 6.0 Impact by Kolpin. 			

Multi-Fit Holder	G2, G2L	715002354 • Single	\$64.99
		715001945 • Double	\$104.99
	<ul style="list-style-type: none"> • Open U-shaped bracket for carrying tools (shovel, axe) and hunting weapons (rifle, bow) that are safely secured, but easily accessible. • Easy installation on tubular rack, extension racks, basket or bumpers. • For G2, the LinQ Rack Extension (715001711) is required. • Sold in pairs. 		

Gear Grips	G2L	715001421	\$99.49
	<ul style="list-style-type: none"> • Durable, flexible grips cushion and protect while providing a custom fit for a variety of items from 1" to 4" (2.5 cm to 10 cm) in diameter. • Heavy-duty design for carrying bows, fishing poles, rakes, farm tools and more. • Quick-release button opens grip quickly for easy access to gear. • Heavy-duty base system built for the toughest adventures. • Easy installation on tubular racks, extension racks, brackets or bumpers. • Sold in pairs. 		

CARGO & STORAGE

Hard Top	G2 (6x6 models only)	715002394	\$1,139.99
	<ul style="list-style-type: none"> • The hard top provides a 116 gal (440 L) cargo box. • Locking secures your belongings. • The cover raises assisted by gas cylinders. 		

Cargo Box Pool	G2L (6x6 models only)	715005256	\$415.49
	<ul style="list-style-type: none"> • Transforms the flatbed into a large capacity cargo box for increased loading possibilities. • Made of durable formed HDPE and shaped to maximize cargo space. • Allows access to vehicle's water-resistant rear compartment. • Designed for perfect fit and easy installation. 		

Tarpaulin	G2 (6x6 models only)	715002416	\$425.49
	<ul style="list-style-type: none"> • Fitted to cover all of the items in your cargo box completely. • Prevents splash from entering cargo box. • Easily removable for quick access. 		

18 Gal (70 L) Utility Box	G2 (6x6 models only)	715001999	\$595.99
	<ul style="list-style-type: none"> • Wherever you go and whatever you do, this handy 18 gal (70 L) utility box is your mobile storage. • The lid keeps your equipment safe from the elements in all conditions. • Slides under the flatbed with handles for easy access. 		

Cargo Box Net	G2 (6x6 models only)	715001371	\$76.49
	<ul style="list-style-type: none"> • Solid net designed to hook to the bottom of the cargo box for secure and compact confinement of your cargo. 		

Soft Storage Bag	G2, G2L, G2S	715003759	\$191.49
	<ul style="list-style-type: none"> • 3-section bag. • Transport gear in a weatherproof bag. • 11.8 gal (45 L) capacity soft cargo bag designed with vehicle's rack in mind to maximize potential storage. • LinQ Luggage Rack (715001734) is required for G2S. 		

Storage 2.6 Gal (10 L) Bag		269502121	\$40.49
	<ul style="list-style-type: none"> • Roll-top dry bag for fully protecting your cargo from the elements. • Fits in rear compartment of your vehicle. 		

WINDSHIELDS

Deluxe Fairing	G2 (except X mr & 6x6), G2L	<ul style="list-style-type: none"> ■ 715001232 • Black ■ 715007073 • Tundra Green 	\$276.49
-----------------------	-----------------------------	---	-----------------



- Innovative, richly featured wind protection.
- Quick tool-less removal once base brackets are mounted on handlebar.
- Two cup holders.
- Ready for GPS mounting kit.
- Optional mirrors and auxiliary lighting.
- Requires low, high or extra high windshield.
- Tapered Handlebar Adapter Kit is required for vehicles with 1½" (28 mm) tapered aluminum handlebars.

Tapered Handlebar Adapter Kit <i>(Not illustrated)</i>	Deluxe Fairing	715002470	\$35.49
--	----------------	------------------	----------------

- Required to install Deluxe Fairing on an Outlander X-TP and on any vehicle equipped with 1½" (28 mm) tapered aluminum handlebars.

Extra High Windshield	Deluxe Fairing	715000936	\$129.99
------------------------------	----------------	------------------	-----------------



- 16" (41 cm) windshield provides the ultimate protection against the elements while touring.
- For wind protection and winter applications.
- Tool-less installation and replacement.

High Windshield	Deluxe Fairing	715001211	\$85.99
------------------------	----------------	------------------	----------------



- 11" (28 cm) high, for wind protection and winter applications.
- Tool-less installation and replacement.

Low Windshield	Deluxe Fairing	715001227	\$79.99
-----------------------	----------------	------------------	----------------



- 6" (15 cm) windshield allows you to keep your vehicle looking sporty while giving you some protection from the elements and the possibility of enjoying directional lighting.
- Tool-less installation and replacement.

ACCESSORIES

Auxiliary Windshield Lighting	Deluxe Fairing	715003115	\$418.99
--------------------------------------	----------------	------------------	-----------------



- 2 premium LED spots for Deluxe Fairing for both increased output and directional lighting.
- 1,800 lumens.
- 2 x 10 W LED Cree light kit.
- Long-range illumination up to 350' (107 m), drawing less than 1 amp per light.

Deluxe Mirror Kit	Deluxe Fairing	715002353	\$76.49
--------------------------	----------------	------------------	----------------



- Improved mounting system.
- Wide rear view.
- Perfect fit with your Deluxe Fairing.

WINDSHIELD KITS

Extra High Windshield Kit	G2, G2L, G2S (except X mr models)	715003023	\$299.99
----------------------------------	-----------------------------------	------------------	-----------------



- Made of polycarbonate with integrated vent to reduce air turbulence and rumble noise at high speeds for a quieter and smoother ride.
- Quick tool-less removal once base brackets are mounted on handlebar.
- Fits straight and tapered handlebars.
- Improved design for enhanced rigidity.
- Steering Cover (709400939) is required for XT and Mossy Oak models.
- 16" (41 cm) windshield.
- For ultimate wind protection and winter applications.

High Windshield Kit	G2, G2L, G2S (except X mr models)	715006382	\$259.99
----------------------------	-----------------------------------	------------------	-----------------





- Made of polycarbonate with integrated vent to reduce air turbulence and rumble noise at high speeds for a quieter and smoother ride.
- Quick tool-less removal once base brackets are mounted on handlebar.
- Fits straight and tapered handlebars.
- Improved design for enhanced rigidity.
- Steering Cover (709400939) is required for XT and Mossy Oak models.
- 11" (28 cm) windshield.
- For wind protection and winter applications.

Low Windshield Kit	G2, G2L, G2S (except X mr models)	715003021	\$219.99
	<ul style="list-style-type: none"> Made of polycarbonate with integrated vent to reduce air turbulence and rumble noise at high speeds for a quieter and smoother ride. Quick tool-less removal once base brackets are mounted on handlebar. Fits straight and tapered handlebars. 	<ul style="list-style-type: none"> Improved design for enhanced rigidity. Steering Cover (709400939) is required for XT and Mossy Oak models. 6" (15 cm) windshield. Allows you to keep your vehicle looking sporty while giving you some protection from the elements. 	

HANDLEBARS & MIRRORS

Handlebar Wind Deflectors	G2, G2L, G2S		\$34.99
	<ul style="list-style-type: none"> Rugged injected plastic construction with Can-Am logo. Include removable cap for air flow adjustment. Mounting kit sold separately. 	<ul style="list-style-type: none"> 715000525 • Black / Yellow 715001706 • Black / Black 715003811 • Can-Am Red / Black 715003812 • Manta Green / Black 715003814 • Octane Blue / Black 715006118 • Viper Red / Black 	

Passenger Wind Deflectors	G2 and G2L (MAX models only)	715001669	\$98.99
	<ul style="list-style-type: none"> These wind deflectors fit on the passenger handles and provide greater comfort while riding. Easy to install and remove. 		

Full Wrap Aluminum Mounting Kit	G2, G2L, G2S	715001378	\$138.49
	<ul style="list-style-type: none"> Lightweight black die cast aluminum construction. Includes complete hardware. Handlebar wind deflectors sold separately. 		

Aluminum Tapered Handlebar	G2, G2L, G2S	715000550	\$127.49
	<ul style="list-style-type: none"> 7/8" – 1 1/8" (22 mm – 28 mm) tapered handlebar made of 6061-T6 aluminum. Includes all hardware, center steering foam and cover. 		

Mirrors Left – 3/8" (10 mm)	G2, G2L, G2S	708200963	\$35.99
	<ul style="list-style-type: none"> Adjustable handlebar mounted convex mirrors. The convex surface allows improved visibility with a wider field of view. Matte finish. 	<ul style="list-style-type: none"> Stem includes 3/8" (10 mm) thread. Bracket (715000190) is required for installation on DS 450. Bracket not required for installation on Outlander and Renegade. 	

Mirrors Right – 3/8" (10 mm) <i>(Not illustrated)</i>	G2, G2L, G2S	709400523	\$35.99
	<ul style="list-style-type: none"> True vision surface 5" x 3" (13 cm x 8 cm). Matte finish. Stem includes 3/8" (10 mm) thread. 	<ul style="list-style-type: none"> Bracket (715000190) required except for vehicles with right hand brake. 	

Handlebar Mirrors	G2, G2L, G2S	715005366	\$74.49
	<ul style="list-style-type: none"> Adjustable handlebar mounted convex mirrors. The convex surface allows improved visibility with a wider field of view. Doesn't require a windshield or fairing to be mounted. Works with all windshield options. 		

SEATS

Outlander MAX Passenger Seat Kit	G2 2015 & up, G2L (MAX models only)	715002373	\$745.49
	<ul style="list-style-type: none"> Perfect to replace used or damaged passenger's seat. 		

HMWPE SKID PLATES

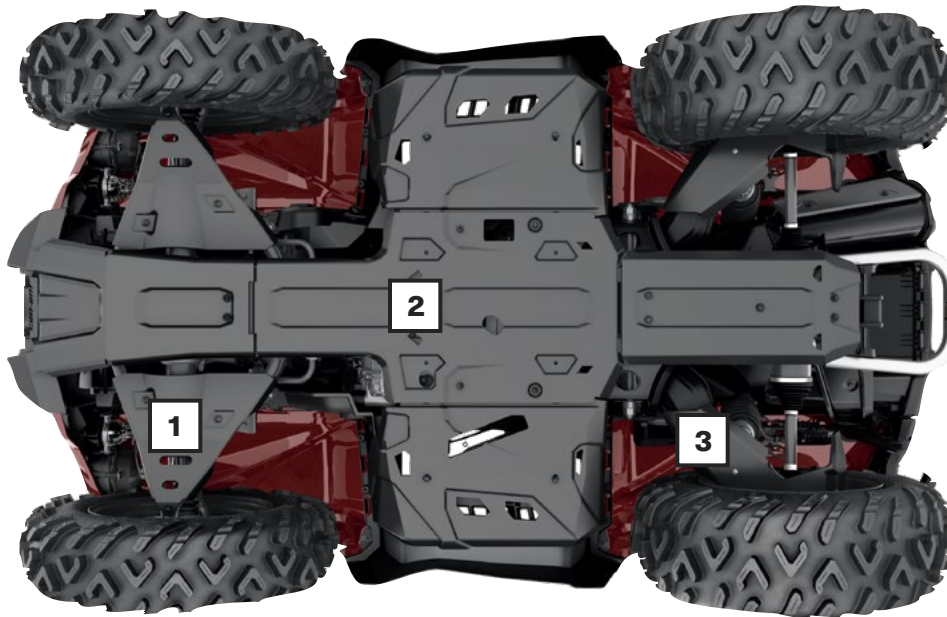

Our plastic plates glide smoothly and silently over obstacles, offering great protection in rough terrain. Made of ¼" (6 mm) thick abrasion-resistant thermoformed high molecular weight polyethylene (HMWPE).

- Lighter than aluminum.
- Superior stress crack resistance.
- High impact strength.

OUTLANDER, RENEGADE

G2		G2L		G2S					
2016 & Prior		2017-2018		2019 & Up				2017-2018	2019-2022
Except MAX & X mr 1000R models	MAX & X mr 1000R models only	Except MAX & X mr 1000R models	MAX & X mr 1000R models only	Except MAX & X mr 1000R models	MAX & X mr 1000R models only	Except MAX models	MAX models only		

HMWPE SKID PLATE PROTECTION KIT

715004214	715004215	715004209	715004210	715004806	715004807	715004211	715004212	715004213	715004809
-----------	-----------	-----------	-----------	-----------	-----------	-----------	-----------	-----------	-----------

INDIVIDUAL HMWPE SKID PLATES

	2016 & Prior	2017-2018	2019 & Up	2017-2018	2019-2022
1 A-Arm Protectors	715002924	715002924	715002924	715002924	715004822
2 Underbelly Plates <i>Footwell portion not compatible with Renegade X mr</i>	715002926	715002927	715002926	715002927	715002926
3 Trailing Arm Protectors	-	-	715003466	715003466	715004823

ALUMINUM SKID PLATES

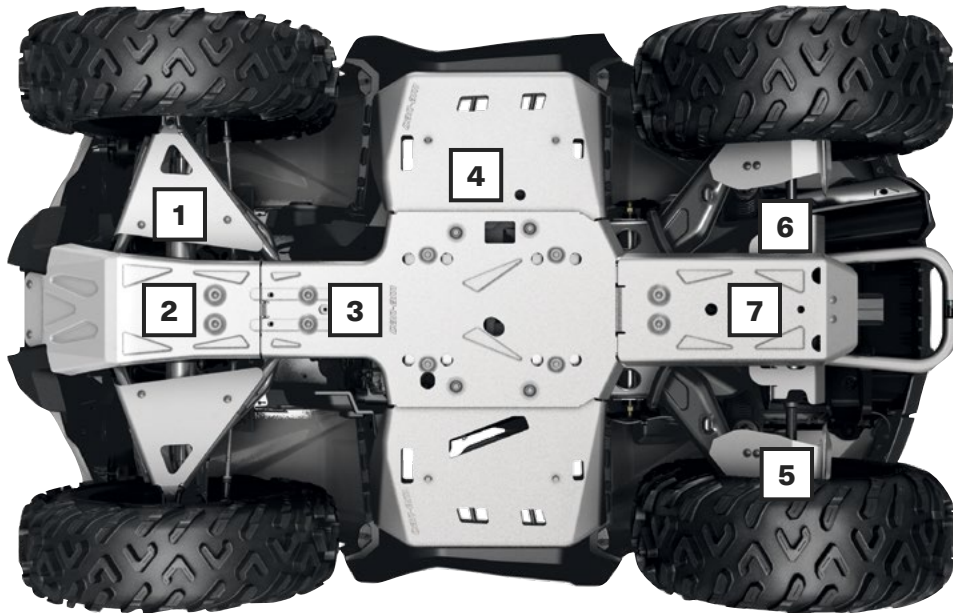

For ultimate durability and strength, all our Aluminum Skid Plates are made with $\frac{3}{16}$ " (4.5 mm) thick high strength 5052 H32 aluminum.

- Ultimate durability.
- High strength.

OUTLANDER

G2						G2L	
2016 & prior		2017-2018		2019 & Up		Any Year	
Except MAX & X mr 1000R models	MAX & X mr 1000R models only	Except MAX & X mr 1000R models	MAX & X mr 1000R models only	Except MAX & X mr 1000R models	MAX & X mr 1000R models only	Except MAX models	MAX models only

ALUMINUM SKID PLATE PROTECTION KIT

715002137	715002138	715004197	715004198	715004804	715004805	715004199	715004200
-----------	-----------	-----------	-----------	-----------	-----------	-----------	-----------

INDIVIDUAL ALUMINUM SKID PLATES

1 A-Arm Protectors	715001667	715001667	715001667	715001667	715004820	715004820	715001667	715001667
2 Front Skid Plate	715000926	715000926	715000926	715000926	715000926	715000926	715001906	715001906
3 Central Skid Plate	715002078	715002078	715002078	715002078	715002078	715002078	715002078	715002078
4 Footwell Protector Plates	715000922	715000922	715000922	715000922	715000922 (except X mr 850 models)	715000922	715000922	715000922
5 Trailing Arm Protectors	—	—	715008595	715008595	715004821	715004821	715008595	715008595
6 Rear Differential Protectors	715000920	715000920	715000920	715000920	715000920	715000920	715000920	715000920
7 Rear Skid Plate	715002028	715002029	715002028	715002029	715002028	715002029	715002028	715002029

ALUMINUM SKID PLATES

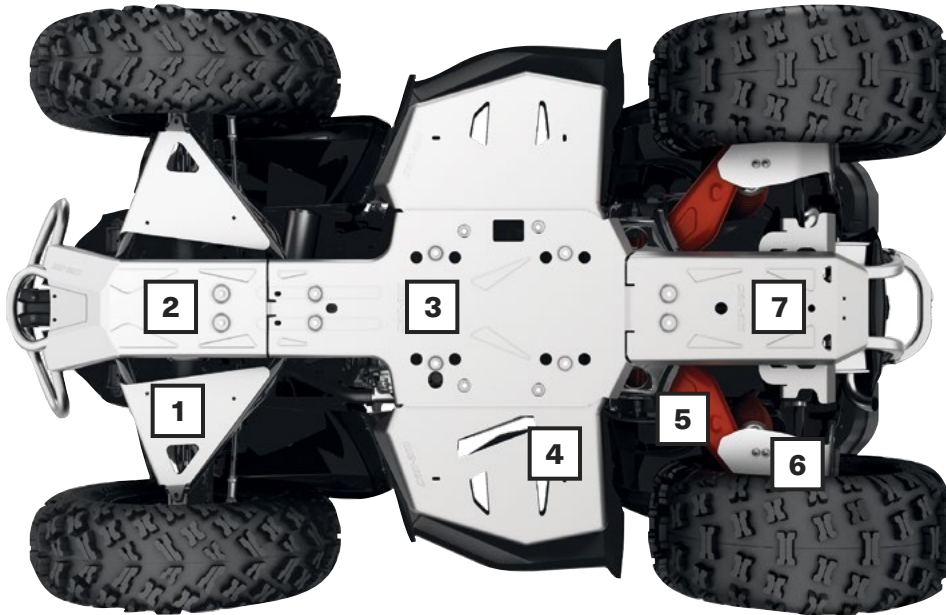

For ultimate durability and strength, all our Aluminum Skid Plates are made with $\frac{3}{16}$ " (4.5 mm) thick high strength 5052 H32 aluminum.

- Ultimate durability.
- High strength.

RENEGADE

G2S

	2016 & Prior	2017-2018	2019-2022	2023 & Up
ALUMINUM SKID PLATE PROTECTION KIT				
<i>Not compatible on X mr models</i>	715002139	715004201	715004808	715009730
INDIVIDUAL ALUMINUM SKID PLATES				
1 A-Arm Protectors	715001667	715001667	715004820	715004820
2 Front Skid Plate	715000925	715000925	715000925	715001906
3 Central Skid Plate	715002078	715002078	715002078	715002078
4 Footwell Protector Plates <i>Not compatible on X mr models</i>	715001359	715001359	715001359	715001359
5 Trailing Arm Protectors		715008595	715004821	715004821
6 Rear Differential Protectors	715000920	715000920	715000920	715000920
7 Rear Skid Plate	715002028	715002028	715002028	715002028

HMWPE & ALUMINUM SKID PLATES

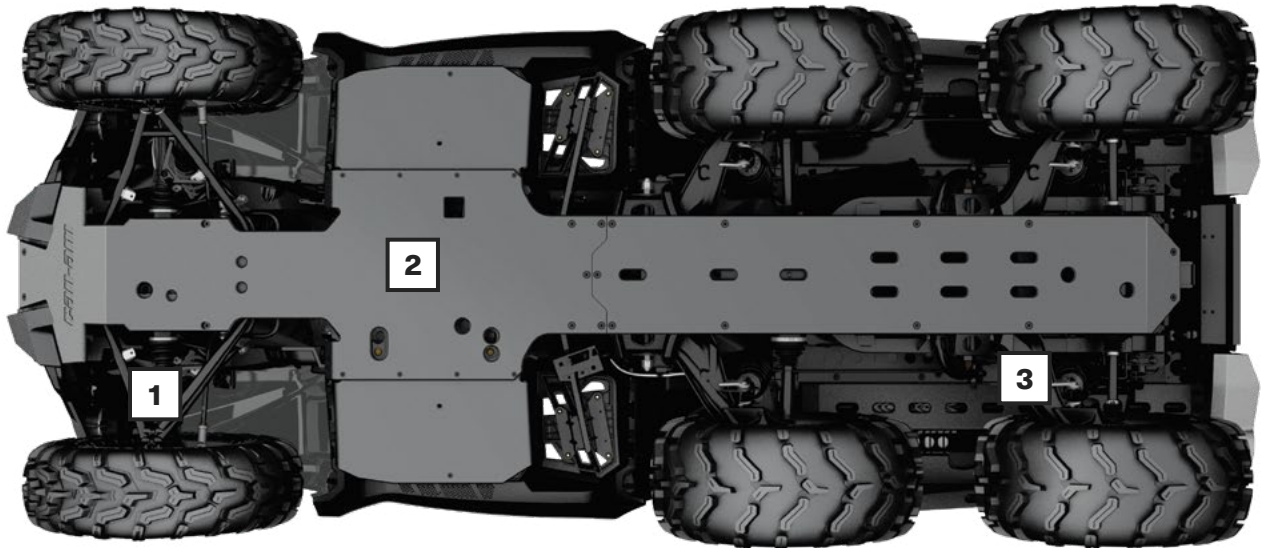

Our Plastic and Aluminum Plates glide smoothly and silently over obstacles, offering great protection in rough terrain.

HMWPE

Made of ¼" (6 mm) thick abrasion resistant thermoformed high molecular weight polyethylene (HMWPE).

- Lighter than aluminum.
- Superior stress crack resistance.
- High impact strength.

ALUMINUM

Made with high strength ¾" (4.5 mm) thick 5052 H32 aluminum.

- Ultimate durability.
- High strength.

OUTLANDER 6X6

	G2 6X6			G2L 6X6
	2016 & Prior	2017-2018	2019 & Up	Any Year
INDIVIDUAL HMWPE SKID PLATES				
1 HMWPE A-Arm Protectors	715002924	715002924	715004822	715002924
2 HDPE Full Underbelly Skid Plate	715005290 (except MAX)	715005290	715005290 (except MAX)	715005259 (MAX only)
	715005320 (MAX only)	715005320	715005320 (MAX only)	
3 HMWPE Trailing Arm Protectors	-	715003466	715004823	715003466 (2020 models & prior only)
INDIVIDUAL ALUMINUM SKID PLATES				
1 Aluminum A-Arm Protectors	715001667	715001667	715004820	715001667
2 Aluminum Full Underbelly Skid Plate	-	-	-	-
3 Aluminum Trailing Arm Protectors	-	715008595	715004821	715008595

BUMPERS & GUARDS

BUMPERS

Expedition Front Bumper	G2, G2L (except X mr models & X xc models 2022 & up)	715007233	\$319.49
--------------------------------	--	------------------	-----------------



- Made of 1.5" profiled steel tubes for complete protection of the vehicle's front.
- Protects and doesn't obstruct the vehicle's headlights.
- Integrated mounting spots for lights.
- Inside and outside anticorrosion coating with a durable powder coat finish.

Expedition Rear Bumper	G2, G2L	715007234	\$287.49
-------------------------------	---------	------------------	-----------------



- Made of 1.5" profiled steel tubes for complete protection of the vehicle's rear.
- Protects and doesn't obstruct the vehicle's taillights.
- Inside and outside anticorrosion coating with a durable powder coat finish.
- G2 base and DPS rear bumper installation requires 705008164 and 705008165.

X mr Front Bumper	G2S 2023 & up	715008198	\$308.99
--------------------------	---------------	------------------	-----------------



- Enhanced vehicle front protection. Required as a mounting point for Radiator Relocator (715008898).

XT Front Bumper	G2	715004837	\$223.49
------------------------	----	------------------	-----------------



- Provides additional protection against obstacles.
- Tough and durable, can be added on base Outlander model to convert vehicle into XT model.
- Standard on XT, XT-P, Mossy Oak and Limited models.
- Large tube construction with textured black finish and metal corners.

XT Rear Bumper	G2	715004920	\$223.49
-----------------------	----	------------------	-----------------



- Provides additional protection against obstacles.
- Tough and durable, can be added on base Outlander model to convert vehicle into XT model.
- Standard on XT, XT-P, Mossy Oak and Limited models.
- Large tube construction with textured black finish and metal corners.

XT Front Bumper	G2L	715001910	\$179.99
------------------------	-----	------------------	-----------------



- Winch compatible.
- Large tube construction.
- Protects vehicle against obstacles.
- Standard on XT models.

XT Rear Bumper	G2L	715001911	\$142.99
-----------------------	-----	------------------	-----------------



- Large tube construction.
- Protects vehicle against obstacles.
- Standard on XT models.

Extreme Front Bumper	G2	715001286*	\$329.99
	G2L	715004279	\$297.99



- Ultra-sturdy build.
- Enhances front-vehicle protection.
- Compatible with XT Front Bumper.
- Fits the Apache™ 360 Track System (when side panels are removed).

**Not compatible with Front Hitch.*

Rancher Rear Bumper	G2, G2L (except 6x6 models)	715003462	\$308.49
----------------------------	-----------------------------	------------------	-----------------



- Ideal for using your ATV within cattle herds and guarding the safety of both the vehicle and the animals.
- Coverage extends to provide an extra layer of defense to your taillights.
- Inside and outside anti-corrosion coating with durable powder coat finish.
- Not compatible with track systems.

Renegade Extreme Front Bumper	G2S 2022 and prior (except X mr models)	715002469	\$287.49
--------------------------------------	---	------------------	-----------------



- Enhanced vehicle front protection.
- Required as a mounting point for Radiator Relocator (715008898).

GUARDS

Body Side Protector	G2 2019 & up with XT Bumpers (except X mr, 6x6 and MAX models)	715004940*	\$404.99
----------------------------	--	-------------------	-----------------



- The heavy-duty fender guard designed to pull double duty, protecting your ATV and also enhancing the look of your ATV.
- Made tough and designed to deliver a rugged appearance, this fender guard offers full side protection for farmer, rancher and forestry applications.
- Durable and bold 1.25" (3 cm) diameter steel-tube construction, with inside and outside anti-corrosion coating with durable powder coat finish.
- Not compatible with Self Clearing Footwell.
- XT Front and Rear Bumpers or Rancher Front and Rear Bumpers are required for installation.

**Not compatible with Front and Rear Rancher Bumpers.*

Mud Flaps	G2 (with stock fender flares)	715007089	\$62.99
------------------	-------------------------------	------------------	----------------



- Keep mud, snow and debris out of cargo area and protect trailer and vehicles behind you.
- Add aesthetic appearance to your vehicle.
- Require stock fender flares.
- Sold in pairs.

Fender Flares	G2 2012-2018 (except with 30" tires) (except 6x6 models)	715001764*	\$169.49
	G2 2019 & up (with 30" tires) (except 6x6 models)	715004250**	
	G2L	715001909***	
	G2L European vehicles only 2015 & up	715004487	



- Kit designed to deliver extra protection from dirt and debris, therefore a must if you enjoy riding in the mud.
- Made of injected plastic that hugs your vehicle fenders perfectly.
- Give vehicle added flair for that rugged cool look.
- Include front and rear extensions and all mounting hardware.

**Comes stock on G2 models 2019 & up (except X mr models).
 **Standard on G2 X mr 1000R.
 ***Not compatible with European vehicles.*

Fender Flare Extensions	G2 (except 6x6 models)	715005111*	\$265.99
--------------------------------	------------------------	-------------------	-----------------



- Block terrain debris from kicking up onto you as you ride or damaging your vehicle thanks to these extra-large Fender Flare Extensions, which also include mud flaps for added protection from mud/snow, especially when riding with track kits.
- Made of high molecular weight polyethylene (HMWPE) for advanced abrasion resistance.
- Include front and rear extensions.

**Must be used with Fender Flares for G2 (715001764).*

Fender Flares	G2S (except X mr models)	705012695	\$259.49
----------------------	--------------------------	------------------	-----------------



- Integrated extended Fender Flares for sporty look and full body protection from dirt and water.
- Include front and rear extensions and all mounting hardware.

Flatbed Protection Tubes	G2 (6x6 models only)	715002030	\$553.49
---------------------------------	----------------------	------------------	-----------------



- Bolt-on bumpers for the sides of the 6x6 flatbed.
- Protect the exterior plastic components of the flatbed from rocks, trees and other obstacles when traversing enclosed areas or loading cargo onto the bed.

Flatbed Protection Tubes	G2L (6x6 models only)	715005266	\$383.49
---------------------------------	-----------------------	------------------	-----------------



- Bolt-on bumpers for the sides of the 6x6 flatbed.
- Protect the exterior plastic components of the flatbed from rocks, trees and other obstacles when traversing enclosed areas or loading cargo onto the bed.

LIGHTS & ELECTRICAL

Integrated Heated Grips & Thumb Throttle Combo	G2, G2L, G2S (2024 & up)	715009284	\$359.99
---	--------------------------	------------------	-----------------



- Heat levels for grips and thumb displayed on vehicle screen.
- Ergonomic button integrated on LH grip.
- Single button for both grips and thumb heat selection.*
- Five temperature settings for the thumb and grips.
- Adjustable heat ratio between grip and thumb warmer.*
- Hold button to reach maximum heat quickly.
- Remembers your last heat setting.
- IP67-rated waterproof sealing keeps the elements out.
- ECE compliant.
- Plug-and-play installation.
- Clamp-on grips, no glue required.

* Models with touchscreen display provide enhanced user interface with independent grips and thumb heat level selection.

Heated Grips & Thumb Throttle Combo	G2, G2L, G2S	715003250 Not compatible with Intelligent Throttle Control (ITC)	\$289.99
	G2, G2L, G2S (2019 to 2021)	715008739 Compatible with Intelligent Throttle Control (ITC)	
	G2, G2L, G2S (2022 & up)	715010553 Compatible with Intelligent Throttle Control (ITC)	



- LED dimmer facilitates reading temperature settings.
- 4 temperature settings with individual controls for thumb and grips.
- Returns to previous heat setting.
- One-touch shutdown.
- Wiring Cable is required for installation on G2L models only.

Wiring Cable <i>(Not illustrated)</i>	G2L	710004567	\$12.76
---	-----	------------------	----------------

- Required for installation of Heated Hand Grips and Throttle Combo.

Heated Visor Outlet	G2, G2L	715001246	\$60.99
----------------------------	---------	------------------	----------------



- Strategically positioned on vehicle to maintain your agility.
- Optional visor outlet that delivers fog-free riding.
- Quick and easy installation.
- Sold individually.
- Heated Visor not included.

Heated Passenger Grips & Visor Outlet	G2, G2L (MAX models only)	715008794	\$256.49
	<ul style="list-style-type: none"> • Replace your stock passenger handles. • Dual temperature switch integrated into seat arm for 3-zone heated handles and grips. • Heated visor outlet integrated into seat arm. 		
USB Power Outlet Kit	G2, G2L, G2S	219400510	\$42.99
	<ul style="list-style-type: none"> • Recharges your electronic devices while riding* (smartphone, MP3, heating gear, etc.). • Dual port USB connectors. • Plug-and-play kit. <p><small>* The power outlet is not capable of recharging all device types while riding.</small></p>		
Seat Heater	G2, G2L	715007211	\$139.99
	<ul style="list-style-type: none"> • 25 W seat heater delivers chill-free riding comfort. • One temperature only. • Heated pad and electrical harness only. • Heavy Duty Seat Cover (715007212) is required for the installation. 		
Bluetooth Handlebar Soundbar by MTX	G2, G2L, G2S	219400840	\$523.99
	<ul style="list-style-type: none"> • Bluetooth speaker with the unbeatable convenience of fingertip control. • Rugged IP66-rated weather-resistant speaker designed for outdoor use. • Driven by 150 watts of quality audio power. • Seamless integration and operation from Bluetooth enabled devices. <ul style="list-style-type: none"> • Includes input, ground and ignition wires, plus auxiliary port and 3.5" (8.89 cm) connector cable. • Not compatible with XT Handlebar Protector Kit. • EC compliant. <p><small>Note: We recommend you use 320 kbps MP3, 192-256 kbps AAC or AIFF, WAV formats to match the potential of the speaker. More compressed formats will probably have degraded sound quality.</small></p>		
Electronic Device Holder	G2, G2L (except 6x6 & X mr models)	715004919	\$154.49
	<ul style="list-style-type: none"> • Robust injected-polypropylene construction allows for the right fit and easy installation. • Adjustable unit safely holds smartphones or small tablets with a length or width measuring between 2.9" (7.5 cm) and 5.1" (13.0 cm) with or without protective case. • Integrated storage (0.6 gal / 2.1 L). <ul style="list-style-type: none"> • Guiding wire grooves to pass charging cable through the lid. • Possibility of relocating 12 V power outlet or installing USB outlet in storage compartment (USB power outlet sold separately). • Not compatible with windshields or Snorkel Kit. 		
3.5" (9 cm) LED Lights (2 X 14 W) LED Driving Lights	G2, G2L (except X mr models)	715009775	\$283.49
	<ul style="list-style-type: none"> • 14 W LED lights producing 1,260 lumens each. • Equipped with 6 high power LEDs in a heavy-duty die cast aluminum housing. • Features 2 attachment points — if one attachment point fails due to a collision, rotate to the next channel point and re-mount the light. <ul style="list-style-type: none"> • Sold in pairs. • EC compliant. • Spot lens for a narrow and long light beam spread, ideal when driving at higher speeds. • Expedition Front Bumper (715007233) and Light Power Cable (715007275) required for installation. 		
3.5" (9 cm) LED Flood Lights (2 X 14 W)	G2, G2L (except X mr models)	715009774	\$283.49
	<ul style="list-style-type: none"> • 14 W LED lights producing 1,260 lumens each. • Equipped with 6 high power LEDs in a heavy-duty die cast aluminum housing. • Features 2 attachment points — if one attachment point fails due to a collision, rotate to the next channel point and re-mount the light. <ul style="list-style-type: none"> • Sold in pairs. • EC compliant. • Flood lens for a wide light beam spread, ideal for working applications like plowing or for winding, dusty or foggy riding conditions. • Expedition Front Bumper (715007233) and Light Power Cable (715007275) required for installation. 		
4" (10 cm) Round LED Lights (2 x 25 W)	G2, G2L (except X mr models)	715002935	\$480.99
	<ul style="list-style-type: none"> • 25 W LED spotlights. • 1,800 lumens. • Rugged and waterproof. • Includes basic wiring and switch. • Can-Am branded grill. <ul style="list-style-type: none"> • Sold in pairs. • Not EC compliant. • Expedition Front Bumper (715007233) and Light Power Cable (715007275) required for installation. 		

10" (25 cm) Double Stacked LED Light Bar (60 W)	G2, G2L (except X mr models)	715002933	\$395.49
--	------------------------------	------------------	-----------------



- Equipped with twelve 5 W Cree LEDs.
- 5,400 lumens.
- Packs a big punch for its size.
- Rugged and waterproof.
- Can be installed on front bumpers, sport roof and Bimini roof with sun visor.
- Expedition Front Bumpers (715007233) and Light Power Cable (715007275) required for installation.
- Lights up to more than 1,500 ft (460 m) in front of the vehicle and around 65 ft (20 m) wide on each side.
- EC-compliant.

Light Power Cable <i>(Not illustrated)</i>	G2, G2L	715007275	\$128.49
--	---------	------------------	-----------------

- Required for installation of the 10" (25 cm) LED Light Bar and the 3.5" (9 cm) and 4" (10 cm) LED Lights.

Baja Designs High Beam Kit	G2 (2022 and prior)	715004284	\$769.99
-----------------------------------	---------------------	------------------	-----------------



- Thanks to their direct bolt-on and plug-and-play installation right into the original high beam location, upgrading from your stock high beam lights to these powerful Baja Designs Squadron Pro LED Lights becomes child's play.
- Each spot is equipped with 4 Cree LEDs producing 4,900 lumens at 40 watts.
- Driving/Combo light pattern for smooth blend of light for both near field applications and distance.

2" (5 cm) Square LED Lights (2 X 10 W)	G2, G2L, G2S	715004293	\$219.49
---	--------------	------------------	-----------------



- 2 x 900 lumens 10 W LED Cree light kit.
- Long-range illumination up to 350' (107 m), drawing less than 1 amp per light.
- Multi-Position Light Mount Kit is required for installation.
- Not EC compliant.

Multi Position Light Mount Kit	G2, G2L, G2S	715004274	\$103.49
---------------------------------------	--------------	------------------	-----------------



- Multi-position plastic clamps that fit on various tubing sizes: 0.75" to 1.5" (19 mm to 38 mm).
- Required for the installation of the 2" (5 cm) Square LED Lights (2 x 10 W).
- Kit includes tube clamp mounts and power cables.

RAM[†] LED Spotlight	G2, G2L, G2S	710005423	\$174.99
--------------------------------------	--------------	------------------	-----------------



- 540-lumen (9 W) heavy-duty LED spotlight standard-equipped with 1" (2.5 cm) diameter rubber-coated double ball and socket system.

Quick Connect Cable with Battery Indicator		715006055	\$23.99
---	--	------------------	----------------



- Quickly and easily connect and charge different batteries with your charger.
- 3-color LED indicator provides constant battery health indication.
- Sold individually.

RAM Mount for Cellphone Holder	G2, G2L, G2S	715001985	\$71.99
---------------------------------------	--------------	------------------	----------------



- Convenient bracket for installing the Cellphone Holder (715008786) (not included) onto your unit's handlebar.

Digitally Encoded Security System (D.E.S.S.[™]) Green Key	G2, G2S (2018 & up)	710005232	\$63.49
---	---------------------	------------------	----------------



- Anti-theft technology, Digitally Encoded Security System (D.E.S.S.[™]) key snaps easily on the vehicle and provides riders with easy and quick starts every time.
- The key communicates with the vehicle wirelessly so the vehicle starts only when the key code matches the vehicle, for ultimate peace of mind.
- The Programmable D.E.S.S.[™]. Key can also be programmed in 3 modes:
 - Work mode: Limits vehicle speed to 40 kph (25 mph) but does not limit engine torque.
 - Normal mode: Limits vehicle speed to 70 kph (44 mph) and 50% torque reduction.
 - Performance mode: No restrictions.

WINCHES

CAN-AM HD WINCHES

Can-Am HD 2500 Winch	G2, G2L	715006414	\$331.49
-----------------------------	---------	------------------	-----------------



- Heavy-duty four-way roller fairlead.
- Ergonomic clutch handle.
- Rugged all-steel gears and bushings provide more torque and longer life.
- Automatic 100% load-holding brake.
- Sealed solenoid for all-weather protection.
- Wired Remote Control sold separately.
- Plug-and-play wiring and attachment brackets.
- Weather-sealed handlebar-mounted switch.
- Pulling strength capability of 2,500 lb (1,134 kg).
- 50 ft. of 3/16" (15.2 m of 4.8 mm) wire steel cable.
- EC-compliant.

Can-Am HD 3500 Winch	G2, G2L	715006415	\$373.99
-----------------------------	---------	------------------	-----------------



- Heavy-duty four-way roller fairlead.
- Ergonomic clutch handle.
- Rugged all-steel gears and bushings provide more torque and longer life.
- Automatic 100% load-holding brake.
- Sealed solenoid for all-weather protection.
- Wired Remote Control sold separately.
- Plug-and-play wiring and attachment brackets.
- Weather-sealed handlebar-mounted switch.
- Pulling strength capability of 3,500 lb (1,588 kg).
- 50 ft. of 7/32" (15.2 m of 5.4 mm) wire steel cable.
- EC-compliant.

NEW Can-Am HD 2500 Winch	G2S 2023 & up	715008140	\$384.99
---------------------------------	---------------	------------------	-----------------



- Heavy-duty four-way roller fairlead.
- Ergonomic clutch handle.
- Rugged all-steel gears and bushings provide more torque and longer life.
- Automatic 100% load-holding brake.
- Sealed solenoid for all-weather protection.
- Wired Remote Control sold separately.
- Weather-sealed handlebar-mounted switch.
- EC-compliant.

NEW Can-Am HD 3500 Winch	G2S 2023 & up	715008141	\$416.99
---------------------------------	---------------	------------------	-----------------



- Heavy-duty four-way roller fairlead.
- Ergonomic clutch handle.
- Rugged all-steel gears and bushings provide more torque and longer life.
- Automatic 100% load-holding brake.
- Sealed solenoid for all-weather protection.
- Wired Remote Control sold separately.
- Weather-sealed handlebar-mounted switch.
- EC-compliant.

WINCH ACCESSORIES

Wireless Winch Remote	Can-Am HD Winches	715008286	\$159.74
------------------------------	-------------------	------------------	-----------------



- On/Off and Winch In / Winch Out buttons with LED indicator light.
- Large Winch In / Winch Out buttons for easy activation with gloves.
- Ergonomic remote handle shape with a trigger-like holding protrusion.
- Quick and easy to install, thanks to a wiring harness with an integrated antenna and all necessary mounting hardware.
- Allows you to operate your winch from anywhere within a 50' (15.2 m) radius, increasing your recovery options.
- All components are IP67 sealing rated.
- Dash and handlebar mounting options.
- Compatible with all Can-Am HD winches.

Wired Remote Control	WARN Winches	715006378	\$92.99
	Can-Am HD Winches (715006414 & 715006415)	715006555	\$31.99
	Can-Am HD Winches (715008140 & 715008141)	715008121	\$32.99



- This kit allows owners to add a handheld remote to their winch or stock winch.
- Works with the handlebar-mounted switch.
- Wired Remote and Remote Socket included.
- 10 ft. wire.

Winch Accessories Kit		715002409	\$134.49
------------------------------	--	------------------	-----------------



- Get the most out of your winch.
- Double your pulling power, change your pulling direction and keep your winch in proper working order.
- Includes tree straps, snatch block, shackle and winching gloves.

WARN Hawse Fairlead	WARN Winches	715007698	\$83.99
----------------------------	--------------	------------------	----------------



- Double powder-coated construction.
- Required to use the Synthetic Winch Cable (715004254) on WARN winches.
- To be used with synthetic winch cables only.

Roller Fairlead	WARN Winches	715007699	\$83.99
	Can-Am HD Winch	710007459	\$60.49



- Features top, bottom and side rollers for less cable wear and smoother operation from any direction for easier winching.

Hook with Safety Latch & Strap Kit <i>(Not illustrated)</i>	Can-Am HD Winches	705014949	\$24.99
---	-------------------	------------------	----------------

- Heavy-duty winch-rope hook with stainless steel snap.
- Includes a nylon safety strap.

Replacement Wire Rope – Can-Am HD	705014983	\$23.49
	705014984	\$38.49



- Play it safe, always carry a replacement wire rope.
- 2,500 lb (1,134 kg) pulling strength with 50 ft of 3/16" (15.2 m of 4.8 mm) wire rope for 705014983.
- 3,500 lb (1,588 kg) pulling strength with 50 ft of 7/32" (15.2 m of 5.5 mm) wire rope for 705014984.

Replacement Wire Rope – ATV WARN Winches	715006256	\$78.99
---	------------------	----------------



- Play it safe, always carry a replacement wire rope.
- 3,500 lb (1,588 kg) pulling strength.
- 50 ft. of 7/32" (15.2 m of 5.5 mm) aircraft grade steel wire.

Synthetic Winch Cable	ATV WARN Winches	715004254	\$164.99
------------------------------	------------------	------------------	-----------------



- Easier to manipulate than steel cable.
- Replaces the original cable on any factory installed WARN winch or sold as an accessory by BRP.
- Kit includes synthetic rope and rock guard sleeve.
- Always use with the new Hawse Fairlead (715007698).
- 50 ft. (15.2 m) of 3/16" (15.2 m of 4.8 mm) synthetic rope.
- 3,500 lb (1,588 kg) pulling strength.

Winch Mounting Plate	G2S 2022 & prior	715000927	\$138.49
-----------------------------	------------------	------------------	-----------------



- Adds functionality to your Renegade.
- Fits Can-Am winches by WARN.

Winch Wire Harness <i>(Not illustrated)</i>	G2 2021 & up, G2S 2021 & up and G2L	715002453	\$48.99
---	-------------------------------------	------------------	----------------

- Required plug-and-go wiring to install WARN winch only.
- Not required for Can-Am HD winches.

HITCHES

HITCHES

Rear Hitch	G2, G2L (except 6x6 models), G2S	715001925	\$62.49
-------------------	----------------------------------	------------------	----------------





- E-coat finish.
- Fixed hitch ball mounting bracket.
- Provides fixed mounting point for trailer ball to provide vehicle with towing capabilities.
- This hitch offers 1,300 lb (590 kg) of towing capacity.
- Hitch ball not included.

Front and Rear Hitch Drawbar	G2, G2L, G2S	715008350	\$106.49
-------------------------------------	--------------	------------------	-----------------







- Standard on 2" (5 cm) receiver hitch.
- It offers 1,650 lb (750 kg) of towing capacity.
- Hitch ball not included.
- Forged steel.

HITCH ACCESSORIES

Rear Receiver Hitch	G2S 2012 with 800R or 1000 engines G2S 2013 & up, G2L & G2	715005186	\$128.49
	<ul style="list-style-type: none"> E-coat finish. Does not affect ground clearance. Trailer ball not included. On 4x4 use, this hitch offers 1,500 lb (680 kg) of towing capacity. 	<ul style="list-style-type: none"> On 6x6 use, this hitch offers 1,654 lb (750 kg) of towing capacity. Compliant with European T regulations. Not compatible with G2L models with Rear Skid Plates. 	
Front Receiver Hitch	G2	715000921	\$111.99
	<ul style="list-style-type: none"> Front receiver hitch for Outlander with or without a winch. This hitch offers 1,300 lb (590 kg) of towing capacity. Allows you to maneuver your trailer easily in tight, confined areas. Hitch bar sold separately. Not compatible with Extreme Front Bumper, Rancher Bumper or ProMount Plows. 		
Rubber Receiver Plug		705204503	\$13.81
	<ul style="list-style-type: none"> Rubber cap for 2" (5 cm) hitch receiver. 		

PERFORMANCE

PERFORMANCE

Renegade Snorkel Kit	G2S (2021 & up)	715007083	\$641.99
	<ul style="list-style-type: none"> Comprehensive kit. Extended air intakes and CVT exhaust. CVT outlet integrates into pod cover. Ideal for muddy conditions. 		
Renegade Radiator Relocator Kit	G2S (2023 & up) G2S (2022 & prior)	715008898 715001929	\$513.49 \$502.49
	<ul style="list-style-type: none"> Relocates radiator to top mount position. Prevents cooling performance loss in muddy conditions. Uses existing radiator. Includes support, hardware and hoses. Engineered for easy cooling system bleeding and maintenance. 	<ul style="list-style-type: none"> Radiator not included. Renegade Extreme Front Bumper (715002469) required for G2S 2022 and prior or X mr Front Bumper (715008198) required for 2023 and up for installation (except X mr). 	
Mud Strap	G2, G2L, G2S	715003053	\$50.99
	<ul style="list-style-type: none"> Convenient sturdy grab-handle. Lets drivers redistribute their weight for improved traction in demanding conditions. 		
Radiator Protector	G2, G2S (except G2S with 500 engine)	715001744	\$77.49
	<ul style="list-style-type: none"> Metal shield that mounts over radiator face, providing protection from stones and branches. 		
Outlander Snorkel Kit	G2 2015 & up, G2L (except X mr & 6x6 models)	715005999	\$499.99
	<ul style="list-style-type: none"> Comprehensive kit. Extended air intakes and CVT exhaust. CVT outlet integrates into pod cover. 	<ul style="list-style-type: none"> Must be installed on a vehicle without XT Handlebar Protector Kit. Ideal for muddy conditions. Not compatible with windshields. 	

Outlander Snorkel Kit	G2 (X mr models only), G2L (X mr models only)	715002518	\$122.49
------------------------------	---	------------------	-----------------



- Comprehensive kit.
- Extended air intakes and CVT exhaust.
- CVT outlet integrates into pod cover.
- Must be installed on a vehicle without XT Handlebar Protector Kit.
- Ideal for muddy conditions.
- Not compatible with windshields.
- Raised horn only.
- Provides higher intake.
- For best fit and finish, appropriate gauge support is required.

Outlander Radiator Relocator Kit	G2, G2L (except X xc 2022 & up and 6x6 models)	715001930	\$502.49
---	--	------------------	-----------------



- Relocates radiator to top mount position.
- Prevents cooling performance loss in muddy conditions.
- Uses existing radiator.
- Includes support, hardware and hoses.
- Engineered for easy cooling system bleeding and maintenance.
- Radiator not included.

X mr Traction Plates	G2 (MAX models only), G2L	715001752	\$132.99
-----------------------------	---------------------------	------------------	-----------------



- Provide extra foot grip for driver when riding in extreme mud conditions.
- Help driver maintain ideal riding position to maximize vehicle traction.
- Made of aluminum.
- Not meant for a passenger.

Self-Clearing Footwells	G2 2015 & up, G2L	715004759	\$329.99
--------------------------------	-------------------	------------------	-----------------



- Made from aluminum.
- Replace original footwells.
- Feature large evacuation ports to avoid mud and snow accumulation in footwells.
- Aggressive design for improved traction.
- Not compatible with Body Side Protectors.
- Sold in pairs.

Footpeg Kit	G2, G2L	715001131	\$59.49
--------------------	---------	------------------	----------------



- Provides maximum integrated grip and more stability during vigorous riding.
- Kick-up end generates added grip during hard cornering.
- Made of aluminum.
- Sold in pairs.

Foam Air Filter by Twin Air[®]	G2, G2S, G2L	715001333	\$78.49
--	--------------	------------------	----------------



- Maximizes performance by increasing air flow throughout RPM range.
- Maintenance-friendly, i.e., just wash, re-oil and re-use after riding in severely dusty/muddy environments.

Heavy-Duty Springs	G2 2012-2018 (Base model, DPS, XT, X mr with 650 engine only & Limited – except 6x6) G2S (Base model with 500 & 570 engines only)	715003199 • Front	\$159.49
	G2 2012-2018 (Base model, DPS, XT & X mr with 650 engine only – except 6x6) G2S (Base model with 500 & 570 engines only)	715003200 • Rear	\$159.49
	G2 2019 & up (Base, DPS & XT models, except 6x6)	715005159 • Front & Rear	\$281.99



- Heavy-duty springs provide enhanced stiffness.
- Perfect for snow clearing and hauling heavy loads.
- Improve handling.
- Standard on Outlander PRO and Mossy Oak models.

Front Shock Covers	G2, G2L, G2S	715500301	\$50.99
---------------------------	--------------	------------------	----------------



- Feature ventilation holes.
- Offer added protection in rough terrain and weather conditions.
- Sold in pairs.

EMERGENCY ACCESSORIES

Emergency Kit	715006102	\$170.49
----------------------	------------------	-----------------



- Complete emergency kit provides all essential equipment and supplies to get out of most unfavorable situations powersport enthusiasts may find themselves in.
- Includes jumper cables, air compressor, tire-repair kit, first-aid kit, ratchet tie-down, duct tape, 3,300 lb (1,500 kg) tow strap, zip ties and cloth rags.

COVERS, DECALS & ADD-ONS

Trailer Cover	G2 (except MAX models)	715001737	\$244.99
	G2 (MAX and X mr 1000R models only)	715001736	\$297.99
	G2L (except MAX models)	715002026	\$244.99
	G2L (MAX models only)	715002025	\$303.49



- Heavy-duty canvas made of UV-resistant solution-dyed polyester.
- Protect windshield and colored panels from abrasion.
- All high-abrasion areas are reinforced with a double canvas layer.
- Opening for fuel cap access.
- Weather-resistant trawling cover protects your vehicle during transportation.
- Quick and easy installation.
- Designed to perfectly fit your vehicle with or without Can-Am accessories.

Heavy-Duty Seat Cover	G2, G2L	715007212	\$59.49
------------------------------	---------	------------------	----------------



- Heavy-duty materials to cover and protect the seat.
- Abrasion- and tear-resistant.
- Simply installs by stretching around the original seat; the elastic holds the cover securely in place.

Storage Cover	G2, G2L, G2 X mr (except 1000), G2L X mr, G2S, G2S X mr	715001720	\$234.99
	G2, G2L (MAX and X mr 1000R models only)	715001668	\$239.49



- Weather-resistant storage covers.
- For vehicle storage only.
- UV-resistant solution-dyed polyester construction.
- Quick and easy installation.
- Designed to perfectly fit your vehicle with or without Can-Am accessories.

Flag	 715000277 • Yellow	\$35.99
-------------	---	----------------



- Make sure everyone knows what you're riding.
- Perfect for the dunes and new riders.
- 8-ft. (2.4 m) length.
- Includes Flag Mount (715000127).

Bolt-On[†] Retractable Ratcheting Tie-Downs	295100737	\$30.99
---	------------------	----------------



- Perfect for transporting your powersport vehicle or securing loads.
- Mount easily: bolt on any flat surface (e.g., truck bed or frame).
- 1" x 6' (2.5 cm x 1.8 m) tie-down strap with heavy-duty stitching that delivers a 500 lb (226 kg) working load strength and 1,500 lb (680 kg) break strength.
- Convenient retractable push button automatically slackens, spools and stores away strap, while the ratchet mechanism tightens the strap snugly to secure your vehicle or load into place.
- Rubber ratcheting handle provides firm grip, and the hook is vinyl coated to protect whatever surface it hooks into.
- Sold in pairs.

Ratchet Tie-Downs	 715008309 • Black/Gray	\$31.99
--------------------------	---	----------------



- 400 lb (181 kg) safe working load.
- 1" x 10' (2.5 cm x 3 m) strap with Can-Am, Sea-Doo, and Ski-Doo logos.
- Deluxe ratchet with rubber handle.
- Coated S hooks.
- Pack of 2.

Heavy-Duty Ratchet Tie-Down	715008308	\$47.99
------------------------------------	------------------	----------------



- 1,000 lb (454 kg) safe working load.
- 1.5" x 6' (38 mm x 1.8 m) strap with BRP brands.
- Deluxe ratchet with rubber handle.
- Black-coated clip hooks.
- 12" (300 mm) webbing included.
- Pack of two.

Shifter Lock	G2, G2L	715007337	\$63.99
---------------------	---------	------------------	----------------



- Secure the vehicle's shifter by locking it in position.
- Prevents the vehicle from going into neutral without the lock key.

Lockable Gas Tank Cap	G2, G2L, G2S	860200387	\$58.49
------------------------------	--------------	------------------	----------------



- Protects your fuel.
- Meets EPA requirements.

License Plate Bracket	G2S	715001401	\$25.49
------------------------------	-----	------------------	----------------



- Provides specific area to install license plate.
- Mounts to rear of vehicle.

No traction? No problem. Apache XC Tracks are built for serious terrain. With improved flotation and stability, they tackle deep snow, mud, and everything in between. Engineered for optimized attack angles, reduced noise, and unmatched durability, this system means all-season dominance.

DESIGNED FOR PEAK PERFORMANCE

Aggressive lugs deliver max traction without sacrificing handling. A reinforced steel frame boosts strength, while the center slide improves alignment and reduces de-tracking. Reduced NVH levels and the wheel placement ensure smooth, quiet power delivery. Plus, wheel longevity is increased with replaceable wheel bearings.



APACHE TRACK SYSTEMS

APACHE TRACK SYSTEMS

Apache Backcountry Track System

G2 (except 6x6 models), G2L, G2S

715005247

\$6,749.99



- Designed to deliver the best flotation level and deep-snow performance on the market.
- Contact patch is 23% bigger than the Apache 360 LT.
- Impressive added ground clearance of 7" (18 cm), keeps the vehicle out of deep snow.
- Aggressive track design with 2" (5 cm) lug height for maximum traction on snow.
- Apache Backcountry Mounting Kit and engine and air intake pre-filters are required.
- For winter use only.

Apache Backcountry Mounting Kit

(Not illustrated)

G2 2018 & prior, G2S 2018 & prior, G2L

715004830

G2 2019 & up, G2S 2019 & up

715004796

\$550.49

- Required for installation of the Apache Backcountry Track System.
- DPS module and pre-filter are required and sold separately.

APACHE XC AND XC LT

Apache XC LT Track System

G2 2019 & up, G2S 2019 & up

715007719

\$6,899.99



- Long Track version.
- Brand-new track design to optimize driving off and in deep snow conditions.
- Reduction in steering effort thanks to the tandem 4 wheels.
- Vibrations are reduced due to the alignment of the wheels with the rolling band of the track and the shaft damper mounted tandem.
- Better steering precision with this wheel and track alignment due to good ground contact.
- 1.25" (3.175 cm) lugs in the front and in the back for better traction and lateral stability.
- Track width: front 12.5" and rear 15".
- Adds 3" (7.62 cm) of ground clearance versus 27" tires.
- Additional shaft dampers, tandem dampers, track design and wheel layout significantly reduce NVH (noise vibration harshness).
- Central guide for optimized track alignment and reduced occurrences of detracking.
- Optimized track layout with increased angle of attack for better obstacle crossing and snow performance.
- Stamped and welded steel frame for improved strength and durability.
- Easy maintenance with replaceable hub and wheel bearings.
- Main hub is oil bath with 3 bearings inside for consistent lubrication.
- DPS module and engine and CVT pre-filter required.
- Mounting kit sold separately.

Apache XC Track System

G2 2019 & up, G2S 2019 & up

715008664

\$5,719.99



- Brand-new track design to optimize driving off and in deep snow conditions.
- Reduction in steering effort thanks to the tandem 4 wheels.
- Vibrations are reduced due to the alignment of the wheels with the rolling band of the track and the shaft damper mounted tandem.
- Better steering precision with this wheel and track alignment due to good ground contact.
- 1.25" (3.175 cm) lugs in the front and in the back for better traction and lateral stability.
- Track width: front 12.5" and rear 15".
- Adds 3.25" of ground clearance vs 25" tires.
- Additional shaft dampers, tandem dampers, track design and wheel layout significantly reduce NVH (noise vibration harshness).
- Central guide for optimized track alignment and reduced occurrences of detracking.
- Optimized track layout with increased angle of attack for better obstacle crossing and snow performance.
- Stamped and welded steel frame for improved strength and durability.
- Easy maintenance with replaceable hub and wheel bearings.
- Main hub is oil bath with 3 bearings inside for consistent lubrication.
- DPS module and engine and CVT pre-filter required.
- Mounting kit sold separately.

Apache XC & XC LT Mounting Kit

(Not illustrated)

G2 2019 & up, G2S 2019 & up

715008200

\$377.99

- Required for installation of the Apache XC and XC LT Track System.
- Track DPS Module and Pre-Filter not included.

APACHE 360 & 360 LT

Apache 360 Track System

G2 (except 6x6 models), G2L, G2S

715006323

\$5,459.99



- Multifunctional tracks perfect for any Can-Am ATV.
- Average ground clearance of 16" (41 cm).
- 1" (2.5 cm) lugs in the front and 1.25" (3.2 cm) in the back.
- Apache 360 and 360 LT Mounting Kit and engine and air intake pre-filters are required.
- EC compliant.

Apache 360 LT Track System

G2, G2L, G2S

715005103

\$6,729.99



- Multifunctional tracks designed to support heavy loads and to fit on most Can-Am Off-Road vehicles.
- Extra contact patch adjustment for better performance over rough terrain.
- Contact patch is 7 to 9% bigger than the Apache 360's. Average ground clearance of 16" (41 cm). 1" (2.5 cm) lugs in the front and 1.25" (3.2 cm) in the back.
- EC compliant.
- ATV: Apache 360 and 360 LT Mounting Kit, Track DPS Module and Engine and CVT air intake pre-filters are required and sold separately.

APACHE 360 LT 6X6

Apache 360 LT (6x6) Track System	G2, G2L (6x6 only)	715005104	\$7,489.99
---	--------------------	------------------	-------------------



- Multifunctional tracks designed to support heavy loads and to fit on most Can-Am Off-Road vehicles.
- Front wheel height adjustment provides enhanced attack angle and better performance over rough terrain when raised or increased contact patch for improved flotation when lowered.
- Average ground clearance increase of 4.5" (11.4 cm).
- 1" (2.5 cm) lugs in the front and 1.25" (3.2 cm) in the back.
- Apache 360 LT Mounting Kit, Track DPS Module and Engine and Pre-Filter Kit are required.
- Reliable heavy-duty build.
- EC compliant.
- Exclusively for the Outlander 6x6.
- Recommended for use on snow only.

Apache 360 & 360 LT Mounting Kit <i>(Not illustrated)</i>	G2 2018 & prior (except 6x6 models), G2S 2018 & prior, G2L	715007207	\$323.49
	G2 2019 & up (except 6x6 models), G2S 2019 & up	715007206	\$323.49
	G2 2018 & prior, G2L (6x6 models)	715004991	\$188.99
	G2 2019 & up (6x6 models)	715005105	\$188.99

- Required to install Apache 360 and 360 LT Track Systems.
- DPS module and pre-filter not included.

APACHE TRACK SYSTEM ACCESSORIES

Track DPS Module <i>(Not illustrated)</i>	G2, G2L, G2S	715007338	\$111.49
---	--------------	------------------	-----------------

- An innovative DPS module that ensures speedometer accuracy and optimized steering assist, which make for perfect track control and riding ease.
- Required to install the Apache and Backcountry Track Systems.

Air Intake Pre-Filter		715003483	\$54.99
------------------------------	--	------------------	----------------



- Adds extra protection to your engine in harsh riding conditions.
- Filter blocks particles larger than 0.007" (0.19 mm).
- Easy, tool-less installation.
- Necessary to maintain vehicle warranty when tracks are installed.
- Required to install the Apache and Backcountry Track Systems.
- Standard on Outlander 650, 650 X mr, 850, 1000, 1000R engines and G2L PRO.
- Not compatible with Snorkel Kits.

Engine Air Intake Pre-Filter	G2, G2L, G2S	715004729	\$44.49
-------------------------------------	--------------	------------------	----------------



- Adds extra protection to your engine in harsh riding conditions.
- Filter blocks particles larger than 0.005" (0.13 mm).
- Necessary to maintain vehicle warranty when tracks are installed.

Idler Wheel Kit	Apache Backcountry Track System (rear tracks only)	860201230 • 141 mm	\$62.49
------------------------	---	------------------------------	----------------



- Reduces drag and rolling resistance.
- Includes 2 wheels, brackets and hardware.
- Add up to 2 kits per rear track.
- Can extend slider life in hardened snow conditions.

Sliders with Vespel[®] Inserts	Apache Backcountry Track System	503194815	\$148.49
--	---------------------------------	------------------	-----------------



- Use DuPont Vespel inserts for less friction.
- Longer life.
- Can be cut to desired length.
- 8 needed per vehicle.
- Sold individually.

Rail Ice Scratchers	Apache Backcountry Track System	860201728	\$127.99
----------------------------	---------------------------------	------------------	-----------------



- Provide additional lubrication in hard and icy conditions.
- Rail mounted, small, light.
- Design expands on coil concept to allow reversing without damage.
- Easily stored when not in use.

APACHE TRACK SYSTEMS FITTING GUIDE

APACHE BACKCOUNTRY

Model Year / Model	Track	Track Mount	Track DPS Module	Prefilter without Snorkel	Prefilter with Snorkel
2015 & Up G2L	715005247	715004830	715007338	715004729	715003483 (standard on G2 models and G2L PRO model)
2018 & Prior G2, G2S					
2019 & Up G2, G2S					
2019 & Up G2 1000R	715005247 & 715005891	715004796			

APACHE XC AND XC LT

Model Year / Model	Track	Track Mount	Track DPS Module	Prefilter without Snorkel	Prefilter with Snorkel
2019 & Up G2, G2S	715007719 and 715008664	715008200	715007338	715004729	715003483 (standard on G2 models and G2L PRO model)

APACHE 360 AND APACHE 360 LT

Model Year / Model	Track	Track Mount	Track DPS Module	Prefilter without Snorkel	Prefilter with Snorkel
2015 & Up G2L	715006323 (Apache 360) OR 715005103 (Apache 360 LT)	715007207	715007338	715004729 & 715003483 (standard on G2 models and G2L PRO model)	715004729
2018 & Prior G2, G2S					
2019 & Up G2, G2S		715007206			

APACHE 360 LT 6X6

Model Year / Model	Track	Track Mount	Track DPS Module	Prefilter without Snorkel	Prefilter with Snorkel
2018 & Prior G2 6x6	715005104	715004991	715007338	715004729 & 715003483 (standard on G2 models and G2L PRO model)	715004729
2019 & Up G2L 6x6					
2019 & Up G2 6x6		715005105			

BUILD A KIT THAT WORKS HARD.

Combine a mounting kit, push frame, and blade. Then, customize with accessories like the plow angling kit, blade extensions, or edge markers. Easy to install, engineered to last, and tough enough for brutal winter jobs—this lineup covers every plowing need.



PROMOUNT PLOWS [↗](#)

PROMOUNT PLOW KITS

REFERENCE CHART

	54" Black Steel	60" Black Steel	66" Black Steel	60" Flex2
Plow Kit	715011333	715011334	715011335	715011336
Blade	715004472	715004202	715009881	715004203
Push Frame	715010845	715010845	715010845	715010845
Mounting Plate	715007751	715007751	715007751	715007751

STEEL PLOWS

Can-Am ProMount Steel Plow Kits 54" (137 cm) Blade

G2, G2L, G2S

■ 715011333 - Black

N/A



- These kits include:
 - Can-Am ProMount Steel Blade
 - Push Frame with Quick-Attach System
 - Mounting Plate

Can-Am ProMount Steel Plow Kits 60" (152 cm) Blade

G2, G2L, G2S

■ 715011334 - Black

N/A



- These kits include:
 - Can-Am ProMount Steel Blade
 - Push Frame with Quick-Attach System
 - Mounting Plate

Can-Am ProMount Steel Plow Kits 66" (168 cm) Blade

G2, G2L, G2S

■ 715011335 - Black

N/A



- These kits include:
 - Can-Am ProMount Steel Blade
 - Push Frame with Quick-Attach System
 - Mounting Plate

Can-Am ProMount Steel Blades 54" (137 cm) Blade

Fits ProMount Push Frame

■ 715004472 - Black

\$384.99



- Blades available individually to create your own kit.
- Compatible with Can-Am ProMount Blade accessories to further enhance plow versatility (some plow accessories are not compatible with 54" (137 cm) plows).
- Not compatible with ProMount Drift Cutters, Blade Extensions and Edge Markers.
- Clears 50" (127 cm) when plow is fully angled.
- Blade height of 14.75" (37 cm).

Can-Am ProMount Steel Blades 60" (152 cm) Blade

Fits ProMount Push Frame

■ 715004202 - Black

\$417.49



- Blades available individually to create your own kit.
- Compatible with Can-Am ProMount Blade accessories to further enhance plow versatility.
- Clears 54" (137 cm) when plow is fully angled.
- Blade height of 17" (43 cm).

Can-Am ProMount Steel Blades 66" (168 cm) Blade

Fits ProMount Push Frame

■ 715009881 - Black

\$534.99



- Blades available individually to create your own kit.
- Compatible with Can-Am ProMount Blade accessories to further enhance plow versatility.
- Clears 60" (152 cm) when plow is fully angled.
- Blade height of 17" (43 cm).

Can-Am ProMount Steel Blades 72" (183 cm) Blade

Fits ProMount Push Frame

■ 715009877 - Black

\$609.99



- Now with an improved shoe design for better flotation with an easy and quick tool-free adjustment.
- Plow blade made from 12-gauge steel.
- Replaceable wear blade.
- Large pin designed for easy blade rotation to eliminate snow buildup at pivot point.
- Blade design provides best snow roll-off at any angle.
- Clears 66" (168 cm) when plow is fully angled.
- Blade height of 17" (43 cm). Compatible with Can-Am ProMount Blade accessories to further enhance plow versatility.

CAN-AM ProMount FLEX2 PLOW KIT

Can-Am ProMount Flex2 – 60" (152 cm) Plow Kit	G2, G2L, G2S	■ 715011336	N/A
--	--------------	-------------	-----



- These kits include:
 - Can-Am ProMount Flex2 Blade
 - Push Frame with Quick-Attach System
 - Mounting Plate

Can-Am ProMount Flex2 – 66" (168 cm) Plow Kit	G2, G2L, G2S	■ 715011337 - Black	N/A
--	--------------	---------------------	-----



- This kit includes:
 - Can-Am ProMount Flex2 Blade
 - Push Frame with Quick-Attach System
 - Mounting Plate

ANGLE PLOWS

Can-Am ProMount Angle Blades 60" (152 cm) Steel Oneway State Blade	G2, G2L, G2S	715007261	\$556.49
---	--------------	-----------	----------



- Make the job easier with the right tools, clear long alleys and make the task easier by sending the snow further out of the way.
- Wing end of plow measures 25" (63 cm) high and tapers down to 17" (43 cm).
- One-way "winged" state plow designed to throw snow higher.
- Rubber Flap (715007299) designed to keep snow away from the driver is offered as accessory (sold separately).
- Can-Am branded.

Can-Am ProMount Angle Blades 66" (168 cm) Steel Oneway State Blade	G2, G2L, G2S	715007263	\$619.99
---	--------------	-----------	----------



- Make the job easier with the right tools, clear long alleys and make the task easier by sending the snow further out of the way.
- Wing end of plow measures 25" (63 cm) high and tapers down to 17" (43 cm).
- One-way "winged" state plow designed to throw snow higher.
- Rubber Flap (715007299) designed to keep snow away from the driver is offered as accessory (sold separately).
- Can-Am branded.

Can-Am ProMount Angle Blades 72" (183 cm) Steel Oneway State Blade	G2, G2L, G2S	715009879	\$705.99
---	--------------	-----------	----------



- Now with an improved shoe design for better flotation with an easy and quick tool-free adjustment.
- Make the job easier with the right tools, clear long alleys and make the task easier by sending the snow further out of the way.
- Wing end of plow measures 26" (67 cm) high and tapers down to 17" (43 cm).
- One-way "winged" state plow designed to throw snow higher.
- Rubber Flap (715007299) designed to keep snow away from the driver is offered as accessory (sold separately).
- Can-Am branded.

ProMount One-Way State Blade Rubber Flap <i>(Not illustrated)</i>		715007299	\$128.49
---	--	-----------	----------

- Allows for more efficient snow projections in various snow conditions.

CAN-AM ProMount FLEX2 PLOWS

Can-Am ProMount Flex2 60" (152 cm) Blade	Fits ProMount Push Frame	715004203	\$524.49
---	--------------------------	-----------	----------





- Plow blade made of UHMWPE, flexible and impact absorbing material prevents damaging your plow when accidental impacts occur.
- Replaceable wear blade.
- Large pin designed for easy blade rotation to eliminate snow buildup at pivot point.
- Blade design provides best snow roll-off at any angle.
- Compatible with Can-Am ProMount Blade accessories to further enhance plow versatility.
- Clears 54" (137 cm) when plow is fully angled.
- Blade height of 17" (43 cm).

Can-Am ProMount Flex2 66" (168 cm) Blade	Fits ProMount Push Frame	715009883	\$598.99
	<ul style="list-style-type: none"> • Plow blade made of UHMWPE, flexible and impact absorbing material prevents damaging your plow when accidental impact occurs. • Replaceable wear blade. • Large pin designed for easy blade rotation to eliminate snow buildup at pivot point. 	<ul style="list-style-type: none"> • Blade design provides best snow roll-off at any angle. • Clears 60" (152 cm) when plow is fully angled. • Blade height of 17" (43 cm). • Compatible with Can-Am ProMount Blade accessories to further enhance plow versatility. 	

Can-Am ProMount Flex2 72" (183 cm) Blade	Fits ProMount Push Frame	715009868	\$684.99
	<ul style="list-style-type: none"> • Now with an improved shoe design for better flotation with an easy and quick tool-free adjustment. • Plow blade made of UHMWPE, a flexible and impact absorbing material that prevents damage to your plow when accidental impacts occur. • Replaceable wear blade. • Large pin designed for easy blade rotation to eliminate snow buildup at pivot point. 	<ul style="list-style-type: none"> • Blade design provides best snow roll-off at any angle. • Compatible with Can-Am ProMount Blade accessories to further enhance plow versatility. • Clears 66" (168 cm) when plow is fully angled. 	

CAN-AM ProMount PLOW ACCESSORIES

Can-Am ProMount Push Frame with Quick-Attach System	G2, G2L, G2S	715010845	\$534.99
	<ul style="list-style-type: none"> • Heavy-duty steel tubes designed to withstand the roughest use. • Mid-mount carriage provides ultimate push strength and traction. • Designed for maximum plow lift height. • Features a self aligning quick-attach system, an easy foot release pedal and an ergonomic handle for plow angle adjustment. 	<ul style="list-style-type: none"> • Plow Roller Fairlead and Plow Limit Switch recommended to extend winch cable lifespan. • Can-Am ProMount Mounting Plate required for installation. • Blade swivels left or right, 5 positions. • Large pin designed for easy blade rotation to eliminate dirt and snow buildup at pivot point. 	

Can-Am ProMount Mounting Plate	G2, G2L, G2S	715007751	\$170.99
	<ul style="list-style-type: none"> • Required to install the Can-Am ProMount Push Frame with Quick-Attach System. • Mounting plate precision-designed to stay on year round without compromising ground clearance. • Fits on ATVs with or without Can-Am Skid Plates. • Plow Roller Fairlead included. 		

Can-Am ProMount Push Frame Extension	G2, G2L, G2S	715006257	\$186.99
	<ul style="list-style-type: none"> • 12" (30 cm) push frame extension. • Required when plow is installed with Apache Track System. 		

NEW Can-Am ProMount Plow Angling System	G2, G2L, G2S	715010904	\$659.49
	<ul style="list-style-type: none"> • Improved operation speed for quicker plow angle adjustments. • Converts your plow system into an easy-to-control unit from the driver's seat. • Using one hand to control all plow motions will allow you to easily concentrate and manage your plowing tasks. 	<ul style="list-style-type: none"> • Compatible with ProMount Blade. • Push Frame (715010845) is required. • Push Frame Extension (715006257) is required for installation with the Front Rancher Bumper. • Winch and plow sold separately. • Not compatible with Apache Backcountry LT Track System. 	

NEW Plow Quick Adjust Blade Shoes	ProMount steel & Flex2 Blades 54" & 60" (all years), 66" & 72" (2025 & prior)	715009751	\$106.99
	<ul style="list-style-type: none"> • Zinc-plated steel construction for corrosion resistance. • Easy and quick tool-free adjustment. • Pre-set adjustment for different heights. • Larger shoe diameter for greater ground contact. • Improved shoe design for better flotation. 		

Can-Am ProMount Edge Markers	G2, G2L, G2S	715004206	\$48.99
	<ul style="list-style-type: none"> • Help locate the edges of your plow. • Height: 24" (60 cm). • Sold in pairs. • Compatible with Can-Am ProMount Steel and Flex2 Blades with or without Blade Extensions (except for the Can-Am ProMount Steel 54" (137 cm) Blades). 		

Can-Am ProMount Drift Cutters	G2, G2L, G2S	715006258	\$170.99
--------------------------------------	--------------	------------------	-----------------



- Help keep snow in the plow.
- Dimensions: 17" x 13" (43.2 cm x 33 cm).
- Sold in pairs.
- Compatible with Can-Am ProMount Steel and Flex2 Blades with or without Blade Extensions (except for the Can-Am ProMount Steel 54" (137 cm) Blades).

Can-Am ProMount Curved Wear Blade	G2, G2L, G2S	715007791 • 60" (152 cm) 715007792 • 66" (168 cm)	\$122.99
--	--------------	--	-----------------



- Wear blade designed with a folded back bottom lip.
- The increased surface allows for less digging while plowing uneven surfaces.
- Ideal for snow covered gravel, grass, paver stone and other soft surfaces.

Can-Am ProMount Plastic Wear Blade	G2, G2L, G2S	715004480 • 54" (137 cm)	\$149.99
		715004481 • 60" (152 cm)	\$170.99
		715004482 • 66" (168 cm)	\$192.49
		715004483 • 72" (183 cm)	\$213.99



- To help prevent scratches on smooth driveways and markable surfaces.

Back Drag Blade	ProMount Plows (60" and more)	715007794	\$299.49
------------------------	-------------------------------	------------------	-----------------



- ¼ thick steel swivel scraper.
- Lifts up when the vehicle is moving forward so as to not affect the scraping.
- Increased capacity to pull snow.
- More aggressive scraping in reverse mode.
- Lifts the blade off the ground so that it scrapes evenly.
- Adjustable in length for compatibility with 60", 66" and 72" blades.
- Compatible with ProMount blades (Flex and Steel).

Plow Roller Fairlead	G2, G2L, G2S	705009222	\$74.49
-----------------------------	--------------	------------------	----------------



- Larger diameter lower roller reduces wear on wire rope for plow application.
- Can be used with all ProMount plows.
- Included in Plow Mounting Plate Kit (715007751).

Pulley Kit for Alpine Super-Duty Plow	G2, G2L	715000279	\$61.99
--	---------	------------------	----------------



- Pulley kit to be used in conjunction with the winch when using a snow plow.
- Recommended to increase winch efficiency.
- To be used with the XT Front Bumper.

Synthetic Winch Cable for Plowing		715000540	\$47.99
--	--	------------------	----------------



- Specially designed for plowing applications.
- 8' (2.4 m) section of durable, extra-strong synthetic rope.
- Stands up to repeated, sharp angle pulls used to lift heavy plow blades.
- Temporarily replace your winch rope for plow season to save wear and tear on wire rope.

Plow Limit Switch <i>(Not illustrated)</i>	G2, G2L, G2S	715006259	\$144.49
--	--------------	------------------	-----------------

- For controlling the cable tension when over-raising your plow system.
- Prevents winch, plow push frame and vehicle damage.

G3, G3L ACCESSORIES



G3, G3L ACCESSORIES

LinQ Accessories:	
Easy On, Easy Off Cargo	58
Cargo & Storage	69
Windshields	71
Handlebars & Mirrors	72
Skid Plates	74
Bumpers & Guards	76
Lights & Electrical	77
Winches	80
Hitches	82
Performance	82
Covers & Add-Ons	84
Apache Track Systems	85
ProMount Plows	88





LINQ SYSTEM

Your ATV is your workhorse and your ticket to adventure. Unlock its full potential with the LinQ system. Easily secure and unload your gear: no fuss, no tools, just ride.

A NEW WAY TO LOCK IN

LinQ SLIDING BASE

Available for the 2026 Outlander 6x6, the new Sliding LinQ Base features a two-part design: a low-profile mount plate stays out of the way, while the sliding base clips in instantly when you need it.

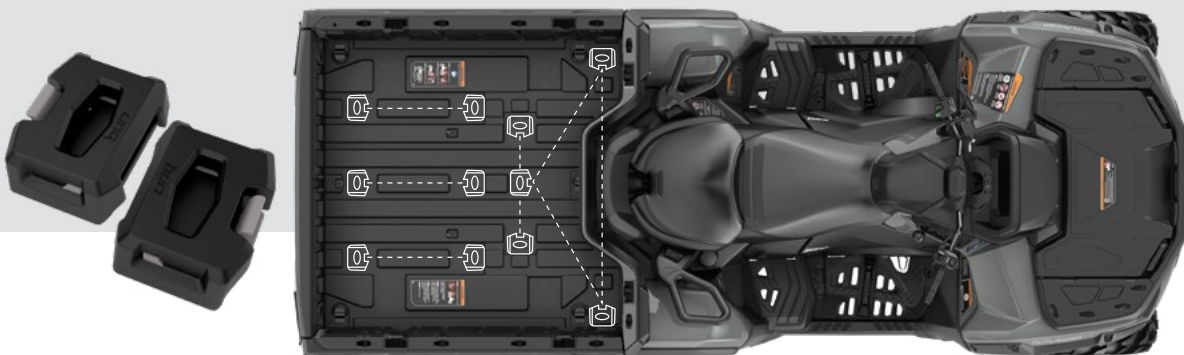

LinQ SYSTEM

fits medium to heavy accessories with two base sizes: 16" bases for standard mounts and 36" bases that unlock optimal load capacity.

LinQ LITE

is designed for compact, on-the-go storage (max. 4.5 lb (2 kg) per latch). It lets you mount accessories to rails or vertical surfaces.

LINQ ACCESSORIES: EASY ON, EASY OFF CARGO



- No tools needed: Quickly install and remove accessories by hand.
- Equip your Can-Am vehicle for specialized tasks in no time.
- Sturdy mounting system that holds up to the roughest terrain.



G3

LinQ ACCESSORIES WITH 16" BASE	1 Front Cargo Compartment	2 Front Rack	3 Rear Cargo Compartment	4 Rear Rack	LinQ Can Stack on Top
NEW LinQ Rigid Cooler (18 L) 715010491	YES, with LinQ Base Installation Kit 860201806 Must be installed inside* the front cargo compartment.	NO	YES, with LinQ Base Installation Kit 860201806	NO	NO
LinQ Tool Box 715008111	YES, with LinQ Base Installation Kit 860201806 Can be installed inside* or on the front cargo compartment.				
LinQ SR 5.5 Gal (21 L) Bag 860202449	YES, with LinQ Base Installation Kit 860201806 Must be installed on the front cargo compartment lid only.				
LinQ 4.5 Gal (17 L) Sport Bag 860202447					
NEW LinQ 5.3 Gal (20 L) Semi-Rigid Cooler 295101252					
LinQ 2.6 Gal (10 L) Modular Cargo Box 715005494	YES, with LinQ Base Installation Kit 860201806 Can be installed inside* or on the front cargo compartment.				
LinQ 5 Gal (20 L) Modular Cargo Box 715007112					
LinQ 7.8 Gal (30 L) Modular Cargo Box 715006830					
LinQ Tool Kit 715006829					
LinQ 10.6 Gal (40 L) Roll-Top Bag 715008110	YES, with LinQ Base Installation Kit 860201806 Must be installed on the front cargo compartment lid only.				
LinQ Fuel Caddy - 4 Gallons 860202246	YES, with LinQ Base Installation Kit 860201806 Must be installed inside* the front cargo compartment only.	NO	NO	NO	
LinQ Oil Caddy - 1 Gallon 860202445					
LinQ Gun Case 715009240	YES, with LinQ Base Installation Kit 860201806 Must be installed on the front cargo compartment lid.				
LinQ ACCESSORIES WITH 36" BASE	Front Cargo Compartment	Front Rack	Rear Cargo Compartment	Rear Rack	LinQ Can Stack on Top
LinQ Cargo Basket (90 L) 715010173	NO	YES	NO	YES	NO
Front LinQ Cargo Box (90 L) 715005272	YES			NO	
LinQ Cargo Box (53 L) 715010172	NO	NO	YES, remove the rear rack for installation.	YES	YES
LinQ Low Profile Box (63 L) 715007827					
LinQ Trunk Box (145 L) 715009471					
LinQ Trunk Box (87 L) - G3 715009499		NO		YES	NO
LinQ 9.2 Gal (35 L) Cooler 715006998			NO		
LinQ Gun Case 715009240		YES		NO	
LinQ HOLDERS AND RACKS	Front Cargo Compartment	Front Rack	Rear Cargo Compartment	Rear Rack	LinQ Can Stack on Top
LinQ Gear Grips 715005340	YES, with LinQ Base Installation Kit 860201806	YES	YES, with LinQ Base Installation Kit 860201806	YES	NO
LinQ Tool Holder 715007358					
LinQ Chainsaw Holder 715004975	YES	NO	NO	NO	NO
LinQ Front Rack Extension 715009281	NO	YES			
LinQ Rear Rack Extension 715009475		NO			

*Removal of front cargo compartment lid is required.

LINQ ACCESSORIES: EASY ON, EASY OFF CARGO



- No tools needed: Quickly install and remove accessories by hand.
- Equip your Can-Am vehicle for specialized tasks in no time.
- Sturdy mounting system that holds up to the roughest terrain.



G3L

	1 Front Cargo Compartment	2 Front Rack	3 Rear Cargo Compartment	4 Rear Rack	LinQ Can Stack on Top		
LinQ ACCESSORIES WITH 16" BASE							
NEW LinQ Rigid Cooler (18 L) 715010491	YES, with LinQ Base Installation Kit 860201806 Must be installed inside* the front cargo compartment.	NO	YES, with LinQ Base Installation Kit 860201806	NO	NO		
LinQ Tool Box 715008111	YES, with LinQ Base Installation Kit 860201806 Can be installed inside* or on the front cargo compartment.						
LinQ SR 5.5 Gal (21 L) Bag 860202449	YES, with LinQ Base Installation Kit 860201806 Must be installed on the front cargo compartment lid only.						
LinQ 4.5 Gal (17 L) Sport Bag 860202447	YES, with LinQ Base Installation Kit 860201806 Can be installed inside* or on the front cargo compartment.						
NEW LinQ 5.3 Gal (20 L) Semi-Rigid Cooler 295101252							
LinQ 2.6 Gal (10 L) Modular Cargo Box 715005494							
LinQ 5 Gal (20 L) Modular Cargo Box 715007112							
LinQ 7.8 Gal (30 L) Modular Cargo Box 715006830							
LinQ Tool Kit 715006829							
LinQ 10.6 Gal (40 L) Roll-Top Bag 715008110						YES, with LinQ Base Installation Kit 860201806 Must be installed on the front cargo compartment lid only.	
LinQ Fuel Caddy - 4 Gallons 860202246	YES, with LinQ Base Installation Kit 860201806 Must be installed inside* the front cargo compartment only.					NO	NO
LinQ Oil Caddy - 1 Gallon 860202445							
LinQ Gun Case 715009240	YES, with LinQ Base Installation Kit 860201806 Must be installed on the front cargo compartment lid.						
LinQ ACCESSORIES WITH 36" BASE							
LinQ Large Cargo Box 715007001	NO	NO	NO	YES	NO		
LinQ Cargo Basket (90 L) 715005274							
LinQ Cargo Box (53 L) 715006997		YES			NO	YES	
LinQ Low Profile Box (63 L) 715007827		YES			NO	NO	NO
LinQ Cargo Box (90 L) 715005272						YES	
LinQ Trunk Box (87 L) - G3L 715009312	NO	NO	YES, remove the rear rack for installation.	NO	YES		
LinQ Trunk Box (145 L) 715009471							
LinQ 9.2 Gal (35 L) Cooler 715006998				YES	NO	YES	NO
LinQ Gun Case 715009240				NO			
LinQ HOLDERS AND RACKS							
LinQ Gear Grips 715005340	YES, with LinQ Base Installation Kit 860201806	YES	YES, with LinQ Base Installation Kit 860201806	YES	NO		
LinQ Tool Holder 715007358							
LinQ Rack Extension 715004954	NO	NO	NO	NO	NO		
LinQ Chainsaw Holder 715004975	YES						

*Removal of front cargo compartment lid is required.

LINQ ACCESSORIES: EASY ON, EASY OFF CARGO



- No tools needed: Quickly install and remove accessories by hand.
- Equip your Can-Am vehicle for specialized tasks in no time.
- Sturdy mounting system that holds up to the roughest terrain.



G3 MAX

	1 Front Cargo Compartment	2 Front Rack	3 Rear Cargo Compartment	4 Rear Rack	LinQ Can Stack on Top
LinQ ACCESSORIES WITH 16" BASE					
NEW LinQ Rigid Cooler (18 L) 715010491	YES, with LinQ Base Installation Kit 860201806 Must be installed inside* the front cargo compartment.				
LinQ Tool Box 715008111	YES, with LinQ Base Installation Kit 860201806 Must be installed on the front cargo compartment lid only.		NO		NO
LinQ SR 5.5 Gal (21 L) Bag 860202449					
LinQ 4.5 Gal (17 L) Sport Bag 860202447			YES, with LinQ Base Installation Kit 860201806		
NEW LinQ 5.3 Gal (20 L) Semi-Rigid Cooler 295101252	YES, with LinQ Base Installation Kit 860201806 Can be installed inside* or on the front cargo compartment.				
LinQ 2.6 Gal (10 L) Modular Cargo Box 715005494		NO		NO	YES
LinQ 5 Gal (20 L) Modular Cargo Box 715007112					NO
LinQ 7.8 Gal (30 L) Modular Cargo Box 715006830					YES
LinQ Tool Kit 715006829			NO		
LinQ 10.6 Gal (40 L) Roll-Top Bag 715008110	YES, with LinQ Base Installation Kit 860201806 Must be installed on the front cargo compartment lid only.				
LinQ Fuel Caddy - 4 Gallons 860202246	YES, with LinQ Base Installation Kit 860201806 Must be installed inside* the front cargo compartment only.				NO
LinQ Oil Caddy - 1 Gallon 860202445					
LinQ Gun Case 715009240	YES, with LinQ Base Installation Kit 860201806 Must be installed on the front cargo compartment lid.				
LinQ ACCESSORIES WITH 36" BASE					
	Front Cargo Compartment	Front Rack	Rear Cargo Compartment	Rear Rack	LinQ Can Stack on Top
LinQ Cargo Basket (90 L) 715010173	NO			YES	NO
Front LinQ Cargo Box (90 L) 715005272	YES	YES	NO	NO	
LinQ Cargo Box (53 L) 715010172	NO			YES	YES
LinQ Low Profile Box (63 L) 715007827				NO	NO
LinQ Trunk Box (139 L) 715009472			NO	YES, remove the rear rack for installation.	
LinQ Trunk Box (87 L) - G3 715009499			NO	NO	YES
LinQ 9.2 Gal (35 L) Cooler 715006998				NO	
LinQ Gun Case 715009240		YES		NO	
LinQ HOLDERS AND RACKS					
	Front Cargo Compartment	Front Rack	Rear Cargo Compartment	Rear Rack	LinQ Can Stack on Top
LinQ Gear Grips 715005340	YES, with LinQ Base Installation Kit 860201806	YES	YES, with LinQ Base Installation Kit 860201806	YES	NO
LinQ Tool Holder 715007358					
LinQ Chainsaw Holder 715004975	YES	NO		NO	NO
LinQ Front Rack Extension 715009281	NO	YES	NO	NO	NO
LinQ Rear Rack Extension 715009475		NO		YES	

*Removal of front cargo compartment lid is required.

LINQ ACCESSORIES: EASY ON, EASY OFF CARGO



- No tools needed: Quickly install and remove accessories by hand.
- Equip your Can-Am vehicle for specialized tasks in no time.
- Sturdy mounting system that holds up to the roughest terrain.



G3L MAX

	1 Front Cargo Compartment	2 Front Rack	3 Rear Cargo Compartment	4 Rear Rack	LinQ Can Stack on Top				
LinQ ACCESSORIES WITH 16" BASE									
NEW LinQ Rigid Cooler (18 L) 715010491	YES, with LinQ Base Installation Kit 860201806 Must be installed inside* the front cargo compartment.	NO	NO	NO	NO				
LinQ Tool Box 715008111	YES, with LinQ Base Installation Kit 860201806 Must be installed on the front cargo compartment lid only.								
LinQ SR 5.5 Gal (21 L) Bag 860202449									
LinQ 4.5 Gal (17 L) Sport Bag 860202447	YES, with LinQ Base Installation Kit 860201806 Can be installed inside* or on the front cargo compartment.					NO	YES, with LinQ Base Installation Kit 860201806	NO	NO
NEW LinQ 5.3 Gal (20 L) Semi-Rigid Cooler 295101252									
LinQ 2.6 Gal (10 L) Modular Cargo Box 715005494									
LinQ 5 Gal (20 L) Modular Cargo Box 715007112									
LinQ 7.8 Gal (30 L) Modular Cargo Box 715006830									
LinQ Tool Kit 715006829									
LinQ 10.6 Gal (40 L) Roll-Top Bag 715008110									
LinQ Fuel Caddy - 4 Gallons 860202246									
LinQ Oil Caddy - 1 Gallon 860202445									
LinQ Gun Case 715009240									
LinQ ACCESSORIES WITH 36" BASE									
LinQ Large Cargo Box 715007001	NO	NO	NO	YES	NO				
LinQ Cargo Basket (90 L) 715005274	YES	YES		NO		NO			
LinQ Cargo Box (90L) 715005272									
LinQ Trunk Box (87 L) - G3L 715009312	NO	NO		NO		YES	YES		
LinQ Cargo Box (53 L) 715006997									
LinQ Low Profile Box (63 L) 715007827									
LinQ Trunk Box (139 L) 715009472									
LinQ 9.2 Gal (35 L) Cooler 715006998									
LinQ Gun Case 715009240									
LinQ Large Cargo Box 715007001		NO				NO		YES, remove the rear rack for installation.	NO
LinQ Cargo Basket (90 L) 715005274	YES	NO		YES		YES			
LinQ Cargo Box (90L) 715005272									
LinQ Trunk Box (87 L) - G3L 715009312									
LinQ Cargo Box (53 L) 715006997	YES	NO	NO	NO	NO				
LinQ Low Profile Box (63 L) 715007827									
LinQ Trunk Box (139 L) 715009472	NO	NO	YES, remove the rear rack for installation.	NO	NO				
LinQ 9.2 Gal (35 L) Cooler 715006998									
LinQ Gun Case 715009240	YES	YES	NO	NO	NO				
LinQ Large Cargo Box 715007001	NO	NO	YES, with LinQ Base Installation Kit 860201806	YES					
LinQ Cargo Basket (90 L) 715005274	YES, with LinQ Base Installation Kit 860201806	YES	NO	NO	NO				
LinQ Cargo Box (90L) 715005272									
LinQ Trunk Box (87 L) - G3L 715009312									
LinQ Cargo Box (53 L) 715006997									
LinQ Low Profile Box (63 L) 715007827	NO	NO	YES, with LinQ Base Installation Kit 860201806	YES	NO				
LinQ Trunk Box (139 L) 715009472									
LinQ 9.2 Gal (35 L) Cooler 715006998									
LinQ Gun Case 715009240									
LinQ HOLDERS AND RACKS									
LinQ Gear Grips 715005340	YES, with LinQ Base Installation Kit 860201806	YES	YES, with LinQ Base Installation Kit 860201806	YES	NO				
LinQ Tool Holder 715007358									
LinQ Rack Extension 715004954									
LinQ Chainsaw Holder 715004975									
LinQ Rack Extension 715004954	NO	NO	NO	NO	NO				
LinQ Chainsaw Holder 715004975	YES	NO	NO	NO					

*Removal of front cargo compartment lid is required.

LINQ ACCESSORIES: EASY ON, EASY OFF CARGO



- No tools needed: Quickly install and remove accessories by hand.
- Equip your Can-Am vehicle for specialized tasks in no time.
- Sturdy mounting system that holds up to the roughest terrain.



6X6

LinQ ACCESSORIES WITH 16" BASE	1 Front Cargo Compartment	2 Front Rack	3 Rear Cargo Bed	LinQ Can Stack on Top			
NEW LinQ Rigid Cooler (18 L) 715010491	YES, with LinQ Base Installation Kit 860201806 Must be installed inside* the front cargo compartment.	NO	YES, with LinQ Sliding Base Installation Kit 715009123	NO			
LinQ Tool Box 715008111	YES, with LinQ Base Installation Kit 860201806 Must be installed on the front cargo compartment lid only.						
LinQ SR 5.5 Gal (21 L) Bag 860202449							
LinQ 4.5 Gal (17 L) Sport Bag 860202447							
LinQ 2.6 Gal (10 L) Modular Cargo Box 715005494	YES, with LinQ Base Installation Kit 860201806 Can be installed inside* or on the front cargo compartment.				NO	YES, with LinQ Sliding Base Installation Kit 715009123	YES
LinQ 5 Gal (20 L) Modular Cargo Box 715007112							
LinQ 7.8 Gal (30 L) Modular Cargo Box 715006830							NO
LinQ Tool Kit 715006829							YES
LinQ 10.6 Gal (40 L) Roll-Top Bag 715008110	YES, with LinQ Base Installation Kit 860201806 Must be installed on the front cargo compartment lid only.				NO	Yes, with LinQ Sliding Base Installation Kit 715009123 . Must be installed under the LinQ Cargo Bed Rack (715009336).	NO
NEW LinQ Fuel Caddy 5 Gallons 715007822	NO						
LinQ Fuel Caddy - 4 Gallons 860202246	YES, with LinQ Base Installation Kit 860201806 Must be installed inside* the front cargo compartment only.						
LinQ Oil Caddy - 1 Gallon 860202445							
LinQ Gun Case 715004968	YES, with LinQ Base Installation Kit 860201806 Must be installed on the front cargo compartment lid.	NO					
LinQ ACCESSORIES WITH 36" BASE	Front Cargo Compartment	Front Rack	Rear Cargo Compartment	LinQ Can Stack on Top			
LinQ Cargo Basket (90 L) 715005274 or 715010173	NO	YES	Yes, with 2x LinQ Sliding Base Installation Kit 715009123 (only when the walls of the bed are removed)** or with the LinQ Cargo Bed Rack (715009336).	NO			
Front LinQ Cargo Box (90 L) 715005272	YES			YES			
LinQ Cargo Box (53 L) 715006997 or 715010172	NO			NO	NO	YES	
LinQ Low Profile Box (63 L) 715007827							
LinQ Trunk Box (87 L) 715009499 or 715009312							
LinQ 9.2 Gal (35 L) Cooler 715006998							
LinQ Gun Case 715004968	YES, with LinQ Base Installation Kit 860201806 Must be installed on the front cargo compartment lid.	YES	NO	NO			
LinQ HOLDERS AND RACKS	Front Cargo Compartment	Front Rack	Rear Cargo Compartment	LinQ Can Stack on Top			
LinQ Gear Grips 715005340	YES, with LinQ Base Installation Kit 860201806	YES	YES, with LinQ Sliding Base Installation Kit 715009123 or on rear bed box walls	NO			
LinQ Tool Holder 715007358							
NEW LinQ Cargo Bed Rack 715009336	NO	NO	YES	YES			
LinQ Chainsaw Holder 715004975	YES	NO	NO	NO			

*Removal of front cargo compartment lid is required.

**LinQ Low Profile (63 L) (715007827) is not compatible with Outlander 6x6 MAX. Can be installed in a 16" configuration only at the rear end of the cargo bed.

LinQ ACCESSORIES WITH 16" BASE

NEW LinQ Rigid Cooler (18 L)	G3, G3L	715010491	\$394.04
-------------------------------------	---------	------------------	-----------------



- Versatile LinQ 16" configuration fits many vehicles.
- Durable rotomolded rigid construction.
- Molded-in handles for quick installation and removal.
- High quality insulation for optimal ice retention.
- Sealed lid for airtight, weather-tight closure.
- Ergonomic and secure latch system offers excellent sealing.
- 4.7 US gal (18 L) capacity.

NEW LinQ 5 US Gal (20 L) Fuel Caddy	G3 (6X6 models only) G3L (6X6 models only)	715007822	\$212.99
--	---	------------------	-----------------



- Quick, easy and secure LinQ system installation.
- Spill-free spout for easy use.
- 5 US gal (20 L) capacity.
- Meets new Flame Mitigation Device (FMD) standard.
- Dimensions: 12" L x 19" W x 12" H.
- Compatible only if installed below the LinQ Cargo Bed Rack (715009336).

LinQ Fuel Caddy – 4 Gallons	G3 (except X mr models) G3L (except X mr models)	860202246	\$255.49
------------------------------------	---	------------------	-----------------



- Quick, easy and secure installation with LinQ system.
- No-spill spout for easy use.
- 3.7 US gallon (14 L) capacity.
- Meets the new latest Flame Mitigation Device (FMD) standard.
- No LinQ 16" accessories can be stacked on the LinQ 4-Gallon Fuel Caddy.
- Can't be installed on the rear lid due to weight limitation.
- See table for installation location and requirements.

LinQ Oil Caddy – 1 Gallon	G3 (except X mr models) G3L (except X mr models)	860202445	\$148.99
----------------------------------	---	------------------	-----------------



- 1 US gallon (3.78 L) capacity.
- No LinQ 16" accessories can be stacked on the LinQ 1-Gallon Oil Caddy.
- Can't be installed on the rear lid due to weight limitation.
- See table for installation location and requirements.

LinQ Chainsaw Holder	G3 (except X mr models) G3L (except X mr models)	715004975	\$191.49
-----------------------------	---	------------------	-----------------



- This system installs a chainsaw vertically to save space on the rack and serves as a scabbard for storage.
- Pinch the blade for a solid and quick fix.
- Compatible with the majority of chainsaws available on the market as most blades go up to 18".
- Compatible with all 16" LinQ accessories that fit in the front cargo compartment.
- Allows installation of the LinQ Tool Holder.
- Not compatible with the LinQ Rack Extension when installed on the front rack of the vehicle.

LinQ Modular Box	G3, G3L	715005494 • (10 L)	\$148.99
		715007112 • (20 L)	\$170.49
		715006830 • (30 L)	\$191.49





- Allows stacking of other modular boxes to always have the right gear accessible.
- Always have the right box size to fit everything.
- Can be installed on any LinQ Base with a 16" width.
- See table for installation location and requirements.
- Can't be installed on the rear lid due to weight limitation.

Thermal Insert for LinQ Modular Box (10 L)	G3, G3L	219401110	\$63.99
---	---------	------------------	----------------





- Insulated liner.
- Fits very well in the LinQ Modular Box (10 L).
- Can contain seven 355 ml cans.
- Keeps ice cold for one day.
- Interior dimensions: 9" L x 17" W x 2½" H.

LinQ Tool Kit	G3, G3L	715006829	\$352.99
	<ul style="list-style-type: none"> Includes: <ul style="list-style-type: none"> - Cutter pliers - Long-nose pliers - Locking pliers - Ratchet wrench 3/8" drive - 6" ratchet extension - Integrated CVT belt storage location (belt not included) 	<ul style="list-style-type: none"> - Long-socket 19 mm 3/8" drive - 6 pts - Socket 18 mm 3/8" drive - Long-socket 17 mm 3/8" drive - 6 pts - Socket 15 mm 3/8" drive - Socket 13 mm 3/8" drive - Socket 10 mm 3/8" drive - Socket 8 mm 3/8" drive 	<ul style="list-style-type: none"> - Socket Torx T40 3/8" drive - Socket Torx T30 3/8" drive - Socket Torx T20 3/8" drive - Breaker bar 3/8" drive - Combination Wrench set: <ul style="list-style-type: none"> - Wrench 19 mm - Wrench 18 mm - Wrench 15 mm - Wrench 13 mm - Wrench 10 mm - Wrench 8 mm <ul style="list-style-type: none"> • See table for installation location and requirements.

LinQ Tool Box	G3, G3L	715008111	\$191.49
	<ul style="list-style-type: none"> • High precision injected HDPE construction provides rigidity and durability. • 5 gal (19 L) maximum capacity. • Weather-resistant, sealed and lockable cover. • Easy one-second on/off tool-less system. All the benefits of LinQ – simple, fast and secure. • See table for installation location and requirements. 		

LinQ 10.6 Gal (40 L) Roll-Top Bag	G3, G3L	715008110	\$244.99
	<ul style="list-style-type: none"> • Fully waterproof roll-top dry bag will securely store and confine your equipment. • LinQ mounted using heavy-duty rigid plastic base. • High capacity storage solution 10.6 gal (40 L). • Bottom foam liner for additional equipment protection. 	<ul style="list-style-type: none"> • Integrated handle for easy transportation on/off the vehicle. • Marineized for salt water purposes. • Dimensions: 14" L x 19" W x adjustable H. • See table for installation location and requirements. 	

SR 5.5 Gal (21 L) LinQ Bag	G3, G3L	860202449	\$244.99
	<ul style="list-style-type: none"> • Semi-rigid expandable bag. • 5.5 gal (21 L) capacity. • See table for installation location and requirements. 		

LinQ 4.5 Gal (17 L) Sport Bag	G3, G3L	860202447	\$223.49
	<ul style="list-style-type: none"> • All the benefits of LinQ – simple, fast and secure. • 17 liter (4.5 US gallon) capacity. • Thermoformed bag base in HDPE (High Density Polyethylene) providing rigidity and durability. 	<ul style="list-style-type: none"> • Rigid bottom, semi-rigid top. • Easy one-second on/off tool-less system. • See table for installation location and requirements. 	

NEW LinQ 5.3 US Gal (20 L) Semi-Rigid Cooler	G3, G3L	295101252	\$265.99
	<ul style="list-style-type: none"> • 5.3 US gal (20 L) of insulated, water-resistant capacity. • Quick, easy and secure LinQ system installation. • Attaches with one set of LinQ Fasteners. • Single day use soft cooler. • Mesh pocket on top of the lid. • Zippered pocket under the lid for quick and easy access. 	<ul style="list-style-type: none"> • Removable interior for easy cleaning. • Carry handles for easy transport. • Can contain twelve 355 ml cans. • Dimensions: 19" L x 13" W x 10" H. • See table for installation location and requirements. 	

LinQ ACCESSORIES WITH 36" BASE

LinQ Trunk Box (145 L)	G3 (except MAX & 6X6 models) G3L (except MAX & 6X6 models)	715009471	\$684.99
	<ul style="list-style-type: none"> • Polyethylene Trunk Box replacing the rear rack for perfect integration and to increase cargo capacity. • Storage capacity of 31 gal (145 L). • Easy to install and remove with the LinQ system. • LinQ anchors must be installed in the rear cargo compartment (4 LinQ anchors included). • Possibility to install LinQ 16" accessories on the cover to increase the cargo capacity. 	<ul style="list-style-type: none"> • New ergonomic and resistant latch system offers excellent sealing. • Ability to install LinQ Tool Holders (715008896) on the box. • Lockable with a lock on the front of the box (two keys included). • See table for installation location and requirements. 	

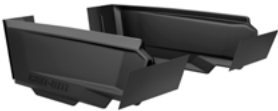
NEW Rear Cargo Box Divider (145 L)	G3 (except MAX & 6X6 models) G3L (except MAX & 6X6 models)	715010103	\$64.19
	<ul style="list-style-type: none"> • Easy installation thanks to hook-and-loop fasteners. • Includes left and right divider. • Measures 7" (176 mm). • It is installed at a specific point in the cargo box to divide it neatly into 3 similar sections. • Requires LinQ 31 US Gal (145 L) Trunk Box (715009471). 		

LinQ Trunk Box (139 L)	G3 (MAX & 6X6 models only) G3L (MAX & 6X6 models only)	715009472	\$684.99
	<ul style="list-style-type: none"> • Polyethylene Trunk Box replacing the rear rack for perfect integration and to increase cargo capacity. • Storage capacity of 30 gal (139 L). • Easy to install and remove with the LinQ system. • LinQ anchors must be installed in the rear cargo compartment (4 LinQ anchors included). • Compatible with the passenger seat. • New ergonomic and resistant latch system offers excellent sealing. • Ability to install LinQ Tool Holders (715008896) on the box. • Lockable with a lock on the front of the box (two keys included). • See table for installation location and requirements. 		
NEW Rear Cargo Box Divider (139 L)	G3 (MAX & 6X6 models only) G3L (MAX & 6X6 models only)	715010111	\$64.19
	<ul style="list-style-type: none"> • Easy installation thanks to hook-and-loop fasteners. • Includes left and right divider. • Mesures 9.5" (248 mm). • It is installed at a specific point in the cargo box to divide it neatly into 3 similar sections. • Requires LinQ 30 US Gal (139 L) Trunk Box (715009472). 		
LinQ Trunk Box (87 L) – G3L	G3L	715009312	\$564.49
	<ul style="list-style-type: none"> • Weatherproof polyethylene rear cargo box. • Can be installed on the rear rack only. • Storage capacity of 23 gal (87 L). • Optimized shape of the cargo box base fits the G3L rear rack perfectly. • Lockable with a lock on the front of the box (2 keys included). • Easy to install, easy to remove using the LinQ system. • Installation in LinQ 36" configuration. • Compatible with the passenger seat. • Ability to install LinQ Tool Holders (715008896) on the box. • Up to 3 LinQ Lite Multi Holders (715008087) can be installed to add LinQ Lite accessories to your cargo box. • See table for installation location and requirements. 		
LinQ Trunk Box (87 L) – G3	G3	715009499	\$564.49
	<ul style="list-style-type: none"> • Weatherproof polyethylene rear cargo box. • Can be installed on the rear rack only. • Storage capacity of 23 gal (87 L). • Optimized shape of the cargo box base to fit the G3L rear rack perfectly. • Lockable with a lock on the front of the box (2 keys included). • Easy to install, easy to remove using the LinQ system. • Installation in LinQ 36" configuration. • Compatible with the passenger seat. • Ability to install Tool Holders (715008896) on the box. • Up to 3 LinQ Lite Multi Holders (715008087) can be installed to add LinQ Lite accessories to your cargo box. • See table for installation location and requirements. 		
LinQ Cargo Box (90 L)	G3 (except X mr models) G3L (except X mr models)	715005272	\$532.49
	<ul style="list-style-type: none"> • Made of polyethylene. • Storage capacity of 23 gal (90 L). • Can be installed on the front rack only. • Easy to install, easy to remove using the LinQ system. • Need to remove the front DropDown cover for optimal capacity. • Lockable with a lock on the front of the box (2 keys included). • See table for installation location and requirements. 		
LinQ Cargo Box (53 L)	G3 G3L	715010172 715006997	\$425.99
	<ul style="list-style-type: none"> • Made of polyethylene. • Storage capacity of 14 gal (53 L). • Easy to install and remove with the LinQ system. • Can be installed on the front or rear racks. • New ergonomic and resistant latch system offers excellent sealing. • Possibility to install LinQ 16" accessories on the cover and increase the cargo capacity. • Ability to install LinQ Tool Holders (715008896) on the box. • Lockable with a lock on the front of the box (two keys included). • See table for installation location and requirements. 		
LinQ Low Profile Box (63 L)	G3, G3L	715007827	\$425.99
	<ul style="list-style-type: none"> • Made of impact-resistant injected polypropylene and weatherproof, this box has a storage capacity of 16.6 gal (63 L). • LinQ-mounted for efficient and secure storage, it is locked in place with only a quarter turn. Easy to install, easy to remove using the LinQ system. • Can be installed in a 36" configuration only. • LinQ 16" accessories can be installed on the cover to increase cargo capacity. • Easily carried with the rigid handle. The anti-vibration system prevents the handle from moving while riding. • Support feet at hinge level so the box can stand on its own. • The compact design allows for maximum rear field of vision. • Features a lock on the front of the box (two keys included). • See table for installation location and requirements. 		

LinQ Cargo Basket (90 L)	G3	715010173	\$255.49
	G3L	715005274	



- Made of polyethylene.
- Storage capacity of 23 gal (90 L).
- Easy to install and remove with the LinQ system.
- Can be installed on the front or rear racks.
- Six handles on the contour to easily install bungee cords.
- Ability to install LinQ Tool Holders (715008896) on the basket.
- See table for installation location and requirements.

Large Cargo Box	G3L	715007001	\$681.49
------------------------	-----	------------------	-----------------



- Rear bed to carry large items.
- Anchor points (D-ring), LinQ fixtures for tool holder, and marks to allow the installation of a 16" accessory.
- Also has a mat for the floor and slot to enable the installation of a divider and a slot for a divider to close the recess on the rear vertical lip.
- It is installed on ATV platforms through the LinQ system and hooks for easy installation and removal.

LinQ 9.2 Gal (35 L) Cooler	G3, G3L	715006998	\$641.99
-----------------------------------	---------	------------------	-----------------



- LinQ-mounted for efficient and secure storage, locked in place with only a quarter turn.
- Easy to install, easy to remove using the LinQ system.
- Installation in LinQ 36" configuration.
- Made of polyethylene for exceptional rigidity and durability.
- Storage capacity of 9.2 gal (35 L).
- Lock the cooler on the vehicle using the LinQ Lock (860201968).
- Premium-quality foam insulation for optimal ice retention.
- Molded-in handles for quick installation and removal.
- Option to add LinQ Lite Multi Holder (5 LinQ Lite) (715008087) on the side and at the rear of the cooler.
- A dry basket is included to protect your food from water.
- Drain plug at the bottom to get rid of excess water.
- The new ergonomic and resistant latch system ensures the top is tightly sealed.
- Innovative way to hold 12 cans (355 ml).
- Cannot be installed on the front rack.
- See table for installation location and requirements.

LinQ Rack Extension	G3L	715004954	\$212.99
----------------------------	-----	------------------	-----------------



- Easy to install and remove with the LinQ system.
- Fits front or rear of the vehicle.
- Provides tie-down points to secure cargo on racks.
- Made of steel with anti-corrosion coating and durable powder-coat finish.
- Height of 7".

LinQ LITE ACCESSORIES

NEW LinQ Lite Multi Holder (Front Fenders)	G3, G3L	715009474	\$42.59
---	---------	------------------	----------------



- Allows for installation of select LinQ Lite accessories on the front fenders.
- Three LinQ Lite mounting points allow for versatile storage/hanging options.
- Holds up to two LinQ Lite Cupholders (715009406) or a single LinQ Lite Fender Bag (715009280).
- Finished, robust style.
- Includes necessary installation hardware.
- Sold as a pair.

NEW LinQ Lite Multi Holder	G3 (6x6 models only, except MAX models) G3L (6x6 models only, except MAX models)	295100977	\$32.99
-----------------------------------	---	------------------	----------------





- Allows for installation of select LinQ Lite accessories.
- Capable of mounting on any flat surface such as garage walls for easy accessory storage.
- Five LinQ Lite mounting points allow for versatile storage/hanging options.
- Finished, robust style.
- Includes necessary installation hardware.
- Required to install LinQ Lite Bag (10 L) (715009132).

NEW LinQ Lite Fender Bag	G3, G3L	715009280	\$159.49
---------------------------------	---------	------------------	-----------------



- Provides 5 liters of extra storage space for tools, accessories, or personal items.
- Constructed using high-durability materials designed for enhanced resistance to variable weather conditions.
- Designed to fit on the Outlander fender, it attaches securely with the LinQ Lite Rail.
- Features a zippered pocket and magnetic lid for secure closure.
- Includes an interior mesh pocket, perfect for organizing your essentials.
- Front mesh pocket provides convenient access to frequently used items.
- Requires LinQ Lite Multi Holder (715009474) for installation.

NEW LinQ Lite Bag (10 L)	G3, G3L	715009132	\$159.49
	<ul style="list-style-type: none"> Provides 10 liters of extra storage space for tools, accessories, or personal items. Constructed using high-durability materials for enhanced resistance to variable weather conditions. Shoulder strap included for easy transport. Features a zippered pocket and magnetic lid for secure closure. The yellow interior helps you find what you're looking for in seconds. Includes an interior mesh pocket, perfect for organizing your essentials. 	<ul style="list-style-type: none"> Side mesh pocket on each side provides convenient access to frequently used items. You can install it on several of our LinQ Cargo Boxes with the LinQ Lite Multi Holder (715008087). It can fit on the LinQ Trunk Box (87 L) (715009312 or 715009499) or on the LinQ 9.2 Gal (35 L) Cooler (715006998) or the Large Cargo Box (715007001). Requires the LinQ Lite Multi Holder (715008087) for installation or the LinQ Lite Multi Holder (295100977) if installed on the 6X6 bed wall (except G3L 6X6 MAX). 	

NEW LinQ Lite Cup Holder	G3, G3L	715009406	\$40.49
	<ul style="list-style-type: none"> Keep your beverage within reach. Flexible fins adjust to various beverage container sizes to hold most securely. No permanent installation point means you're free to move it almost anywhere. Tool-less placement, easy to move from place to place. Requires LinQ Lite Multi Holder (715008087) for installation on cargo box or (715009474) for installation on fender. 		

NEW LinQ Lite Multi Holder (5 LinQ Lite)	G3, G3L	715008087	\$42.59
	<ul style="list-style-type: none"> Allows for installation of select LinQ Lite accessories. Five LinQ Lite mounting points allow for versatile storage/hanging options. Finished, robust style. Includes necessary installation hardware. 	<ul style="list-style-type: none"> You can install it on several of our LinQ Cargo Boxes and have as many as three on one box. It can fit on the LinQ Trunk Box (87 L) (715009312 or 715009499) or on the LinQ 9.2 Gal (35 L) Cooler (715006998) or the Large Cargo Box (715007001). Holds up to three LinQ Lite Cup Holders (715009406). 	

NEW LinQ Lite Multipurpose Bag	G3, G3L	295101154	\$106.49
	<ul style="list-style-type: none"> Perfect add-on to store and organize your equipment or store other items like sunscreen, cellphone, sunglasses and more. Tool-less installation in seconds with LinQ Lite clip-in system. Five external pockets for fast access to small necessities. 	<ul style="list-style-type: none"> Features one zippered opening. Dimensions: 16" L x 3.5" W x 10.5" H. Requires LinQ Lite Multi Holder (715008087) for installation. 	

LinQ RACKS & HOLDERS

NEW LinQ Cargo Bed Rack	G3 (6x6 models only) G3L (6x6 models only)	715009336	\$374.49
	<ul style="list-style-type: none"> Strong, durable steel rack. Easy and tool-less installation thanks to the LinQ System. Allows the installation of 16" LinQ accessories with LinQ Sliding Base Kit included. 36" LinQ anchors integrated into the rack. Can be positioned in the front, middle or rear of the cargo bed. Up to 2 racks can be installed at the same time (front & rear position). 	<ul style="list-style-type: none"> Allows multi-level storage on cargo bed. Provides more usable space in the cargo box. The clearance under the rack is 11.5" (294 mm). 4 Tool Holder Bolt-On (715008896) can be installed on each side for a total of 8. Required to install the LinQ Fuel Caddy 5 US Gal (20 L) (715007822). The Fuel Caddy must be installed below the LinQ Cargo Bed Rack. 	

NEW X mr Rear Rack	G3 (except MAX models)	715010217	\$148.99
	<ul style="list-style-type: none"> Black polypropylene glass-filled rear rack replacing the actual rack. LinQ 36" anchors integrated. Possibility to install LinQ 16" accessories into the dropdown to increase the cargo capacity (requires LinQ Base Installation Kit). The rack features six handles crafted with precision. 		

LinQ Front Rack Extension	G3 (except X mr models)	715009281	\$276.99
	<ul style="list-style-type: none"> Easy to install and remove with the LinQ system. Fits front of the vehicle only. Provides tie-down points to secure cargo on racks. Made of aluminum with durable powder-coat finish. Height of 5". 		

LinQ Rear Rack Extension	G3 (except X mr & 6X6 models)	715009475	\$319.49
---------------------------------	-------------------------------	------------------	-----------------



- Easy to install and remove with the LinQ system.
- Fits rear of the vehicle only.
- Provides tie-down points to secure cargo on racks.
- Made of aluminum with durable powder-coat finish.
- Height of 7".

LinQ Tool Holder	G3, G3L	715007358	\$63.99
-------------------------	---------	------------------	----------------



- Ultra-versatile tool holder.
- Convenient swivel-latch allows tools to be stored in any orientation.
- Sold in pairs.

LinQ Gear Grips	G3, G3L	715005340	\$160.49
------------------------	---------	------------------	-----------------



- Durable and flexible grips provide a custom fit for a variety of items from 1" to 4" (2.5 cm to 10 cm) in diameter.
- Heavy-duty design for carrying bows, fishing poles, rakes, farm tools and more.
- Quick-release button opens grip quickly for easy access to gear.
- Heavy-duty base system built for the toughest adventures.
- Make transporting your tools a snap by combining the Gear Grips with the LinQ system.
- 360° orientation.
- Sold in pairs.

Gear Grips	G3L	715001421	\$99.49
-------------------	-----	------------------	----------------



- Durable, flexible grips cushion and protect while providing a custom fit for a variety of items from 1" to 4" (2.5 cm to 10 cm) in diameter.
- Heavy-duty design for carrying bows, fishing poles, rakes, farm tools and more.
- Quick-release button opens grip quickly for easy access to gear.
- Heavy-duty base system built for the toughest adventures.
- Easy installation on tubular racks, extension racks, brackets or bumpers.
- Sold in pairs.

LinQ Gun Case	G3, G3L	715009240	\$277.99
----------------------	---------	------------------	-----------------



- The practical design lets riders store shotguns and rifles up to 52" (132 cm), even with most optic configurations.
- Adapts to different weapon shapes and features with foam cushions that can be repositioned.
- The Gun Case is LinQ-mounted for efficient and secure storage, and is locked in place with only a quarter turn.
- The LinQ Gun Case must be installed on the front compartment lid using the LinQ Base Installation Kit (860201806), on the Front Rack or on the fender position using the LinQ Gun Case Mounting Kit (715006074).
- Can't be installed on the rear lid due to weight limitation.

LinQ Gun Case Mounting Kit – Fender Position	G3, G3L	715006074	\$128.49
---	---------	------------------	-----------------



- This kit is required to install the LinQ Gun Case on the fender position.
- Installs on the right side of the vehicle, and the safety system allows the driver or passenger to quickly exit the vehicle.
- The low-profile mounting system can be left on the vehicle year-round and doesn't get in the way when the Gun Case is not installed.

HOLDERS

NEW Tie-Down Anchors	G3 (6x6 models only) G3L (6x6 models only)	715010487	\$42.59
-----------------------------	---	------------------	----------------



- Made of high-strength cast aluminum.
- Coated with corrosion resistant black coating.
- Add extra points on the wall of the cargo bed for tying down cargo in the back of your vehicle.
- Includes 4 pieces.

Tool Holder Bolt-On	G3, G3L	715008896	\$48.99
----------------------------	---------	------------------	----------------





- Tool Holder is made to fit the LinQ Cargo Basket (90 L) (715005274 & 715010173), LinQ Cargo Box (53 L) (715006997 & 715010172), LinQ Trunk Box (139 L) (715006097 & 715009472), LinQ Cargo Bed Rack (715009336), and LinQ Trunk Box (145 L) (715005273 & 715009471).
- Convenient swivel-latch allows tools of all shapes to be stored in the proper orientation.
- Sold in pairs.
- Several degrees of adjustment.

Multi-Fit Holder	G3L	715002354 • Single	\$64.99
		715001945 • Double	\$104.99
		<ul style="list-style-type: none"> • Open U-shaped bracket for carrying tools (shovel, axe) and hunting weapons (rifle, bow) that are safely secured, but easily accessible. • Easy installation on tubular rack, extension racks, basket or bumpers. • Sold in pairs. 	

LinQ MOUNTING

NEW LinQ Sliding Base Installation Kit	G3 (6x6 models only)	715009123	\$58.56
	G3L (6x6 models only)		
		<ul style="list-style-type: none"> • This LinQ Sliding Base Installation Kit comes in 2 parts. • The first part, the LinQ Sliding Mount Plate, can stay on your vehicle at all times without interfering with loading, thanks to its flat design. • When you need the second part, the LinQ Sliding Base, you can simply clip it in in less than 2 seconds. • The LinQ Sliding base is therefore non-permanent, easy to remove, and you can easily play with and swap anchors. • Sold as a pair. • Includes LinQ Sliding Mount Plate, LinQ Sliding Base, and hardware. 	

LinQ Base Installation Kit	G3, G3L	860201806	\$42.49
			
<ul style="list-style-type: none"> • Unique mounting fastener usable on any LinQ system accessory. • Included: 2 cargo LinQ bases and hardware. 			

LinQ Base	G3L	715002350	\$25.99
			
<ul style="list-style-type: none"> • Made of polypropylene glass fiber. • Allows you to install LinQ accessories. • Sold in pack of 4. 			

CARGO & STORAGE

LinQ Replacement Parts		715010798	\$42.49
			
<ul style="list-style-type: none"> • Unique mounting fastener usable on any LinQ system accessory. • Tool-less installation and removal. • Sold in pairs. 			

LinQ Lock	G3, G3L	860201968	\$66.99
			
<ul style="list-style-type: none"> • Simple way to securely lock most LinQ accessories. • Lock cover protects lock from the elements. • Corrosion resistant. • Pack of 1, includes 2 keys. • Not compatible with LinQ 4.2 US Gal (16 L) Cooler, LinQ Tool Box, LinQ Tool Holder, LinQ Gear Grips or LinQ Cargo Bed Rack (715009336). 			

Soft Storage Bag (70 L)	G3L	715007002	\$234.49
			
<ul style="list-style-type: none"> • Carry your gear in a weatherproof bag. • Soft bag with a storage capacity of 18.5 gal (70 L) designed to maximize space in the front or rear of the vehicle. • 3-compartment bag with removable dividers. • Easy to install with strap system. • X mr models: Fits on rear rack only. 			

CHOOSE THE RIGHT MOUNTING STYLE

Windshields do more than block wind—they cut fatigue, improve comfort, and keep debris out of the zone. Outlander G3 and G3L models offer two smart mounting styles built to match different ride preferences and functional needs.



HANDLEBAR-MOUNTED

Quick to install, these windshields move with the handlebars for dynamic coverage that tracks with every turn. A flexible, straightforward option for wind protection on the go.



CONSOLE-MOUNTED

They stay fixed to the frame for stable, consistent protection from wind and debris, no matter how you steer. Plus, since they're not mounted on the handlebars, they won't affect handling or control.



WINDSHIELDS

Adventure Side Wind Deflectors	G3L (except X mr and Electric models)	715005862	\$134.99
---------------------------------------	---------------------------------------	------------------	-----------------



- Side Wind Deflectors for additional wind protection.
- Easy installation.
- Console Extension (715005368) is required for installation.
- Works with Adventure Windshields (715005860, 715005377, 715007268).
- Not compatible with Integrated Audio System (715005354).

Adventure High Windshield – Hardcoated	G3L (except X mr and Electric models)	715007268	\$249.99
---	---------------------------------------	------------------	-----------------



- Adventure windshield with three-position adjustable height.
- 14" (36 cm) high to protect against wind and winter weather.
- Made of injected polycarbonate with a thickness of 5/32" (4 mm) with ultra-resistant Quantum¹ coating.
- Provides excellent optical clarity and better abrasion resistance.
- Console Extension (715005368) is required for installation.
- Side Wind Deflectors (715005862) available for added protection.

Adventure High Windshield	G3L (except X mr and Electric models)	715005377	\$199.99
----------------------------------	---------------------------------------	------------------	-----------------



- Adventure windshield with three-position adjustable height.
- 14" (36 cm) high to protect against wind and weather.
- Made of injected polycarbonate with a thickness of 5/32" (4 mm).
- Console Extension (715005368) is required for installation.
- Side Wind Deflectors (715005862) available for added protection.

Adventure Low Windshield	G3L (except X mr and Electric models)	715005860	\$179.99
---------------------------------	---------------------------------------	------------------	-----------------



- Adventure windshield with three-position adjustable height.
- 10 in. (25 cm) high for wind protection.
- Made of injected polycarbonate with a thickness of 5/32" (4 mm).
- Console Extension (715005368) is required for installation.
- Side Wind Deflectors (715005862) available for added protection.

Console Extension	G3 (except X mr models)	715009218	\$212.99
--------------------------	-------------------------	------------------	-----------------

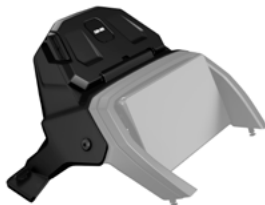

- Integrated storage compartment (2 L) with magnetic mount safe for your electronic device.
- Robust injected fiber-reinforced-polypropylene construction makes it easy to fit and install.
- 25 times stronger than any smartphone's weight, so you can ride through rough terrain confidently.
- Two possible positions for your electronic device: portrait and landscape.
- Includes everything needed for installation on your favorite electronic devices: one pre-assembled Can-Am plate with 3M multi-surface adhesive.
- Includes guide clips molded into the door to feed the charging cable.
- Possibility of installing USB outlet in storage compartment (USB power outlet sold separately).
- Required for the installation of the Adventure Windshield and Side Wind Deflectors.
- Not compatible with Snorkel Kit.
- Includes tether cord for additional peace of mind.

Adventure Side Wind Deflectors	G3 (except X mr models)	715009462	\$138.49
---------------------------------------	-------------------------	------------------	-----------------



- Side Wind Deflectors for additional wind protection.
- Easy installation.
- Controllable vents to manage airflow.
- Console Extension (715009218) is required for installation.
- Works with Adventure Windshields (715009219, 715009453, 715009458).
- Not compatible with Integrated Audio System (715005354).

Adventure High Windshield – Hardcoated	G3 (except X mr models)	715009458	\$329.99
---	-------------------------	------------------	-----------------



- Quickly change your wind protection with the flip of both levers.
- 14" (36 cm) high to protect against wind and winter weather with a 2" (5 cm) adjustment.
- Made of injected polycarbonate with a thickness of 5/32" (4 mm) with ultra-resistant Quantum¹ coating.
- Provides excellent optical clarity and better abrasion resistance.
- Console Extension (715009218) is required for installation.
- Side Wind Deflectors (715009462) available for added protection.

Adventure High Windshield	G3 (except X mr models)	715009453	\$269.99
----------------------------------	-------------------------	------------------	-----------------

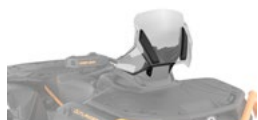

- Quickly change your wind protection with the flip of both levers.
- 14" (36 cm) high to protect against wind and weather with a 2" (5 cm) adjustment.
- Made of injected polycarbonate with a thickness of 5/32" (4 mm).
- Console Extension (715009218) is required for installation.
- Side Wind Deflectors (715009462) available for added protection.

Adjustable Adventure Low Windshield	G3 (except X mr models)	715009219	\$249.99
--	-------------------------	------------------	-----------------



- Quickly change your wind protection with the flip of both levers.
- 10" (25 cm) high for wind protection with a 2" adjustment.
- Made of injected polycarbonate with a thickness of 5/32" (4 mm).
- Console Extension (715009218) is required for installation.
- Side Wind Deflectors (715009462) available for added protection.

NEW High Windshield Kit	G3 (except X mr, Backcountry and XT-P)	715006480	\$219.99
	G3L (except X mr models)		
	G3 (Backcountry & XT-P models only)	715010902	



- 11" (28 cm) high, for wind protection and winter applications.
- The windshield is made of polycarbonate, 1/8" thick (3 mm).
- Integrated plastic injected handguard with Can-Am logo.
- Requires Handguards Frame Kit (715010295) for installation on units with no factory handguards.
- Not compatible with Integrated Audio System (715005354) or Console Extension (715009218 or 715005368).

NEW Extra High Windshield Kit	G3 (except X mr, Backcountry and XT-P)	715006481	\$249.99
	G3L (except X mr models)		
	G3 (Backcountry & XT-P models only)	715010947	



- 16" (41 cm) high, for wind protection and winter applications.
- The windshield is made of polycarbonate, 1/8" thick (3 mm).
- Integrated plastic injected handguard with Can-Am logo.
- Requires Handguards Frame Kit (715010295) for installation on units with no factory handguards.
- Not compatible with Integrated Audio System (715005354) or Console Extension (715009218 or 715005368).

Console Extension	G3L (except X mr and Electric models)	715005368	\$212.99
--------------------------	---------------------------------------	------------------	-----------------



- Integrated storage compartment (1 gal/4 L) with magnetic mount safe for your electronic device.
- Robust injected fiber-reinforced-polypropylene construction makes it easy to fit and install.
- Magnetic mount is 25 times stronger than any smartphone's weight, so you can ride through rough terrain confidently.
- Two possible positions for your electronic device: portrait and landscape.
- Includes everything needed for installation on your favorite electronic devices: two pre-assembled Can-Am plates with 3M multi-surface adhesive.
- Includes guide clips molded into the door to feed the charging cable.
- Possibility of installing USB outlet in storage compartment (USB power outlet sold separately).
- Required for the installation of the Adventure Windshield and Side Wind Deflectors.
- Not compatible with Snorkel Kit.
- Includes tether cord for additional peace of mind.

Console Extension USB Power Outlet	G3 (except X mr & Electric models) G3L (except X mr & Electric models)	715008750	\$74.99
---	---	------------------	----------------



- Useful for the Console Extension (715005368 & 715009218) to plug your electronic device charger into the compartment.
- USB-A and USB-C ports.
- Rubber cap protects ports when not in use.
- Backlit to highlight the USB ports.
- Console Extension (715005368 or 715009218) is required for installation.

HANDLEBARS & MIRRORS

NEW Handguards Frame Kit	G3 (except X mr 1000R models), G3L	715010295	\$63.99
---------------------------------	------------------------------------	------------------	----------------



- Lightweight black die-cast aluminum full wrap frame.
- Mounting system leaves the handlebar free.
- Includes complete hardware.
- Requires Can-Am Handguards (715010293/715010294) or XT Handguards (715010296) or Sport Handguards (715010297).
- Required to install High & Extra High Windshield Kit (715006480, 715006481, 715010902 & 715010947) for units with no factory handguards.

NEW Touring Handguards	G3 (except X mr 1000R models), G3L	■ 715010293 • Black	\$63.99
		■ 715010294 • Neo Yellow	\$63.99



- Protect against wind, branches and debris.
- Rugged injected plastic deflectors with Can-Am logo.
- New ergonomic design offers better comfort for the hand and increases protection.
- Include complete hardware.
- Require Handguards Frame Kit (715010295).

NEW XT Handguards	G3 (except X mr 1000R models), G3L	715010296	\$74.49
--------------------------	------------------------------------	------------------	----------------

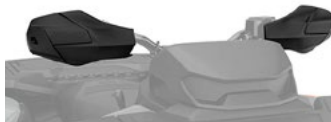

- Protect against wind, branches and debris.
- Rugged injected plastic deflectors with Can-Am logo.
- New ergonomic design offers better comfort for the hand and increases protection.
- Include complete hardware.
- Require Handguards Frame Kit (715010295).

NEW Sport Handguards	G3 (except X mr 1000R models), G3L	715010297	\$63.99
-----------------------------	------------------------------------	------------------	----------------



- Give your ATV a sporty look with the low-profile design.
- Rugged injected plastic deflectors with Can-Am logo.
- Include complete hardware.
- Require Handguards Frame Kit (715010295).

NEW Handlebar Muffs	G3 (except X mr 1000R models), G3L	715009288	\$127.79
----------------------------	------------------------------------	------------------	-----------------



- Ultra warm muffs for extreme cold conditions.
- Thermoformed construction allows muffs to keep their shape and provides more space for hand movement.
- Easy to install and remove without any tools.
- Large transparent section allows visibility of control switches.
- Note: Always install complete Can-Am Touring or XT Handguards with these Handlebar Muffs.
- Requires Full Wrap Handguards Frame Kit (715010295) with Touring Handguards (715010293 or 715010294) or XT Handguards (715010296).
- Not compatible with Sport handguards (715010297).
- Installing the muffs without the handguard's large plastic parts can cause interference with controls.
- Not compatible with Windshield Kits (715006481, 715006480, 715010902 & 715010947).

Driver Full Wrap Handguards	G3 (base & DPS models only) G3L (base & DPS models only)	■ 715005361 • Black	\$159.49
		■ 715005362 • Neo Yellow	\$148.99



- Protect against wind, branches and debris.
- Rugged injected plastic deflectors with Can-Am logo.
- Lightweight black die cast aluminum full wrap frame.
- New ergonomic design offers better comfort for the hand and increases protection.
- Mounting system leaves the handlebar free.
- Include complete hardware.

Passenger Wind Deflectors	G3 (MAX models only) G3L (MAX models only)	715001669	\$98.99
----------------------------------	---	------------------	----------------



- These wind deflectors fit on the passenger handles and provide greater comfort while riding.
- Easy to install and remove.

Handlebar Mirrors	G3, G3L	715005366	\$74.49
--------------------------	---------	------------------	----------------



- Adjustable handlebar mounted convex mirrors.
- The convex surface allows improved visibility with a wider field of view.
- Don't require a windshield or fairing to be mounted.
- Work with all windshield options.

SKID PLATES

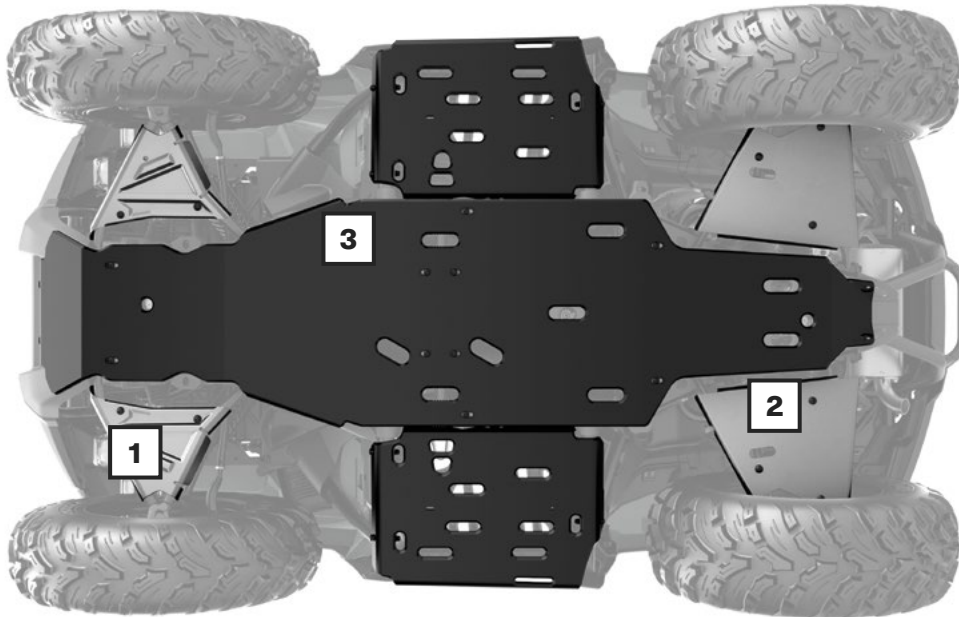

Our Skid Plates deliver the durability, strength, and reliability your adventures need. Protect the underbelly of your vehicle from front to rear, with folded ends at the footwells for a little extra. They combine materials for peak protection: With aluminum A-arms and a plastic underbelly, your ride can drive across rough terrain confidently.

- Quick and easy, bolt-on installation. No need to remove factory skid plates. No more rivets or rivnuts.
- Thicker underbelly plates (10 mm).

OUTLANDER

G3		G3L		ELECTRIC	
2025 and Up		2023 and Up		2026	
Except MAX models	MAX models only	Except MAX models	MAX models only	Except MAX models	MAX models only

SKID PLATE PROTECTION KIT

715009216	715009217	715010280	715010281		
-----------	-----------	-----------	-----------	--	--

INDIVIDUAL SKID PLATES

1 Front Aluminum A-Arm Protectors	715009214 (except G3 X mr & Backcountry models)	715009214 (except G3 X mr & Backcountry models)	715005305	715005305	715005305	715005305
2 Rear Aluminum A-Arm Protectors (sold in pairs)	715009215 (except G3 X mr & Backcountry models)	715009215 (except G3 X mr & Backcountry models)	715005308	715005308	715005308	715005308
3 HMWPE Underbelly and Footboard Plates	715009864	715009865	715009864	715009865		

SKID PLATES

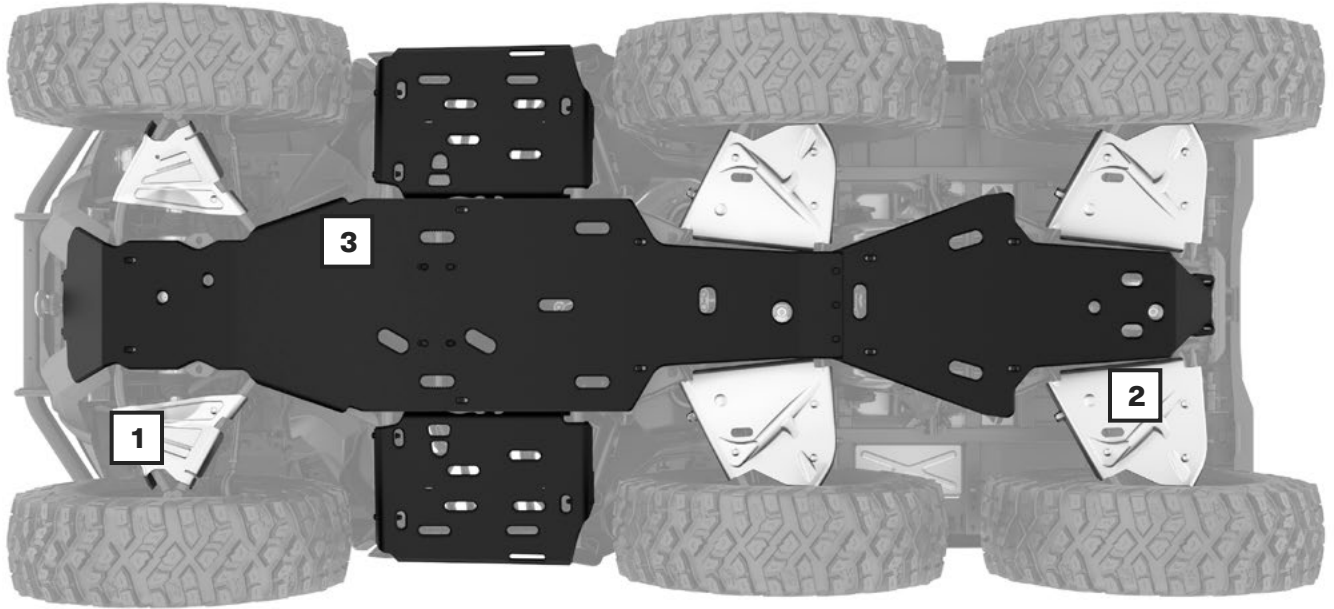

Our Skid Plates deliver the durability, strength, and reliability your adventures need. Protect the underbelly of your vehicle from front to rear, with folded ends at the footwells for a little extra. They combine materials for peak protection: With aluminum A-arms and a plastic underbelly, your ride can drive across rough terrain confidently.

- Quick and easy, bolt-on installation. No need to remove factory skid plates. No more rivets or rivnuts.
- Thicker underbelly plates (10 mm).

OUTLANDER 6X6

G3 6X6		G3L 6X6	
2026		2026	
Except MAX models	MAX models only	Except MAX models	MAX models only

SKID PLATE PROTECTION KIT

	715009343	715009344	715009341	715009342
--	-----------	-----------	-----------	-----------

INDIVIDUAL SKID PLATES

1	Front Aluminum A-Arm Protectors	715009214	715009214	715005305	715005305
2	Rear Aluminum A-Arm Protectors (sold in pairs)	715009215	715009215	715005308	715005308
3	HMWPE Underbelly and Footboard Plates	715009339	715009340	715009339	715009340

BUMPERS & GUARDS

NEW XT Front Bumper | G3 (except X mr) | **715009289** | **\$308.99**



- Heavy-duty construction with profiled steel tubes provides the most complete protection for your vehicle.
- Wide and sturdy construction with black powder-coat finish and metal corners.
- Integrated tow hooks and light mounting points.
- Protects vehicle lights and corners.
- Winch compatible.

XU Front Bumper | G3L | **715006614** | **\$340.99**



- Heavy-duty tubular construction provides the most complete protection for your vehicle.
- Protects vehicle lights and corners.
- Winch compatible.
- Integrated tow hook.
- Similar to the XU model's bumper.

XT Front Bumper | G3L | **715004952** | **\$180.99**



- Provides additional protection for your vehicle against the elements.
- Tough and durable.
- Large tube construction with black powder coat finish.
- Similar to stock bumper on XT models.
- Mounting plate included for tow hook.

Extreme Front Bumper Plates | G3 (except X mr models) | **715009293** | **\$159.49**

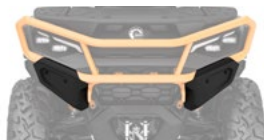

- Ultra-robust steel construction provides additional protection to the front of the vehicle in rough terrain.
- Compatible with all front bumpers.
- Durable powder coat finish.
- Not compatible with track systems.

Extreme Front Bumper Plate | G3L (except X mr models) | **715005439** | **\$159.49**



- Ultra-robust construction provides additional protection to the front of the vehicle in rough terrain.
- Compatible with all front bumpers.
- Not compatible with track systems.

Front Tow Hook | G3L | **715008842** | **\$48.99**



- Provides a solid anchor when towing is needed or when transporting the vehicle.
- Allows you to attach most hooks or straps.
- This tow hook offers 3,500 lb (1,587 kg) of towing capacity.
- Made of forged steel.
- XT Front Bumper (715004952) required for installation.
- Not compatible with Outlander XT stock bumper.

NEW XT Rear Bumper | G3 (except 6x6 models) | **715009292** | **\$212.99**







- Made of profiled steel tubes for complete protection of the vehicle's rear.
- Provides additional protection for your vehicle against obstacles.
- Protects the rear lights of the vehicle without obstructing them.
- Wide and sturdy construction with black powder-coat finish and metal corners.



NEW Rear Bumper | G3 (6x6 models only)
G3L (6x6 models only) | **715009770** | **\$181.04**



- High-resistance steel tubular construction.
- Anti-corrosion coating with durable powder coat finish.
- Provides added protection to the rear.
- Required to install the Cargo Bed Side Protectors (715009345).

NEW Cargo Bed Side Protectors	G3 (6x6 models only) G3L (6x6 models only)	715009345	\$425.99
	<ul style="list-style-type: none"> • 1.5" (3.8 cm) diameter steel-tube construction. • Anti-corrosion coating with durable powder coat finish. • 3 integrated hook points on each side to secure cargo. • Requires Rear Bumper (715009770) for installation. • Not compatible with the LinQ Cargo Basket (90 L) (715010173 & 715005274), LinQ Trunk Box 23 US Gal (87 L) (715009499), or LinQ Cargo Box 14 US Gal (53 L) (715010172 & 715006997). 		
Full Rear Bumper	G3L (except 6X6 models)	715008738	\$234.49
	<ul style="list-style-type: none"> • Provides additional protection for your vehicle against obstacles. • Protects the rear lights of the vehicle without obstructing them. • Strong and durable, it must be added to the XT rear bumper (stock or accessory) for full protection. • Wide and sturdy tubular construction with black powder-coat finish and metal corners. 		
XT Rear Bumper	G3L (STD, DPS & X mr models only)	715004953	\$138.49
	<ul style="list-style-type: none"> • Sturdy tubular construction. • Protects the vehicle against obstacles. • Standard on Outlander XT and Outlander PRO. • Fits base models with grab bar only. • Required to install the Full Rear Bumper. 		
Fender Flares	G3L (except Electric models)	715005349	\$138.49
	<ul style="list-style-type: none"> • Kit is designed to deliver extra protection to your vehicle from dirt and debris. If you enjoy riding in the mud, it's a must. • Made of injected plastic that hugs your vehicle fenders perfectly. • Give vehicle added flair for a rugged, cool look. • Include front and rear extensions and all mounting hardware. • Not compatible with European vehicles. 		

LIGHTS & ELECTRICAL

LIGHTS			
3.5" (9 cm) LED Lights (2 X 14 W) LED Driving Lights	G3 (except X mr models), G3L	715009775	\$283.49
	<ul style="list-style-type: none"> • 14 W LED lights producing 1,260 lumens each. • Equipped with 6 high power LEDs in a heavy-duty die cast aluminum housing. • Features 2 attachment points — if one attachment point fails due to a collision, rotate to the next channel point and re-mount the light. • Sold in pairs. 	<ul style="list-style-type: none"> • EC compliant. • Spot lens for a narrow and long light beam spread, ideal when driving at higher speeds. • XT or XU Front Bumpers (715004952, 715009289 & 715006614) and Light Power Cable (715005353) required for installation. • Can also be installed on the stock front bumpers (XT and XU). 	
3.5" (9 cm) LED Lights (2 X 14 W) LED Flood Lights	G3 (except X mr models), G3L	715009774	\$283.49
	<ul style="list-style-type: none"> • 14 W LED lights producing 1,260 lumens each. • Equipped with 6 high power LEDs in a heavy-duty die cast aluminum housing. • Features 2 attachment points — if one attachment point fails due to a collision, rotate to the next channel point and re-mount the light. • Sold in pairs. • EC compliant. 	<ul style="list-style-type: none"> • Flood lens for a wide light beam spread, ideal for working applications like plowing or for cornering, or for dusty or foggy riding conditions. • XT or XU Front Bumpers (715004952, 715009289 & 715006614), and Light Power Cable (715005353) required for installation. • Can also be installed on the stock front bumpers (XT and XU). 	
NEW SMART 10" (25 cm) LED Light Bar	G3 (except X mr models), G3L	715008745	\$374.49
	<ul style="list-style-type: none"> • The perfect combination of powerful white and selective yellow LEDs. • Selective yellow is ideal for driving in low visibility conditions. • The light is composed of 16 white LEDs and 8 yellow LEDs. • Spot and Flood combo beam. • The side lens design provides highly effective wide-angle illumination. • Features a signature LED light that enhances the vehicle's appearance when not activated. 	<ul style="list-style-type: none"> • The white LEDs produce 8,100 raw lumens and the selective yellow 2,640 raw lumens, delivering stunning lighting performance. • The lens is made from hard-coated polycarbonate. • IP67 and IP69k submersible and pressure washer safe. • Switch options: Off, Low and High. Color change by flicking the switch quickly. • Wiring Harness (715010044) is required for installation. Sold separately. • Just a heads-up, you'll need a bumper for this. 	

10" (25 cm) Double Stacked LED Light Bar (60 W)	G3 (except X mr models), G3L	715002933	\$395.49
--	------------------------------	------------------	-----------------



- Equipped with 12 5 W Cree LEDs.
- 5,400 lumens.
- Rugged and waterproof.
- Packs a big punch for its size.
- EC compliant.
- XT or XU Front Bumpers (715004952, 715009289, and 715006614), and Light Power Cable (715005353) required for installation.
- Can also be installed on the stock front bumpers (XT and XU).

15" (38 cm) Double Stacked LED Light Bar (90 W)	G3 (except X mr models), G3L	715002934	\$480.99
--	------------------------------	------------------	-----------------



- Equipped with 18 5 W Cree LEDs.
- 8,400 lumens.
- Complements the Light Racks and most bumpers.
- Rugged and waterproof.
- Lights up to more than 1,900 ft (580 m) in front of the vehicle and around 65 ft (20 m) wide on each side.
- EC compliant.
- XT Front Bumper (715004952 and 715009289) and Light Power Cable (715005353) are required for installation.
- Can also be installed on the stock front bumpers (XT only).

NEW LED Light Bar Harness	G3 (except X mr models), G3L	715010044	\$96.29
----------------------------------	------------------------------	------------------	----------------



- Required to install SMART 10" (25 cm) LED Light Bar (715008745).
- Plug & play installation.
- Includes harness and hardware.

Light Power Cable <i>(Not illustrated)</i>	G3, G3L	715005353	\$55.49
--	---------	------------------	----------------

- Required for installation of the 10" (25 cm) and 15" (38 cm) LED Light Bars, as well as the 3.5" (9 cm) LED Lights.

RAM¹ LED Spotlight	G3, G3L	710005423	\$174.99
--------------------------------------	---------	------------------	-----------------



- 540-lumen (9 W) heavy-duty LED spotlight standard-equipped with 1" (2.5 cm) diameter rubber-coated double ball and socket system.

ELECTRICAL

NEW Power Tilt Bed	G3 (6x6 models only) G3L (6x6 models only)	715009338	\$695.49
---------------------------	---	------------------	-----------------



- Powerful cargo box tilter with dash-integrated switch.
- Supports loads of up to 1,000 lb (453 kg).
- Features a strong and fast tilting electric actuator.

Integrated Heated Grips & Thumb Throttle Combo	G3 (except X mr 1000R), G3L	715009284	\$359.99
---	--------------------------------	------------------	-----------------



- Heat levels for grips and thumb displayed on vehicle screen.
- Ergonomic button integrated on LH grip.
- Single button for both grips and thumb heat selection.*
- Five temperature settings for the thumb and grips.
- Adjustable heat ratio between grip and thumb warmer.*
- Hold button to reach maximum heat quickly.
- Remembers your last heat setting.
- IP67-rated waterproof sealing keeps the elements out.
- ECE compliant.
- Plug-and-play installation.
- Clamp-on grips, no glue required.

**Models with touchscreen or color display provide enhanced user interface with independent grips and thumb heat level selection.*

Heated Passenger Grips & Visor Outlet	G3 (MAX models only), G3L (MAX models only)	715005358	\$374.49
--	--	------------------	-----------------

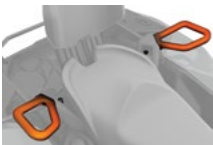



- Replace your stock passenger handles.
- Dual temperature switch integrated into seat arm for 3-zone heated handles and grips.
- Heated visor outlet integrated into seat arm.

Seat Heater	G3L	715007211	\$139.99
	<ul style="list-style-type: none"> • 25 W seat heater delivers chill-free riding comfort. • One temperature only. • Heated pad and electrical harness only. • Heavy-Duty Seat Cover (715008311) is required for installation on 1-up models. • Heavy-Duty Seat Cover (715008313) is required for installation on 2-up models. 		
Heated Visor Outlet	G3, G3L	715001246	\$60.99
	<ul style="list-style-type: none"> • Strategically positioned on vehicle to maintain your agility. • Optional visor outlet that delivers fog-free riding. • Quick and easy installation. • Sold individually. • Heated Visor not included. 		
USB Power Outlet Kit	G3, G3L	219400510	\$42.99
	<ul style="list-style-type: none"> • Recharges your electronic devices while riding* (smartphone, MP3, heating gear, etc.). • Dual port USB connectors. • Plug-and-play kit. • Replaces the vehicle's 12 V socket. <p><i>*The power outlet is not capable of recharging all device types while riding.</i></p>		
USB Intelligent Power Outlet Kit	G3, G3L	715009117	\$63.99
	<ul style="list-style-type: none"> • Power all your electronics with this easy-to-mount USB plug. • Provides one USB-A 3.0 and one USB-C (PD) plug. • Power rate: 36 watts. • Intelligent USB charger for a fast charge when battery is low. • Replaces the vehicle's 12 V socket. 		
NEW 10.25 in. Color Touchscreen Display Protector	Vehicle equipped with 10.25 in. Color Touchscreen Display	860202680	\$27.49
	<ul style="list-style-type: none"> • Tempered glass – 0.3 mm thick. • 9H hardness for tough protection. • 100% bubble free adhesive. • Anti-scratch, anti-glare and anti-fingerprint. • Maintains 99.99% clarity. • Easy to clean. • Includes cleaning tools: wet wipe, dry wipe, dust absorber and soft cloth. 		
Cellphone Holder	G3, G3L	715008786	\$106.99
	<ul style="list-style-type: none"> • Water resistant door allows for perfect phone positioning. • Features capacitive and resistive touchscreen technology. • Spring system in back plate automatically adjusts for thickness. • Fits all cellphones within 7.2" (185 mm) x 3.3" (85 mm) x 0.6" (15 mm) dimensions. • Works with almost all charger wires. • Does not include cellphone or charging wires. • Requires the RAM Mount for Cellphone Holder (715001985) or the Console Extension (715005368) for installation. • If installed on the Console Extension, the Console Extension USB Power Outlet (715008750) is required to charge cellphone. • If installed on the Console Extension, Driver Full Wrap Handguards are incompatible. 		
RAM[†] Mount for Cellphone Holder	G3, G3L	715001985	\$71.99
	<ul style="list-style-type: none"> • Convenient bracket for installing the Cellphone Holder (715008786) (not included) onto your unit's handlebar. 		
Integrated Audio System	G3, G3L	715005354	\$909.99
	<ul style="list-style-type: none"> • Fully integrated and weatherproof audio system. • Includes two 6.5" front fender Bluetooth speakers giving you fingertip control of the tracks you're playing. • Designed to be Can-Am tough in the most demanding riding conditions. • Expertly tuned for exceptional sound, even when you're on the move on your Outlander. • Comes with two speakers, each with 50 W dynamic power, for a total of 100 W dynamic power. • Seamless integration and operation from any Bluetooth-enabled devices, or via an auxiliary port. • Plug-and-play audio system specifically designed not to drain the battery. • Compatible with the Console Extension (715005368 or 715009218) and Adventure Windshields. • Not compatible with the Adventure Side Wind Deflectors (715005862 or 715009462). • Not compatible with Windshield Kits (715006481, 715006480, 715010902 & 715010947). • EC compliant. 		
<p><i>Note: We recommend you use 20 kbps MP3, 192-256 kbps AAC or AIFF, WAV formats to match the potential of the speaker. More compressed formats will probably have degraded sound quality.</i></p>			

Bluetooth Handlebar Soundbar by MTX	G3 (except X mr & Electric models)	219400840	\$523.99
	G3L (except Electric models)		
	<ul style="list-style-type: none"> Bluetooth speaker with the unbeatable convenience of fingertip control. Rugged IP66-rated weather-resistant speaker designed for outdoor use. Driven by 150 watts of quality audio power. Seamless integration and operation from Bluetooth enabled devices. 	<ul style="list-style-type: none"> Includes input, ground and ignition wires, plus auxiliary port and 3.5" (8.89 cm) connector cable. Not compatible with XT Handlebar Protector Kit. EC compliant. 	<i>Note: We recommend you use 320 kbps MP3, 192-256 kbps AAC or AIFF, WAV formats to match the potential of the speaker. More compressed formats will probably have degraded sound quality.</i>

Quick Connect Cable with Battery Indicator		715006055	\$23.99
	<ul style="list-style-type: none"> Quickly and easily connect and charge different batteries with your charger. 3-color LED indicator provides constant battery health indication. Sold individually. 		

RFID Key Green D.E.S.S.™	G3 (with ITC)	710005232	\$63.49
	G3L (with ITC)		
	<ul style="list-style-type: none"> Top-security anti-theft protection for your vehicle. Encrypted chip technology restricts access to your vehicle's electronic ignition system. One vehicle/one code. A vibration/shock-resistant ball-and-socket design that ensures a reliable connection. 	<ul style="list-style-type: none"> 3 programmable modes: <ul style="list-style-type: none"> Work mode: Limits vehicle speed to 40 kph (25 mph) but does not limit engine torque. Normal mode: Limits vehicle speed to 70 kph (44 mph) and 50% torque reduction. Performance mode: No restrictions. 	

NEW Mobile EVSE Level 1 Charging Cable	G3L (Electric models only)	219401227	\$354.49
	<ul style="list-style-type: none"> Feature compact size, overheating protection mechanism, and an IP67 ingress protection rating. Bright and smooth panel design with built-in LED indicators. Operates in a wide range of temperatures (-30°C to 50°C). 	<ul style="list-style-type: none"> Included: <ul style="list-style-type: none"> 1 mobile connector – 9.5' (3 M) cable 1 storage bag AC type plug: NEMA 5-15 Voltage: 120 V Charging Power: 12 A 	

WINCHES

CAN-AM HD WINCHES

Can-Am HD 2500 Winch	G3 (except X mr) G3L (2025 & up)	715009797	\$395.99
	<ul style="list-style-type: none"> Ergonomic clutch handle. Rugged all-steel gears and bushings for more torque and longer life. Automatic 100% load-holding brake. Can be used with the Wireless Winch Remote (715008286) or the Can-Am HD Wired Remote Control (715008121) (sold separately). 	<ul style="list-style-type: none"> Pulling strength capability of 2,500 lb (1,134 kg). 50 ft. of 3/16" (15.2 m of 4.8 mm) wire steel cable. Heavy-duty 4-way roller fairlead. Weather-sealed handlebar-mounted switch. Sealed solenoid for all-weather protection. Plug-and-play wiring. EC & UKCA compliant. 	

Can-Am HD 3500 Winch	G3 (except X mr) G3L (2025 & up)	715009798	\$427.99
	<ul style="list-style-type: none"> Ergonomic clutch handle. Rugged all-steel gears and bushings for more torque and longer life. Automatic 100% load-holding brake. Can be used with the Wireless Winch Remote (715008286) or the Can-Am HD Wired Remote Control (715008121) (sold separately). 	<ul style="list-style-type: none"> Pulling strength capability of 3,500 lb (1,588 kg). 50 ft. of 7/32" (15.2 m of 5.6 mm) wire steel cable. Heavy-duty 4-way roller fairlead. Weather-sealed handlebar-mounted switch. Sealed solenoid for all-weather protection. Plug-and-play wiring. EC and UKCA compliant. 	

Can-Am HD 2500 Winch	G3L 2024 & prior	715006973	\$395.99
	<ul style="list-style-type: none"> Ergonomic clutch handle. Rugged all-steel gears and bushings for more torque and longer life. Automatic 100% load-holding brake. Can be used with the Wireless Winch Remote (715008286) or the Can-Am HD Wired Remote Control (715008121) (sold separately). 	<ul style="list-style-type: none"> Pulling strength capability of 2,500 lb (1,134 kg). 50 ft. of 3/16" (15.2 m of 4.8 mm) wire steel cable. Heavy-duty 4-way roller fairlead. Weather-sealed handlebar-mounted switch. Sealed solenoid for all-weather protection. Plug-and-play wiring. EC and UKCA compliant. 	

Can-Am HD 3500 Winch	G3L 2024 & prior	715006974	\$427.99
-----------------------------	------------------	------------------	-----------------



- Ergonomic clutch handle.
- Rugged all-steel gears and bushings for more torque and longer life.
- Automatic 100% load-holding brake.
- Can be used with the Wireless Winch Remote (715008286) or the Can-Am HD Wired Remote Control (715008121) (sold separately).
- Pulling strength capability of 3,500 lb (1,588 kg).
- 50 ft. of 7/32" (15.2 m of 5.6 mm) wire steel cable.
- Heavy-duty 4-way roller fairlead.
- Weather-sealed handlebar-mounted switch.
- Sealed solenoid for all-weather protection.
- Plug-and-play wiring.
- EC and UKCA compliant.

Can-Am HD 3500-S Winch	G3L 2024 & prior	715008285	\$534.99
-------------------------------	------------------	------------------	-----------------



- Ergonomic clutch handle.
- Rugged all-steel gears and bushings for more torque and longer life.
- Automatic 100% load-holding brake.
- Can be used with the Wireless Winch Remote (715008286) or the Can-Am HD Wired Remote Control (715008121) (sold separately).
- Pulling strength capability of 3,500 lb (1,588 kg).
- 50 ft. of 3/8" (15.2 m of 4.8 mm) synthetic rope.
- Heavy-duty Hawse fairlead.
- Weather-sealed handlebar-mounted switch.
- Sealed solenoid for all-weather protection.
- Plug-and-play wiring.
- EC and UKCA compliant.

Can-Am HD 3500-S Winch	G3 (except X mr models), G3L 2025 & up	715009799	\$534.99
-------------------------------	--	------------------	-----------------



- Ergonomic clutch handle.
- Rugged all-steel gears and bushings for more torque and longer life.
- Automatic 100% load-holding brake.
- Can be used with the Wireless Winch Remote (715008286) or the Can-Am HD Wired Remote Control (715008121) (sold separately).
- Pulling strength capability of 3,500 lb (1,588 kg).
- 50 ft. of 3/8" (15.2 m of 4.8 mm) synthetic rope.
- Heavy-duty Hawse fairlead.
- Weather-sealed handlebar-mounted switch.
- Sealed solenoid for all-weather protection.
- Plug-and-play.
- EC and UKCA compliant.

WINCH ACCESSORIES

NEW X mr Winch Strap Extension for Plow	G3 X mr	715010174	\$21.49
--	---------	------------------	----------------

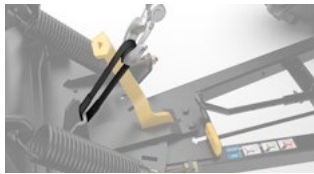

- Heavy-duty black polyester webbing strap with PVC abrasion protection.
- UV, mildew and stretch resistant.
- Provides a physical height limiter to enhanced frame protection avoiding contact between plow pushframe and the vehicle.
- Instantly adds significant length to your winch hook.

NEW Wireless Winch Remote	All Can-Am HD Winches	715008286	\$159.74
----------------------------------	-----------------------	------------------	-----------------



- On/Off and Winch In / Winch Out buttons with LED indicator light.
- Large Winch In / Winch Out buttons for easy activation with gloves.
- Ergonomic remote handle shape with a trigger-like holding protrusion.
- Quick and easy to install, thanks to a wiring harness with an integrated antenna and all necessary mounting hardware.
- Allows you to operate your winch from anywhere within a 50' (15.2 m) radius, increasing your recovery options.
- All components are IP67 sealing rated.
- The remote also floats in case it's dropped during a deep water recovery.
- Dash and handlebar mounting options.
- Compatible with all Can-Am HD winches.

NEW Winch Cable Stopper	All Can-Am HD Winches	715009921	\$21.29
--------------------------------	-----------------------	------------------	----------------



- Made of EPDM, a highly durable synthetic rubber.
- The Winch Cable Stopper isn't just for looks. It helps extend the life of the winch, rope, hook, and fairlead.
- In addition, the split design makes it easy to install.

NEW Winch Harness	G3L (Electric models only)	715009917	\$107.49
--------------------------	----------------------------	------------------	-----------------



- Required to install a winch on a Outlander Electric without a factory installed winch.

Can-Am HD Wired Remote Control	Can-Am HD Winches	715008121	\$32.99
---------------------------------------	-------------------	------------------	----------------



- This kit allows owners to add a handheld remote to their winch or a stock winch.
- Works with the handlebar-mounted switch.
- Wired Remote and Remote Socket included.
- 10 ft. wire.

Winch Accessories Kit		715002409	\$134.49
------------------------------	--	------------------	-----------------



- Get the most out of your winch.
- Double your pulling power, change your pulling direction and keep your winch in proper working order.
- Includes tree straps, snatch block, shackle and winching gloves.

HITCHES

HITCHES

Front Receiver Hitch	G3, G3L	715004977	\$106.49
-----------------------------	---------	------------------	-----------------



- Installs easily. No drilling required.
- This hitch offers a 1,500 lb (680 kg) towing capacity.
- Allows you to maneuver your trailer easily in tight, confined areas.
- Hitch bar sold separately.

Rear Hitch Drawbar Kit	G3, G3L	715006230	\$99.99
-------------------------------	---------	------------------	----------------



- Works on 2" (5 cm) standard receiver hitch.
- Offers a towing capacity of 3.8 kN (R = 750 kg).
- 50 mm Hitch Ball included.
- Forged steel.
- For European vehicles only.

HITCH ACCESSORIES

Rubber Receiver Plug		705204503	\$13.81
-----------------------------	--	------------------	----------------



- Rubber cap for 2" (5 cm) hitch receiver.

PERFORMANCE

PERFORMANCE

NEW Fixed Riser – 1.5 in. (38 mm)	G3 (except X mr, XT-P & Backcountry models), G3L, 6x6 DPS	715009919	\$74.54
--	---	------------------	----------------



- 1.5" (38 mm) height.
- Made of lightweight machined aluminum.
- Black powder coat paint.

NEW Performance Sway Bar Kit	G3 2025 & up (except XT, XT-P, X mr, 6x6 & Limited)	715010580	\$186.49
-------------------------------------	--	------------------	-----------------



- Made of high-strength steel for durability and precision.
- Double bonded rubber bushings on sway bars reduce noise and maintenance and increase durability.
- Includes complete hardware.

NEW Foam Air Filter by TwinAir†	G3L (except Electric models)	715004944	\$159.74
	G3 (except Electric models)	715009125	



- Oiled filtering foam for superior dust retaining capacity with high air flow.
- Washable and reusable.

Snorkel Kit	G3L (except Electric models)	715005073	\$404.49
--------------------	------------------------------	------------------	-----------------



- Comprehensive snorkel kit for extended air intakes and CVT exhaust.
- The CVT outlet integrates into the pod cover.
- Ideal when riding in muddy conditions.
- Not compatible with windshields.
- Can be installed with the Integrated Audio System (715005354).

Radiator Relocator Kit	G3L (except Electric models)	715004943	\$802.49
-------------------------------	------------------------------	------------------	-----------------



- Relocates radiator to top mount position.
- Prevents cooling performance loss in muddy conditions.
- Allows riders to open the relocator hood for easy radiator cleaning.
- Engineered for easy cooling system bleeding and maintenance.
- Includes support, hardware and hoses. Uses existing radiator: radiator not included.

Mud Strap	G3, G3L	715003053	\$50.99
------------------	---------	------------------	----------------



- Convenient sturdy grab-handle.
- Lets drivers redistribute their weight for improved traction in demanding conditions.

Radiator Protector	G3 (except X mr models) G3L (except X mr models)	715005333	\$106.49
---------------------------	---	------------------	-----------------



- Metal shield mounts over radiator face and protects vehicle from stones and branches.
- Easily slides out of its holder for easy cleaning.

Heavy Duty Spring Kits	G3L (except MAX & X mr models)	715008202 - Front 715004942 - Rear	\$159.49
-------------------------------	--------------------------------	---	-----------------



- Allows riders to replicate the standard HD5/HD7 suspension setup on the Outlander 500/700 (1-up).
- The heavy-duty springs improve handling and provide enhanced stiffness, which is perfect for snow clearing and hauling heavy loads.
- Two springs included in the kit.

Aluminum Footpeg Kit	G3, G3L	715008199	\$63.99
-----------------------------	---------	------------------	----------------



- Provides maximum integrated grip and stability during vigorous riding.
- The kick-up end gives riders added grip during hard cornering.
- Made of aluminum, sold in pairs.

EMERGENCY ACCESSORIES

Emergency Kit		715006102	\$170.49
----------------------	--	------------------	-----------------



- Complete emergency kit provides all essential equipment and supplies to get out of most unfavorable situations powersport enthusiasts may find themselves in.
- Includes jumper cables, air compressor, tire-repair kit, first-aid kit, ratchet tie-down, duct tape, 3,300 lb (1,500 kg) tow strap, zip-ties and cloth rags.

COVERS & ADD-ONS

Heavy-Duty Seat Cover	G3 (except MAX models) G3L (except MAX models)	715008311	\$63.99
------------------------------	---	------------------	----------------



- Heavy-duty materials to cover and protect the seat.
- Designed to fit the vehicle's lines perfectly.
- Abrasion- and tear-resistant.
- Easily installed by stretching around the original seat: the elastic holds the cover securely in place.

Heavy-Duty Seat Cover	G3L (MAX models only)	715008313	\$84.99
------------------------------	-----------------------	------------------	----------------

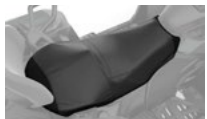

- Heavy-duty materials to cover and protect the seat.
- Designed to fit the vehicle's lines perfectly.
- Abrasion- and tear-resistant.
- Easily installed by stretching around the original seat: the elastic holds the cover securely in place.

NEW Trailering Cover	G3, G3L (except MAX models)	715010578	\$255.49
	G3, G3L (MAX models only)	715010579	



- Weather-resistant trailering cover protects your vehicle during storage and transportation.
- Fuel tank can be accessed via a zip fastener.
- Heavy-duty canvas made of UV-resistant solution-dyed polyester.
- Inner soft liner protects windshield and colored panels from abrasion.
- Quick and easy clip-on installation.
- Designed with the vehicle to fit its lines perfectly for less wind resistance and less water accumulation.
- Can be installed with or without Can-Am accessories.

Flag	 715000277 • Yellow	\$35.99
-------------	---	----------------



- Make sure everyone knows what you're riding.
- Perfect for the dunes and new riders.
- 8-ft. (2.4 m) length.
- Includes Flag Mount (715000127).

Ratchet Tie-Downs	 715008309 • Black/ Gray	\$31.99
--------------------------	---	----------------



- 400 lb (181 kg) safe working load.
- 1" x 10' (2.5 cm x 3 m) strap with Can-Am, Sea-Doo, and Ski-Doo logos.
- Deluxe ratchet with rubber handle.
- Coated S hooks.
- Pack of 2.

Heavy-Duty Ratchet Tie-Down	715008308	\$47.99
------------------------------------	------------------	----------------



- 1,000 lb (454 kg) safe working load.
- 1.5" x 6' (38 mm x 1.8 m) strap with BRP brands.
- Deluxe ratchet with rubber handle.
- Black-coated clip hooks.
- 12" (300 mm) webbing included.
- Pack of two.

No traction? No problem. Apache XC Tracks are built for serious terrain. With improved flotation and stability, they tackle deep snow, mud, and everything in between. Engineered for optimized attack angles, reduced noise, and unmatched durability, this system means all-season dominance.

DESIGNED FOR PEAK PERFORMANCE

Aggressive lugs deliver max traction without sacrificing handling. A reinforced steel frame boosts strength, while the center slide improves alignment and reduces detracking. Reduced NVH levels and the wheel placement ensure smooth, quiet power delivery. Plus, wheel longevity is increased with replaceable wheel bearings.



APACHE TRACK SYSTEMS

APACHE XC AND XC LT			
Apache XC LT Track System	G3 (except 6x6 models) G3L (except 6x6 models)	715007719	\$6,899.99
 <ul style="list-style-type: none"> • Long Track version. • Brand-new track design to optimize driving off and in deep snow conditions. • Reduction in steering effort thanks to the tandem 4 wheels. • Vibrations are reduced due to the alignment of the wheels with the rolling band of the track and the shaft damper mounted tandem. • Better steering precision with this wheel and track alignment due to good ground contact. • 1.25" (3.175 cm) lugs in the front and in the back for better traction and lateral stability. • Track width: front 12.5" and rear 15". • Adds 3" (7.62 cm) of ground clearance versus 27" tires. 	<ul style="list-style-type: none"> • Additional shaft dampers, tandem dampers, track design and wheel layout significantly reduce NVH (noise vibration harshness). • Central guide for optimized track alignment and reduced occurrences of detracking. • Optimized track layout with increased angle of attack for better obstacle crossing and snow performance. • Stamped and welded steel frame for improved strength and durability. • Easy maintenance with replaceable hub and wheel bearings. • Main hub is oil bath with 3 bearings inside for consistent lubrication. • DPS module and engine and CVT pre-filter required. • Mounting kit sold separately. 		

Apache XC Track System	G3 (except 6x6 models)	715008664	\$5,719.99
	G3L (except 6x6 models)		



- Brand-new track design to optimize driving off and in deep snow conditions.
- Reduction in steering effort thanks to the tandem 4 wheels.
- Vibrations are reduced due to the alignment of the wheels with the rolling band of the track and the shaft damper mounted tandem.
- Better steering precision with this wheel and track alignment due to good ground contact.
- 1.25" (3.175 cm) lugs in the front and in the back for better traction and lateral stability.
- Track width: front 12.5" and rear 15".
- Adds 3.25" of ground clearance vs 25" tires.
- Additional shaft dampers, tandem dampers, track design and wheel layout significantly reduce NVH (noise vibration harshness).
- Central guide for optimized track alignment and reduced occurrences of detracking.
- Optimized track layout with increased angle of attack for better obstacle crossing and snow performance.
- Stamped and welded steel frame for improved strength and durability.
- Easy maintenance with replaceable hub and wheel bearings.
- Main hub is oil bath with 3 bearings inside for consistent lubrication.
- DPS module and engine and CVT pre-filter required.
- Mounting kit sold separately.

Apache XC & XC LT Mounting Kit <i>(Not illustrated)</i>	G3 (except 6x6 models)	715008264	\$377.99
	G3L (except 6x6 models)		

- Required for installation of the Apache XC and XC LT Track System.
- Track DPS Module and Pre-Filter not included.

APACHE BACKCOUNTRY

Apache Backcountry Track System	G3 (except 6x6 models)	715005247	\$6,749.99
	G3L (except 6x6 & Electric models)		



- Designed to deliver the best flotation level and deep-snow performance on the market.
- Contact patch is 23% bigger than the Apache 360 LT.
- Impressive added ground clearance of 7" (18 cm), keeps the vehicle out of deep snow.
- Aggressive track design with 2" (5 cm) lug height for maximum traction on snow.
- Apache Backcountry Mounting Kit and engine and air intake pre-filters are required.
- For winter use only.

Apache Backcountry Mounting Kit <i>(Not illustrated)</i>	G3 (except 6x6 models)	715010045	\$701.99
	G3L (except 6x6 & Electric models)		

- Required to install Apache Backcountry Track System.
- DPS module and pre-filter not included.
- Improved installation time and switch seasons faster than ever.

APACHE 360 & 360 LT

Apache 360 Track System	G3L (except 6x6 & Electric models)	715006323	\$5,459.99
--------------------------------	------------------------------------	------------------	-------------------



- Multifunctional tracks perfect for any Can-Am ATV.
- Average ground clearance of 16" (41 cm).
- 1" (2.5 cm) lugs in the front and 1.25" (3.2 cm) in the back.
- Apache 360 and 360 LT Mounting Kit and engine and air intake pre-filters are required.
- EC compliant.

Apache 360 LT Track System	G3L (except 6x6 & Electric models)	715005103	\$6,729.99
-----------------------------------	------------------------------------	------------------	-------------------







- Multifunctional tracks designed to support heavy loads and to fit on most Can-Am Off-Road vehicles.
- Front wheel height adjustment provides enhanced attack angle and better performance over rough terrain when raised or increased contact patch for improved flotation when lowered.
- Average ground clearance of 16" (41 cm).
- 1" (2.5 cm) lugs in the front and 1.25" (3.2 cm) in the back.
- Reliable heavy-duty build.
- EC compliant.
- Contact patch is 7 to 9% bigger than the Apache 360's.
- Apache 360 and 360 LT Mounting Kit, Track DPS Module and Engine and Air Intake Pre-filters are required.

Apache 360 & 360 LT Mounting Kit <i>(Not illustrated)</i>	G3L (except 6x6 & Electric models)	715004992	\$431.49

- Required to install Apache 360 and 360 LT Track Systems.
- DPS module and pre-filter not included.
- Improved installation time and switch seasons faster than ever.

APACHE TRACK SYSTEM ACCESSORIES

Track DPS Module <i>(Not illustrated)</i>	G3 (without iTC)	715007338	\$111.49
	G3L (without iTC) (except Electric models)		
	G3 (with iTC)	715006266	\$111.49
	G3L (with iTC)		
<ul style="list-style-type: none"> • An innovative DPS module that ensures speedometer accuracy and optimized steering assist, which make for perfect track control and riding ease. • Required to install the Apache and Backcountry Track Systems. 			
Air Intake Engine Pre-filter	G3 G3L (except Electric models)	715008314	\$42.49
	<ul style="list-style-type: none"> • Adds extra protection for your engine in harsh riding conditions. • The filter blocks particles larger than 0.005". • Necessary when tracks are installed. 		
Idler Wheel Kit	Apache Backcountry Track System (rear tracks only)	860201230 • 141 mm	\$62.49
	<ul style="list-style-type: none"> • Reduces drag and rolling resistance. • Includes 2 wheels, brackets and hardware. • Add up to 2 kits per rear track. • Can extend slider life in hardened snow conditions. 		
Sliders with Vespel [†] Inserts	Apache Backcountry Track System	503194815	\$148.49
	<ul style="list-style-type: none"> • Use DuPont Vespel inserts for less friction. • Longer life. • Can be cut to desired length. • 8 needed per vehicle. • Sold individually. 		
Rail Ice Scratchers	Apache Backcountry Track System	860201728	\$127.99
	<ul style="list-style-type: none"> • Provide additional lubrication in hard and icy conditions. • Rail mounted, small, light. • Design expands on coil concept to allow reversing without damage. • Easily stored when not in use. 		

APACHE TRACK SYSTEMS FITTING GUIDE

APACHE BACKCOUNTRY

Model Year / Model	Track	Track Mount	Track DPS Module	Engine Pre-filter	CVT Pre-filter
2023 & Up	G3L	715010045	715007338 (without iTC) OR 715006266 (with iTC)	715008314 (except Electric models)	Not required
	G3				

APACHE XC AND XC LT

Model Year / Model	Track	Track Mount	Track DPS Module	Engine Pre-filter	CVT Pre-filter
2023 & Up	G3L	715008264	715006266 (with iTC) OR 715007338 (without iTC)	715008314 (except Electric models)	Not required
	G3				

APACHE 360 AND APACHE 360 LT

Model Year / Model	Track	Track Mount	Track DPS Module	Engine Pre-filter	CVT Pre-filter
2023 & Up	G3L	715004992	715007338 (without iTC) OR 715006266 (with iTC)	715008314	Not required

The Outlander G3 and G3L plows are tough on snow and easy to install. With ProMount Mounting Pins, there's no drilling, no guesswork. Just a clean fit that stays on year-round without sacrificing ground clearance. Quick to set up, built to push hard.

BUILD A KIT THAT WORKS HARD.

Combine a mounting kit, push frame, and blade. Then, customize with accessories like the plow angling kit, blade extensions, or edge markers. Easy to install, engineered to last, and tough enough for brutal winter jobs—this lineup covers every plowing need.



PROMOUNT PLOWS

PROMOUNT PLOW KITS

STEEL – REFERENCE CHART

	54" Black Steel	60" Black Steel	66" Black Steel	72" Black Steel
Plow Kit	715011002	715011003	715011004	—
Blade	715004472	715004202	715009881	715009877
Push Frame	715010845	715010845	715010845	715010845
Mounting Kit	715009483	715009483	715009483	715009483

FLEX2 – REFERENCE CHART

	60" Flex2	66" Flex2	72" Flex2
Plow Kit	715011005	715011006	—
Blade	715004203	715009883	715009868
Push Frame	715010845	715010845	715010845
Mounting Plate	715009483	715009483	715009483

STEEL PLOWS

Can-Am ProMount 54" (137 cm) Steel Plow Kit	G3, G3L	■ 715011002 • Black	N/A
	This kit includes: - Can-Am ProMount Steel Blade - Push Frame with Quick-Attach System - Mounting Kit - Plow Roller Fairlead		
Can-Am ProMount 60" (152 cm) Steel Plow Kit	G3, G3L	■ 715011003 • Black	N/A
	This kit includes: - Can-Am ProMount Steel Blade - Push Frame with Quick-Attach System - Mounting Kit - Plow Roller Fairlead		
Can-Am ProMount 66" (168 cm) Steel Plow Kit	G3, G3L	■ 715011004 • Black	N/A
	This kit includes: - Can-Am ProMount Steel Blade - Push Frame with Quick-Attach System - Mounting Kit - Plow Roller Fairlead		
Can-Am ProMount Steel Blades 54" (137 cm) Blade	Fits ProMount Push Frame	■ 715004472 • Black	\$384.99
	<ul style="list-style-type: none"> • Blades available individually to create your own kit. • Compatible with Can-Am ProMount Blade accessories to further enhance plow versatility (some plow accessories are not compatible with 54" (137 cm) plows). • Not compatible with ProMount Drift Cutters, Blade Extensions and Edge Markers. • Clears 50" (127 cm) when plow is fully angled. • Blade height of 14.75" (37 cm). 		
Can-Am ProMount Steel Blades 60" (152 cm) Blade	Fits ProMount Push Frame	■ 715004202 • Black	\$417.49
	<ul style="list-style-type: none"> • Blades available individually to create your own kit. • Compatible with Can-Am ProMount Blade accessories to further enhance plow versatility. • Clears 54" (137 cm) when plow is fully angled. • Blade height of 17" (43 cm). 		
Can-Am ProMount Steel Blades 66" (168 cm) Blade	Fits ProMount Push Frame	■ 715009881 Black	\$534.99
	<ul style="list-style-type: none"> • Now with an improved shoe design for better flotation with an easy and quick tool-free adjustment. • Plow blade made from 12-gauge steel. • Replaceable wear blade. • Large pin designed for easy blade rotation to eliminate snow buildup at pivot point. • Blade design provides best snow roll-off at any angle. • Clears 60" (152 cm) when plow is fully angled. • Blade height of 17" (43 cm). • Compatible with Can-Am ProMount Blade accessories to further enhance plow versatility. 		
Can-Am ProMount Steel Blades 72" (183 cm) Blade	Fits ProMount Push Frame	■ 715009877 • Black	\$609.99
	<ul style="list-style-type: none"> • Now with an improved shoe design for better flotation with an easy and quick tool-free adjustment. • Plow blade made from 12-gauge steel. • Replaceable wear blade. • Large pin designed for easy blade rotation to eliminate snow buildup at pivot point. • Blade design provides best snow roll-off at any angle. • Clears 66" (168 cm) when plow is fully angled. • Blade height of 17" (43 cm). Compatible with Can-Am ProMount Blade accessories to further enhance plow versatility. 		

CAN-AM ProMount FLEX2 PLOW KIT

Can-Am ProMount 60" (152 cm) Flex2 Plow Kit	G3, G3L	■ 715011005 • Black	N/A
--	---------	---------------------	-----



- This kit includes:
- Can-Am ProMount Flex2 Blade
 - Push Frame with Quick-Attach System
 - Mounting Kit
 - Plow Roller Fairlead

Can-Am ProMount 66" (168 cm) Flex2 Plow Kit	G3, G3L	■ 715011006 • Black	N/A
--	---------	---------------------	-----



- This kit includes:
- Can-Am ProMount Flex2 Blade
 - Push Frame with Quick-Attach System
 - Mounting Kit
 - Plow Roller Fairlead

CAN-AM ProMount FLEX2 PLOWS

Can-Am ProMount Flex2 60" (152 cm) Blade	Fits ProMount Push Frame	715004203	\$524.49
---	--------------------------	-----------	----------



- Plow blade made of UHMWPE, a flexible and impact absorbing material that prevents damage to your plow when accidental impacts occur.
- Replaceable wear blade.
- Large pin designed for easy blade rotation to eliminate snow buildup at pivot point.
- Blade design provides best snow roll-off at any angle.
- Compatible with Can-Am ProMount Blade accessories to further enhance plow versatility.
- Clears 54" (137 cm) when plow is fully angled.
- Blade height of 17" (43 cm).

Can-Am ProMount Flex2 66" (168 cm) Blade	Fits ProMount Push Frame	715009883	\$598.99
---	--------------------------	-----------	----------



- Now with an improved shoe design for better flotation with an easy and quick tool-free adjustment.
- Plow blade made of UHMWPE, a flexible and impact absorbing material that prevents damaging to your plow when accidental impact occurs.
- Replaceable wear blade.
- Large pin designed for easy blade rotation to eliminate snow buildup at pivot point. Blade design provides best snow roll-off at any angle.
- Clears 60" (152 cm) when plow is fully angled.
- Blade height of 17" (43 cm).
- Compatible with Can-Am ProMount Blade accessories to further enhance plow versatility.

Can-Am ProMount Flex2 72" (183 cm) Blade	Fits ProMount Push Frame	715009868	\$684.99
---	--------------------------	-----------	----------



- Now with an improved shoe design for better flotation with an easy and quick tool-free adjustment.
- Plow blade made of UHMWPE, a flexible and impact absorbing material that prevents damage to your plow when accidental impacts occur.
- Replaceable wear blade.
- Large pin designed for easy blade rotation to eliminate snow buildup at pivot point.
- Blade design provides best snow roll-off at any angle.
- Compatible with Can-Am ProMount Blade accessories to further enhance plow versatility.
- Clears 66" (168 cm) when plow is fully angled.
- Blade height of 17" (43 cm).

ANGLE PLOWS

Can-Am ProMount Angle Blades 60" (152 cm) Steel Oneway State Blade	G3, G3L	715007261	\$556.49
---	---------	-----------	----------



- Make the job easier with the right tools, clear long alleys and make the task easier by sending the snow further out of the way.
- Wing end of plow measures 25" (63 cm) high and tapers down to 17" (43 cm).
- One-way "winged" state plow designed to throw snow higher.
- Rubber Flap (715007299) designed to keep snow away from the driver is offered as accessory (sold separately).
- Can-Am branded.

Can-Am ProMount Angle Blades 72" (183 cm) Steel Oneway State Blade	G3, G3L	715009879	\$705.99
---	---------	-----------	----------



- Now with an improved shoe design for better flotation with an easy and quick tool-free adjustment.
- Wing end of plow measures 26" (67 cm) high and tapers down to 17" (43 cm).
- One-way "winged" state plow designed to throw snow higher.
- Rubber Flap (715007299) designed to keep snow away from the driver is offered as accessory (sold separately).
- Can-Am branded.

ProMount One-Way State Blade Rubber Flap
(Not illustrated)

715007299

\$128.49

- Allows for more efficient snow projections in various snow conditions.

CAN-AM ProMount PLOW ACCESSORIES

Can-Am ProMount Push Frame with Quick-Attach System

G3, G3L

715010845

\$534.99



- Heavy-duty steel tubes designed to withstand the roughest use.
- Mount location provides the ultimate push strength and traction.
- Designed for maximum plow lift height.
- Features a self-aligning quick-attach system, an easy foot-release pedal and an ergonomic handle for plow angle adjustment.
- Allows blade to swivel left or right in five positions.
- Compatible with all Can-Am ProMount blades.
- Plow Roller Fairlead and Plow Limit Switch recommended to extend winch cable lifespan.
- Can-Am ProMount Mounting Kit required for installation.
- G3 X mr models: Require X mr Winch Strap Extension for Plow (715010174).

NEW Can-Am ProMount Plow Angling System

G3, G3L

715010904

\$695.49

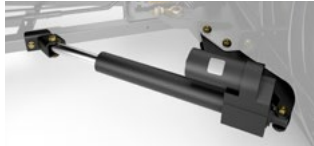

- Converts your plow system into an easy-to-control unit from the driver's seat.
- Using one hand to control all plow motions will allow you to easily concentrate and manage your plowing tasks.
- Compatible with ProMount Blade.
- Push Frame (715010845) is required.
- Push Frame Extension (715006257) is required for installation with the Front Rancher Bumper.
- Winch and plow sold separately.
- Not compatible with Apache Backcountry LT Track System.

Can-Am ProMount Push Frame Extension

G3, G3L

715006257

\$186.99



- 12" (30 cm) push frame extension.
- Required when plow is installed with Apache Track System.

Can-Am ProMount Mounting Kit

G3, G3L

715009483

\$128.49



- Required to install the Can-Am ProMount Push Frame with Quick-Attach System.
- 20 mm mounting rods are designed to stay in place all year round without compromising on ground clearance.
- No drilling required.
- Quick installation directly to the chassis.
- Plow Roller Fairlead included.

NEW Plow Quick Adjust Blade Shoes

ProMount Steel & Flex2 Blades 54" & 60" (all years), 66" & 72" (2025 & prior)

715009751

\$106.99



- Zinc-plated steel construction for corrosion resistance.
- Easy and quick tool-free adjustment.
- Pre-set adjustment for different heights.
- Larger shoe diameter for greater ground contact.
- Improved shoe design for better flotation.

NEW X mr Winch Strap Extension for Plow

G3 X mr

715010174

\$21.49



- Heavy-duty black polyester webbing strap with PVC abrasion protection.
- UV, mildew and stretch resistant.
- Provides a physical height limiter for enhanced frame protection, avoiding contact between plow pushframe and the vehicle.
- Instantly adds significant length to your winch hook.

Can-Am ProMount Edge Markers

G3, G3L

715004206

\$48.99



- Help locate the edges of your plow.
- Height: 24" (60 cm).
- Sold in pairs.
- Compatible with Can-Am ProMount Steel and Flex2 Blades with or without Blade Extensions (except for the Can-Am ProMount Steel 54" (137 cm) Blades).

Can-Am ProMount Drift Cutters	G3, G3L	715006258	\$170.99
--------------------------------------	---------	------------------	-----------------



- Help keep snow in the plow.
- Dimensions: 17" x 13" (43.2 cm x 33 cm).
- Sold in pairs.
- Compatible with Can-Am ProMount Steel and Flex2 Blades with or without Blade Extensions (except for the Can-Am ProMount Steel 54" (137 cm) Blades).

Can-Am ProMount Plastic Wear Blade	G3, G3L	715004480 • 54" (137 cm)	\$149.99
		715004481 • 60" (152 cm)	\$170.99
		715004482 • 66" (168 cm)	\$192.49



- To help prevent scratches on smooth driveways and markable surfaces.

Can-Am ProMount Curved Wear Blade	G3, G3L	715007791 • 60" (152 cm)	\$122.99
		715007792 • 66" (168 cm)	
		715007793 • 72" (183 cm)	



- Wear blade designed with a folded back bottom lip.
- The increased surface allows for less digging while plowing uneven surfaces.
- Ideal for snow covered gravel, grass, paver stone and other soft surfaces.

Can-Am ProMount Plow Blade Extensions	G3, G3L	■ 715004205 • Black	\$128.49
--	---------	----------------------------	-----------------



- Add 3" (8 cm) each side.
- Longer Wear Blade can be installed to further extend the extra length already provided by the extensions.
- Compatible with Can-Am ProMount Steel and Flex2 Blades (except for the Can-Am ProMount Steel 54" (137 cm) Blades).

Back Drag Blade	ProMount Plows (60" and more)	715007794	\$299.49
------------------------	-------------------------------	------------------	-----------------



- ¼" thick steel swivel scraper.
- Lifts up when the vehicle is moving forward so as not to affect the scraping.
- Increased capacity to pull snow.
- More aggressive scraping in reverse mode.
- Lifts the blade off the ground so that it scrapes evenly.
- Adjustable in length for compatibility with 60", 66" and 72" blades.
- Compatible with ProMount blades (Flex and Steel).

Plow Roller Fairlead	G3, G3L	705009222	\$74.49
-----------------------------	---------	------------------	----------------



- Larger diameter lower roller reduces wear on wire rope for plow application.
- Can be used with all ProMount plows.
- Included in the Can-Am ProMount Mounting Kit (715009483).

Pulley Kit for Alpine Super-Duty Plow	G3, G3L	715000279	\$61.99
--	---------	------------------	----------------



- Pulley kit to be used in conjunction with the winch when using a snow plow.
- Recommended to increase winch efficiency.
- To be used with the XT Front Bumper.

Plow Limit Switch <i>(Not illustrated)</i>	G3, G3L	715006319	\$143.49
--	---------	------------------	-----------------

- To control the cable tension when raising your plow system.
- Prevents winch, plow push frame and vehicle damage.

Synthetic Winch Cable for Plowing		715000540	\$47.99
--	--	------------------	----------------



- Specially designed for plowing applications.
- 8' (2.4 m) section of durable, extra-strong synthetic rope.
- Stands up to repeated, sharp angle pulls used to lift heavy plow blades.
- Temporarily replace your winch rope for plow season to save wear and tear on wire rope.

PARTS AND MAINTENANCE



PARTS AND MAINTENANCE

How to use the EPC	96
Keep an Eye on These Parts	97
Air Filters	99
Oil Filters	99
Batteries	100
Spark Plugs	100
Axles	102
Ball Joints	104
Brakes	105
Drive belts	105
XPS Tires	108
Lubricant & Oil Change Kit	110
Maintenance Products	111
Care Products	113





OUTLANDER

CAN-AM

ELECTRONIC PARTS CATALOG (EPC)

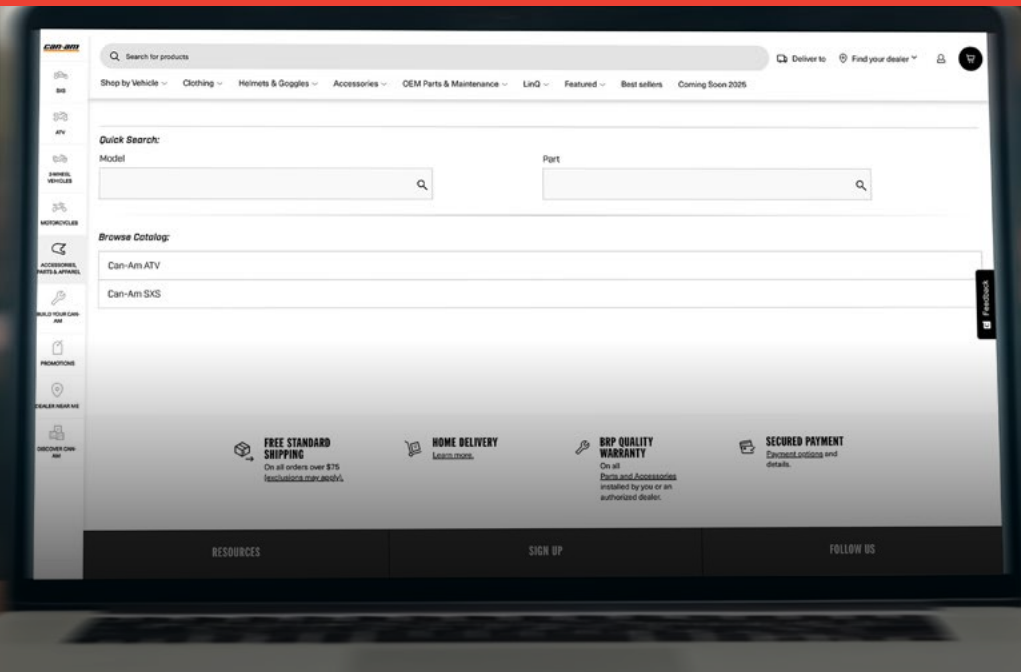

MAKES IT EASY TO LOCATE, IDENTIFY, AND ORDER EXACT-FIT PARTS. IT'S THE GO-TO RESOURCE FOR VIEWING THE FULL CAN-AM PART LINEUP, BUILT TO SAVE TIME AND ELIMINATE GUESSWORK.

3 SIMPLE STEPS TO FIND THE RIGHT PART

1

Select the exact vehicle model.

2

Choose the vehicle system needing a part.

3

Pick the part and add it to the cart. Search by part number or browse the full catalog.



SCAN THE QR CODE FOR INSTANT ACCESS TO THE EPC ON ECOM.

CAN-AM ATVs G2, G2L, G2S



To make sure your ATV performs as you expect,
keep an eye on these components.**

OIL FILTER		420256188
ENGINE OIL		
4T 10W-50 Synthetic Oil	1 quart / 946 ml	9779234
	1 US gallon / 3.785 L	9779235
4T 0W-40 Synthetic Oil	1 quart / 946 ml	9779139
	1 US gallon / 3.785 L	9779140
4t 5W-40 Full Synthetic Oil	1 quart / 946 ml	9779492
	1 US gallon / 3.785 L	9779493
OIL CHANGE KIT		
5W-40 Synthetic Oil	500 cc or more V-twin engine	9779488
0W-40 Synthetic Oil	500 cc or more V-twin engine	9779259
10W-50 Synthetic Oil	500 cc or more V-twin engine	9779252
5W-40 Synthetic Oil	450 cc or less	9779487
0W-40 Synthetic Oil	450 cc or less	9779257
EMISSION CONTROL		
Fuel Tank Vent Breather Filter	Non EVAP models	709001120
Canister Vent Pre-filter	CARB and EVAP models	709001109
AIR FILTER		
Performance Air Filter by Twin Air [†]		715001333
Premium Air Filter		707800371
CVT AIR FILTER		706600416
G2S		707001786
G2, G2L		715003483
DRIVE BELT		
450 cc		422280283
500 cc & more		422280366

BRAKE PADS		
Front & Rear Left	Metallic G2	715900248
Front & Rear Right	Metallic G2	715900249
Front & Rear Left	Organic G2, G2L, G2S (except X mr models)	715601015
Front & Rear Right	Organic G2, G2L, G2S (except X mr models)	715601014
CV BOOT KITS		
Front Wheel Side	G2, G2L, G2S (except X mr models)	705401345
Front Differential Side	G2, G2L, G2S (except X mr models)	705401346
Rear	G2, G2L, G2S (except X mr models)	705501864
Front Wheel Side	X mr models	705401354
Front Differential Side	X mr models	705401355
Rear	X mr models	705501864
WHEEL BEARINGS		293350150
FRONT A-ARM BUSHING KIT		703500875
BALL JOINTS		
Lower		703501262
Upper		703501264
SPARK PLUG		
450, 850, 1000R engines		715900352
570, 650, 1000 engines		715900642
BATTERY		
18 Ah Yuasa YTX20L, fact. activated		410301203

**Refer to periodic maintenance chart for proper intervals.

CAN-AM ATVs G3, G3L



To make sure your ATV performs as you expect,
keep an eye on these components.**

OIL FILTER 420256188

OIL FILTER COVER O-RING 420230922

DRAIN PLUG SEALING RING 420552280

ENGINE OIL

4T 10W-50 Synthetic Oil 1 quart / 946 ml 9779234
1 US gallon / 3.785 L 9779235

4T 0W-40 Synthetic Oil 1 quart / 946 ml 9779139
1 US gallon / 3.785 L 9779140

4T 5W-40 Full Synthetic Oil 1 quart / 946 ml 9779492
1 US gallon / 3.785 L 9779493

OIL CHANGE KIT

5W-40 Synthetic Oil 500 cc or more V-twin engine 9779488

5W-40 Synthetic Oil ACE 650 cc Single cylinder 9779480

0W-40 Synthetic Oil 500 cc or more V-twin engine 9779259

0W-40 Synthetic Oil ACE 650 cc Single cylinder 9779481

10W-50 Synthetic Oil 500 cc or more V-twin engine 9779252

EMISSION CONTROL

Fuel Tank Vent Breather Filter Non EVAP models 709001120

Canister Vent Pre-filter CARB and EVAP models 709001109

AIR FILTER

G3 703501249

G3L 703501247

DRIVE BELT

G3L 500 cc 422280226

G3, G3L 700 cc and more 422280225

PDRIVE MAINTENANCE KITS

Torque Rollers Maintenance Kit 420629224

Ramp Rollers Maintenance Kit 420629237

METALLIC BRAKE PAD

Left/Right Brake Pad Kit* (4 pads per kit/hardware included) *Fits front/rear on all G3 1000 and 850 Xmr, and front on G3L. 705602167

Rear Brake Pad Kit** (2 pads per kit/hardware included) **Fits rear on all G3 850 except Xmr, and G3L. 705602168

CV BOOT KITS

Front CV Outer Boot Kit G3 850, G3L 715500456

Front CV Inner Boot Kit G3 850, G3L 715500457

Rear CV Outer Boot Kit G3 850, G3L 715500464

Rear CV Inner Boot Kit G3 850, G3L 715500465

WHEEL BEARINGS 293350150

BALL JOINTS

Lower 703501262

Upper 703501264

SPARK PLUG 715900785

BATTERY

20 Ah, fact. activated G3 715900973

18 Ah Yuasa YTX20L G3L 410301203

**Refer to periodic maintenance chart for proper intervals.

Can-Am air filters are built for harsh conditions, delivering superior filtration without choking performance. Made to meet exact specs and protect engines from dust, mud, and debris, they're the first line of defense when the ride gets rough.

BUILT STRONG. FILTERS SMARTER.

Each filter features high-density pleated media for maximum dirt-holding capacity, a molded seal for tight fit, and durable construction to prevent collapse in extreme conditions. Engineered to work in sync with Can-Am engines—no guesswork, no compromise.



AIR FILTERS

Premium Air Filter



- Premium quality filter.
- Prevents airborne contaminants from reaching your engine.
- Protects internal components against premature wear.

Models

G3, all packages, 2025-2026	703501249	\$51.99
G3L 2023-2026	703501247	\$51.99
G2, G2L, G2S 2011-2026	707800371	\$40.99

OIL FILTERS

Oil Filters



Models	Oil Filter	
G2, G2L, G2S, G3 & G3L	420256188	\$13.77

BATTERIES

Batteries	Models	BRP#	TYPE	AMP-HOURS	
	G3	715900973	FACTORY ACTIVATED	20	N/A
	G3L	410301203	YUASA YTX20L, FACT. ACTIVATED	18	N/A
	G2, G2L, G2S	410301203	YUASA YTX20L, FACT. ACTIVATED	18	N/A
	DS 70/90	V31500MAA020	FACTORY ACTIVATED	6	N/A
	DS 250	715900710	YUASA YTX12, FACT. ACTIVATED	10	N/A
	DS 450	715500305	YUASA YT7B-BS	6.5	N/A
	RENEGADE 70/110	V31500MAA020	FACTORY ACTIVATED	6	N/A

SPARK PLUGS

Spark Plugs	Models		
	G3, G3L (all engines)	715900785	\$21.99
	G2, G2L, G2S (450, 850, 1000R)	715900352	\$21.99
	G2, G2L, G2S (570, 650, 1000)	715900642	\$6.35
	DS 70/90	219703175	\$4.23
	DS 250	219703176	\$10.59
	DS 450	278002297	\$6.35
	DS 650/Traxter	707000008	\$4.23
Renegade 70/110	A9807639A00A	\$14.83	

CAN-AM AXLES ARE ENGINEERED TO EXACT TOLERANCES, TESTED TO ENDURE EXTREME LOADS, AND BUILT WITH HIGH-GRADE MATERIALS TO HANDLE HEAT, FLEX, AND ABUSE WITHOUT COMPROMISE.

Genuine Can-Am axles perfectly match drive train, steering, and suspension geometries to reduce steering effort, premature wear, and unwanted loads on components such as ball joints, tie-rods, and bearings.

Can-Am axles do more than just transmit power. They protect your ride with carefully engineered thresholds, absorbing stress to protect the rest of your drive train.

Every Can-Am axle is precision-machined, heat-treated chromium and molybdenum alloy steel, combined with TPE CV boots and friction- and heat-reducing grease, resulting in longer joint life.



HOLD THE POWER. TAKE THE HIT.

Axles act as pressure points in the power system, absorbing stress to help protect more complex and costly components. No weak links. Just smart engineering.



AXLES

Model / Package / Engine*	Years	Front				Rear				
		Right Axle	Left Axle	Boot (diff. side)	Boot (wheel side)	Right Axle	Left Axle	Boot (diff. side)	Boot (wheel side)	
G3L										
Base / DPS / XT / Pro (incl. MAX models)	Base & DPS 500 Pro & Pro XU HD5 Base, DPS & XT 700 Pro & Pro XU HD7	2023–2024	705402250	705402251	715500457	715500456	705502928		715500465	715500464
	Base & DPS 500 Pro & Pro XU HD5 Base, DPS & XT 700 Pro & Pro XU HD7	2025–2026	705402250	705402251	715500457	715500456	705503679		715500465	715500464
XMR	XMR 700	2023–2024	705402250	705402251	715500457	715500456	705502928		715500465	715500464
	XMR 700	2025–2026	705402250	705402251	715500457	715500456	705503679		715500465	715500464
EV	Electric	2026	705402250	705402251	715500457	715500456	705503679		715500465	715500464
6X6										
							2nd (middle)	3rd (rear)		
	6x6 DPS 700	2026	705402250	705402251	715500457	715500456	705503679		715500465	715500464
G3										
DPS / XT / XTP / LTD (Including MAX models)	DPS 1000 DPS 1000R	2025–2026	705403312	705403313	715500528	715500464	705503459		715500532	715500531
	XT 1000 XT 1000R	2025–2026	705403312	705403313	715500528	715500464	705503459		715500532	715500531
	XTP 1000 XTP 1000R	2025–2026	705403312	705403313	715500528	715500464	705503459		715500532	715500531
	LTD 1000 LTD 1000R	2025–2026	705403312	705403313	715500528	715500464	705503459		715500532	715500531
XMR	XMR 850 XMR 1000 & 1000R Backcountry 1000R	2025–2026	705403316	705403317	715500530	715500529	705503461		715500532	715500531
Base / DPS / XT (incl. MAX)	Base, DPS & XT 850	2025–2026	705403561	705403562	715500457	715500456	705503679		715500465	715500464
6x6 (inc. MAX)										
							2nd (middle)	3rd (rear)		
	6x6 Backcountry 1000R	2026	705403316	705403317	715500530	715500529	705503461		715500532	715500531
	6x6 DPS 850	2026	705403561	705403562	715500457	715500456	705503679		715500465	715500464
G2L										
Base / DPS / XT / STD+ / Mossy Oak (incl. MAX models)	Base 450 DPS 450	2015–2023	705401428	705401429	715900299	715900298	705501897	705501898	705401346	705401345
	Mossy Oak 450	2021–2023	705401428	705401429	715900299	715900298	705501897	705501898	705401346	705401345
	STD+ 450	2022	705401428	705401429	715900299	715900298	705501897	705501898	705401346	705401345
	Base 500 DPS 500	2015	705401428	705401429	715900299	715900298	705501897	705501898	705401346	705401345
	Base 570 DPS 570	2016–2023	705401428	705401429	715900299	715900298	705501897	705501898	705401346	705401345
	Mossy Oak 570	2016–2023	705401428	705401429	715900299	715900298	705501897	705501898	705401346	705401345
	XT 570	2017–2023	705401428	705401429	715900299	715900298	705501897	705501898	705401346	705401345
	STD+ 570	2022	705401428	705401429	715900299	715900298	705501897	705501898	705401346	705401345
XMR/MR	2016 - 2023	705401116	705401115	705401346	705401345	705501486	705501485	705401346	705401345	705501864
	2022 - 2023	705401116	705401115	705401346	705401345	705501486	705501485	705401346	705401345	705501864
6x6 (incl. MAX models)										
							2nd (middle)	3rd (rear)		
	6x6 DPS 450	2019–2024	705401428	705401429	715900299	715900298	705501897	705501898	705401346	705401345
							Right 3rd	Left 3rd		
							705501898	705501897		
G2 / G2S										
Base / DPS / XT / XXC / XTP / LTD / Mossy Oak / Winter (incl. MAX models)	Base, DPS, XT 650	2015–2018	705401116	705401115	705401346	705401345	705501486	705501485	705401346	705401345
	Base, DPS, XT, XXC & XTP 800R	2015	705401116	705401115	705401346	705401345	705501486	705501485	705401346	705401345
	Base, DPS, XT, XXC, XTP & LTD 1000	2015–2018	705401116	705401115	705401346	705401345	705501486	705501485	705401346	705401345
	Base, DPS, XT, XXC & XTP 850	2016–2018	705401116	705401115	705401346	705401345	705501486	705501485	705401346	705401345
	Mossy Oak 850	2017	705401116	705401115	705401346	705401345	705501486	705501485	705401346	705401345
	Mossy Oak 1000R	2017–2018	705401116	705401115	705401346	705401345	705501486	705501485	705401346	705401345
	Winter Edition 650	2018	705401116	705401115	705401346	705401345	705501486	705501485	705401346	705401345
	Winter Edition 850	2018	705401116	705401115	705401346	705401345	705501486	705501485	705401346	705401345
Base / DPS / XT (incl. MAX models)	Base, DPS & XT 500	2015	705401428	705401429	715900299	715900298	705501486	705501485	705501864	705501864
	DPS & XT 570	2016	705401428	705401429	715900299	715900298	705501486	705501485	705501864	705501864
	Base 570	2016–2018	705401428	705401429	715900299	715900298	705501486	705501485	705501864	705501864
	DPS & XT 570	2018	705401428	705401429	715900299	715900298	705501486	705501485	705501864	705501864
XMR	XMR 650	2015–2018	705401703	705401704	705401355	705401354	705501848	705501847	705501864	705501864
	XMR 800R	2015	705401703	705401704	705401355	705401354	705501848	705501847	705501864	705501864
	XMR 1000	2015	705401703	705401704	705401355	705401354	705501848	705501847	705501864	705501864
	XMR 1000R	2016–2018	705401703	705401704	705401355	705401354	705501848	705501847	705501864	705501864
	XMR 650	2019–2026	705402238	705403009	705401355	705401354	705503024	705503025	705501864	705501864
	XMR 850	2019–2024	705402238	705403009	705401355	705401354	705503024	705503025	705501864	705501864
	XMR 1000R	2019–2026	705402238	705403009	705401355	705401354	705503024	705503025	705501864	705501864

AXLES

Model / Package / Engine*	Years	Front				Rear					
		Right Axle	Left Axle	Boot (diff. side)	Boot (wheel side)	Right Axle	Left Axle	Boot (diff. side)	Boot (wheel side)		
G2 / G2S (continued)											
Base / DPS / XT / XTP / XXC / XMR / Winter, North, Mossy Oak & Hunting Editions (inc. MAX)	Renegade 570	2019–2022	705402236	705402235	705401346	705401345	705502711	705502710	705501864	705501864	
	Renegade XMR 570	2019–2021	705402236	705402235	705401346	705401345	705502711	705502710	705501864	705501864	
	DPS & XT 650	2019–2022	705402236	705402235	705401346	705401345	705502711	705502710	705501864	705501864	
	Base 650	2019–2025	705402236	705402235	705401346	705401345	705502711	705502710	705501864	705501864	
	Winter Edition 650	2019	705402236	705402235	705401346	705401345	705502711	705502710	705501864	705501864	
	Mossy Oak 650	2020–2022	705402236	705402235	705401346	705401345	705502711	705502710	705501864	705501864	
	Winter Edition 850	2019	705402236	705402235	705401346	705401345	705502711	705502710	705501864	705501864	
	XXC 850	2019–2022	705402236	705402235	705401346	705401345	705502711	705502710	705501864	705501864	
	Base, DPS, XT, XTP 850	2019–2024	705402236	705402235	705401346	705401345	705502711	705502710	705501864	705501864	
	North Edition 850	2020–2021	705402236	705402235	705401346	705401345	705502711	705502710	705501864	705501864	
	Hunting Edition 850	2023–2024	705402236	705402235	705401346	705401345	705502711	705502710	705501864	705501864	
	Base & DPS 1000R	2019	705402236	705402235	705401346	705401345	705502711	705502710	705501864	705501864	
	Mossy Oak 1000R	2019	705402236	705402235	705401346	705401345	705502711	705502710	705501864	705501864	
	XT, XTP & LTD 1000R	2019–2024	705402236	705402235	705401346	705401345	705502711	705502710	705501864	705501864	
	XXC 1000R	2019–2026	705402236	705402235	705401346	705401345	705502711	705502710	705501864	705501864	
6x6 (inc. MAX models)							2nd (middle)	3rd (rear)			
	6x6 XT 650	2015–2016	705401116	705401115	705401346	705401345	705501486	705501485	705401346	705401345	
	6x6 DPS 650	2017–2018	705401116	705401115	705401346	705401345	705501486	705501485	705401346	705401345	
	6x6 XT 1000	2015–2018	705401116	705401115	705401346	705401345	705501486	705501485	705401346	705401345	
	6x6 DPS 650	2019–2025	705402236	705402235	705401346	705401345	705502711	705502710	705501864	705501864	
	6x6 XT 1000	2019–2025	705402236	705402235	705401346	705401345	705502711	705502710	705501864	705501864	
								Right 3rd	Left 3rd		
	6x6 XT 650							705501485	705501486		
	6x6 DPS 650							705501485	705501486		
	6x6 XT 1000							705501485	705501486		
	6x6 DPS 650							705502710	705502711		
6x6 XT 1000							705502710	705502711			

BALL JOINTS

Suspension Arm Ball Joint with Hardware	Upper All models & packages 2015-2026	703501264	\$36.99
	Lower All models & packages 2015-2026	703501262	\$36.99

• Robust design for off-road usage and sealed for prolonged durability.



Strength, stability, and control. Can-Am A-arms and ball joints are built to keep the suspension locked in and tires planted. Engineered for max articulation, impact resistance, and durability in brutal terrain, they help keep machines running and riders moving.

MADE TO FLEX. BUILT TO HOLD.

High-strength ball joints absorb punishing hits and deliver full-angle movement without binding. Superior sealing and lubrication keep dirt out and performance in. Designed to maintain contact with the ground, because traction means control, and control means confidence.



These are the same high-performance pads installed at the factory, now available in complete kits for quick, full replacements. Engineered with Can-Am, in collaboration with Brembo, to deliver consistent stopping power, even in the toughest off-road conditions.

BUILT FOR BRUTAL STOPS

These pads are optimized for off-road abuse, built to handle heat, grit, and repeat impact. Every kit includes the right components for a full pad swap, with stopping power that never backs down.

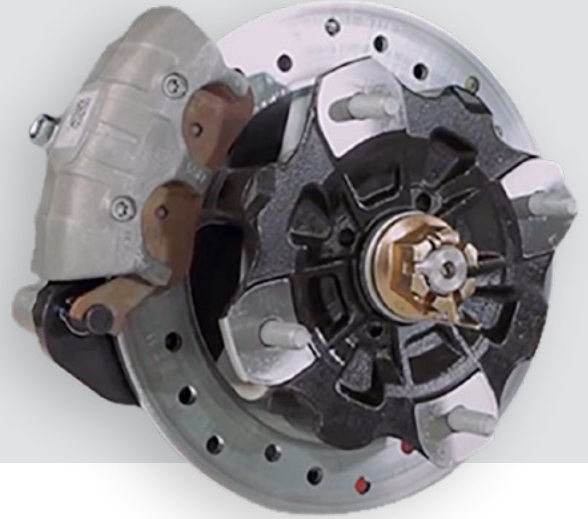

BRAKES

Metallic Brake Pad Kit

- Sintered compound delivers an optimal balance between durability, braking power, and noise.
- Each of our friction compounds is the result of joint research and development with industry leader Brembo.
- 1 SKU now includes left and right pads and all necessary hardware.



Models	Front	Rear Left	Rear Right	
Outlander 500/700 G3L, G3 850 (except X mr)		N/A	715900248	\$51.99
Outlander Pro G3L	705602167			\$105.99
Outlander G3 1000 & 850 X mr (except rear on G3 850)	705602167	705602167		\$105.99

Please contact your dealer or visit our online store at canamoffroad.com for suggested fitment.

DRIVE BELTS

Drive Belt

- High-performance design ideal for off-road use.
- BRP-specific calibration adjusted to best suit your Can-Am vehicle.



Models	CVT Drive Belt	
G3L (500 cc)	422280226	\$154.99
G3, G3L (700 cc and more)	422280225	\$154.99
G2, G2L, G2S (450 cc)	422280283	\$104.99
G2, G2L, G2S (500 cc and more)	422280366	\$179.99
DS70/90	V23100CJF020	\$105.99
DS250	S23100RB1000	\$158.99
Renegade 70/110	A2310018S000	\$105.99



Engineered to fit each Can-Am model, BRP drive belts are precisely calibrated to match clutch systems for maximum transfer, zero RPM loss, and unmatched throttle response. Field-tested and race-proven, they're built to take the heat. Literally.

DESIGNED TO PERFORM. PROVEN TO WIN.

From dyno to desert, BRP drive belts are tested in brutal real-world and race conditions.

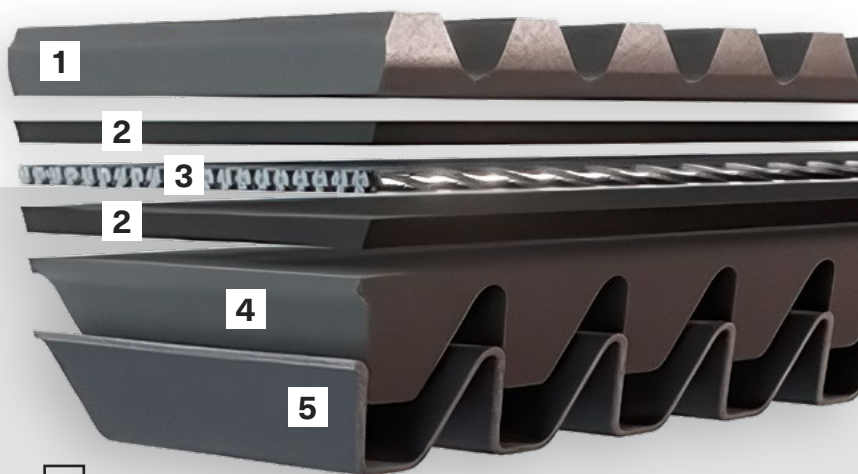

1

THE TOP COG

adds strength and limits deformation. It's made from a different compound than the lower cog to suit distinct power transfer roles.

2

ADHESION LAYERS

promote bonding between the cogged undercord compound and the aramid cord.

3

THE TENSILE CORD

is made with lightweight, high-strength aramid cords, each layer matched to your vehicle's specific power and performance demands.

4

THE UNDERCORD

is a custom mix of natural/synthetic rubbers and high-performance materials, designed for ideal flex and clutch engagement.

5

IMPREGNATED FABRIC

boosts wear resistance for both the belt and your clutches.



XPS

A TIRE FOR EVERY PURPOSE.



XPS TIRES

aren't just made to fit your vehicle, they're made to work perfectly with it.

DESIGN

Designed and engineered specifically for Can-Am, all tread patterns and tire aspects have been crafted to exact XPS specifications, giving you an exclusive tire designed to perform like no other.

TESTING

Every XPS tire goes through extreme testing—such as puncture, mileage, speed rating, and weight—to meet the same performance standards as your Can-Am vehicle.

COMPLETE LINEUP



The fast-growing lineup of XPS tires covers a vast range of the most popular sizes and specifications. ATV or SSV, 6- or 8-ply rating, radial or not, XPS has a purpose built tire for your playground.

XPS TIRES



SHOP BY USAGE





NEW XPS Recon Force

		<ul style="list-style-type: none"> • Utility inspired tire. • Shallow depth tread designed to handle hard pack terrain, increasing tread life. • Tight tread pattern to offer a smooth ride and minimal ground disturbance without compromising performance. • Designed for efficiency. • Tread depth: 15 mm - (0.6"). 	705403520 • 26X8R14	\$169.49
			705503616 • 26X10R14	\$190.99



NEW XPS Iron Force

	 	<ul style="list-style-type: none"> • 6-ply rated construction. • Multiple crown radius setup made to look square, reduce steering feedback, and enhance grip and tire cornering. • Tread depth: 16 mm - (0.6"). 	705403823 • 30X9R14	\$275.49
--	--	--	---------------------	----------



XPS Trail Force

		<ul style="list-style-type: none"> • All-terrain radial tire. • 6-ply rated construction. • Versatile and suitable for many types of terrain. • Aggressive tread pattern for better traction on dirt, mud and rocky terrains. • Tread depth: 20 mm (0.78"). 	705403026 • 26X8R14	\$169.49
			705503322 • 26X10R14	\$190.99



XPS TRAIL KING

	 	<ul style="list-style-type: none"> • All-terrain radial tire. • 6-ply rated construction. • Aggressive tread pattern for tougher terrains. • An almost continuous center tread offers a smoother trail ride. • Tread depth: 22 mm - (0.90"). 	705402713 • 26X8R12	\$179.99
			705503073 • 26X10R12	\$185.49
			705403464 • 27X8R14	N/A
			705503579 • 27X10R14	N/A
			705403730 • 28X8R14	\$179.99
705503813 • 28X10R14	\$185.49			



XPS TRAIL KING 2

	 	<ul style="list-style-type: none"> • All-terrain radial tire. • 6-ply rated construction. • Tire excels in various terrains from loose to hard packed. • Non-directional tread pattern with optimized construction providing precision handling and ensuring maximum grip and low rolling resistance. • Tread depth: 20 mm - (0.8"). 	705403398 • 26X8R14	\$169.49
			705503518 • 26X10R14	\$190.99
			705403397 • 27X8R14	\$201.49
			705503517 • 27X10R14	\$211.99

XPS SWAMP KING

		<ul style="list-style-type: none"> • Bias tires for mud and trail. • 6-ply rated construction. • Ultimate performance in mud without sacrificing good trail handling. • Tread depth: 38 mm (1.49"). 	705403674 • 28X8X14	N/A
			705503762 • 28X10X14	N/A

XPS SWAMP KING XL

		<ul style="list-style-type: none"> • Bias ply for mud and trail. • 6-ply rated construction. • Our best performing mud tire that does not compromise your trail riding. • Deep V grooved lugs with extended shoulder tread for max traction in deep ruts that also help eject mud faster. • Tread depth: 38 mm (1.49") center, max depth 52 mm (2.05"). 	705403381 • 30X9X14	\$328.49
			705503687 • 30X10X14	\$328.49



Powersport engines are some of the most powerful for their size. This reality creates a lot of pressure and stress on all components, including oils and lubricants. Finding the right balance between lubrication and durability is hard, but that's exactly what you'll find in every XPS bottle. Our chemistry evolved over thousands of testing hours to deliver power and durability like only XPS can.

XPS

OIL THAT GOES THE DISTANCE



XPS OILS

Developed as an integral part of the engine and vehicle, XPS lubricants don't settle for a certification. Always looking for more power and torque is in our DNA. This quest for performance created our need for specifically engineered lubricants.

LUBRICANT & OIL CHANGE KIT

LUBRICANT

XPS 4T 10W-50 Synthetic Oil



- Engineered for heavy-duty and high-performance 4-stroke engines, including turbocharged, supercharged and racing engines.
- Formulated using carefully selected and strenuously tested base stocks and custom additives.
- Offers thick film strength to protect bearings and a proven high-temp detergency to minimize deposits, prevent shear, provide thermal stability, and combat fuel dilution to ensure maximum performance from your engine.

9779234 • 1 qt / 946 ml
9779235 • 3.785 L

XPS 4T 0W-40 Synthetic Oil

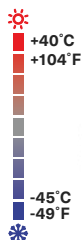

- Powersport formula with premium anti-wear and anti-corrosion additives.
- The best choice for high-performance snowmobile, ATV and SXS 4-stroke engines used in cold weather.
- Provides superior engine and transmission protection against heat, rust and corrosion.
- Delivers optimal performance in high and low temperatures.

9779139 • 1 qt / 946 ml
9779140 • 3.785 L

XPS 4T 5W-40 Synthetic Oil



- Off-road formula with premium anti-wear and anti-corrosion additives.
- Designed for high-performance off-road, on-road and PWC 4-stroke engines, including turbo or supercharged powersports engines.
- Provides superior engine and transmission protection against rust and corrosion, even in extreme conditions.

9779492 • 1 qt / 946 ml
9779493 • 3.785 L

OIL CHANGE KIT









Engine Oil Change Kit



Models	Product	
Rotax® 450 cc or Less Engine	4T 5W-40 Synthetic Oil Change Kit	9779487
Rotax® 450 cc or less Engine	4T 0W40 Synthetic Oil Change Kit	9779257
ACE 650 cc Single Cylinder Engine	4T 5W-40 Synthetic Oil Change Kit	9779480
ACE 650 cc Single Cylinder Engine	4T 0W-40 Synthetic Oil Change Kit	9779481
Rotax® 500 cc or More V-Twin Engine	4T 5W-40 Synthetic Oil Change Kit	9779488
Rotax® 500 cc or More V-Twin Engine	4T 0W-40 Synthetic Oil Change Kit	9779259
Rotax® 500 cc or More V-Twin Engine	4T 10W-50 Synthetic Oil Change Kit	9779252

- Ultra-convenient "all-in-one" Engine Oil Change Kit saves time and money.
- Includes XPS Synthetic Oil, Oil Filter, O-Rings and Washer.

MAINTENANCE PRODUCTS

Synthetic Gear Oil	75W-90 75W-140	9779158 • 1 qt / 946 ml 9779160 • 1 qt / 946 ml
	<ul style="list-style-type: none"> • Uses custom additives to provide the best performance in Visco-Lok™ and Smart-Lok™ differentials. • Allows higher loads, superior shear stability and reduced oxidation. • Exceptional wear protection and superior performance at all operating temperatures. 	
Extended Life Pre-Mixed Coolant	9779150 • 1 qt / 946 ml	
	<ul style="list-style-type: none"> • Antifreeze/coolant contains the correct dilution and the necessary additives to prevent corrosion and inhibit cavitation in BRP cooling systems. • Long-life, 5-year formula specially formulated for BRP vehicles. • Superior heat transfer. • Ideal replacement for vehicles that normally use a 2-year antifreeze/coolant (green). • 5 years (orange). 	
Anti-Corrosive Lubricant	9779701 • 14 oz / 400 g	
	<ul style="list-style-type: none"> • Multipurpose lubricant that can also be used to prevent rust, corrosion and moisture intrusion. • It contains extreme pressure additives that work as an all-around lubricant for just about anywhere lubrication is needed. 	
Extreme Duty Suspension Grease	9779708 • 14 oz / 400 g	
	<ul style="list-style-type: none"> • Designed to work specifically with the components found in Can-Am vehicle suspensions. • It is highly stable and offers optimal lubrication at both extreme cold and high temperatures while protecting suspension components from dirt and moisture, as well as corrosion under extreme washout conditions. 	
XPS Spine Grease	9779704 • 3 fl oz / 118 ml	
	<ul style="list-style-type: none"> • Formulated with molybdenum disulfide and synthetic graphite for maximum durability and long-lasting protection. • High performance formula that protects against wear, seizure, rust, corrosion, and extreme temperatures. • Ensures smooth assembly and disassembly, with consistent low-friction performance. 	
DOT 4 Brake Fluid	9779151 • 12 fl oz / 355 ml	
	<ul style="list-style-type: none"> • Meets or exceeds all DOT3 and DOT4 brake fluid requirements. • High-temperature formula resists fade and also conditions seals and O-rings in braking system. 	
Racing Brake Fluid RS600	9779152 • 12 fl oz / 355 ml	
	<ul style="list-style-type: none"> • Exceeds DOT4 brake fluid requirements for extreme conditions and competition use. • Extreme, 579-degree boiling point temperature is ideal for high-demand competition conditions to combat brake fade. • Will not harm seals or braking system components. • Should be added only to a clean/unfilled system to avoid dilution and diminished performance. • Low-moisture formula slows water vapor absorption through multiple heat cycles. • Recommended for use in Ski-Doo and Can-Am racing applications. 	
Fuel Stabilizer	9779171 • 8 fl oz / 236 ml	
	<ul style="list-style-type: none"> • Ethanol-compatible and will stabilize fuel in your tank to keep it from breaking down and causing hard starting, throttle hesitation and poor run quality. • Since ethanol attracts moisture, this product contains powerful anti-corrosion additives to protect fuel system components. • Prevents problems associated with E10 fuels. 	



XPS

**KEEP IT CLEAN.
KEEP IT RUNNING.**



XPS CARE

We know riding can get dirty real quick! To make sure riders spend more time riding and less time scrubbing, XPS Care offers a full lineup of products that make cleaning and detailing simple and efficient. Our proprietary solutions dissolve the dirt and grime, protect finishes, and even restore colors.

Level up your washing routine with XPS Care.

CARE PRODUCTS

Cleaner and Degreaser, All Purpose



- Ready-to-use formula.
- Cleans toughest dirt and grime.
- Phosphate free eco-friendly formula.
- Low-foam easy rinse formula.

9779328 • 22 fl oz / 650 ml
9779329 • 2 qt / 1.89 L

Matte Finish Waterless Cleaner



- Easy waterless use.
- Perfect for matte, flat and denim surfaces.
- Contains no wax or silicone.
- Leaves no unwanted streaks or marks.

9779330 • 22 fl oz / 650 ml

Multi-Surface and Glass Cleaner



- Easy waterless spray and wipe use.
- Polymer formula cleans and protects.
- Contains no wax or silicone.
- Leaves no unwanted streaks or marks.

9779331 • 22 fl oz / 650 ml

Mud and Dust Off-Road Wash



- Specially formulated for off-road vehicles, it breaks the bond holding grime and dirt to your vehicle's finish.
- The formula is biodegradable, eco-friendly with no phosphates or corrosive chemicals and is low foam for easy, quick rinsing.
- Effective on oil, grease and other stubborn grime.
- Safe for use on all surfaces.

9779340 • 33 fl oz / 946 ml
9779341 • 2 qt / 1.89 L

Black Plastic and Rubber Restorer



- Restores plastic, rubber and vinyl.
- Long-lasting formula.
- Protects against UV rays.

9779335 • 7.6 fl oz / 225 ml

Foaming Wash



- Concentrated formula for off-road vehicles, it produces a thick foam to lift dirt and prevent scratching.
- The pH neutral formula is safe for wax and paint sealants.
- Works in pressure washers or by hand.

9779337 • 16 fl oz / 473 ml
9779338 • 2 qt / 1.89 L

Quick Detailer Gloss Enhancing



- Quick detail spray wax.
- Leaves a high gloss finish at every wipe.
- Nanotechnology polymer formula.
- Repels dirt.
- No water needed.

9779332 • 4 fl oz / 118 ml
9779333 • 16 fl oz / 473 ml



CAN-AM APPAREL



CAN-AM APPAREL

Sizing chart	117
Communication systems	119
Helmets and goggles	121
Mud gear	125
Rainwear	125
Gloves	126
Can-Am x Fasthouse	128
Everyday wear	135
Signature collection	139
UV Protection and Play	144
Toys and Collectibles	145
Replacement parts	146

Always use the digital version
of the Products Spec Book for
the most updated information.



VIBE ON ANY HELMET

The Vibe Communication System delivers unparalleled connectivity and versatility when you ride. Fully compatible with most BRP helmets, this comm system might as well be an extension of the vehicle's ecosystem. This standout lets you chat, listen and ride all day long in comfort no matter how cold it is!



DID YOU KNOW ABOUT VIBE AND THE BRP GO! APP?
Ready, set, go! Set up and manage the Vibe Communication System in no time directly in the free BRP GO! mobile app. You can check the battery level, modify the audio settings and much more!

ONE CLICK TO CONNECT WITH OTHER MESH RIDERS	UNPARALLELED TALK TIME UP TO 12 HOURS (8 HOURS AT 0 °F)
SOUND BY HARMAN/KARDON®	OPEN MESH INTERCOM
UNIVERSAL FIT AND EASY TOOLLESS ASSEMBLY	FULL COMPATIBILITY WITH MOST HELMETS



OPEN MESH INTERCOM: LIMITLESS



MULTI-LANGUAGE VOICE COMMAND



GROUP MESH INTERCOM: UP TO 24 RIDERS



INTERCOM UP TO 2 KM / 1.2 MILES IN OPEN TERRAIN

COMMUNICATION SYSTEMS

MISC	Vibe Universal Comm System by BRP	929105 • One size	Matte Black (93)
		<ul style="list-style-type: none"> VIBE UNIVERSAL Comm System with superior audio quality for most BRP helmets. Sound by Harman Kardon®. Mesh-only system: Robust reliability compatible with all Sena Mesh devices. Battery capacity: up to 12 hours of talk time (8 hours at 0 °F). One-click-to-connect simplicity with other mesh riders. Mesh Intercom™ features superior audio quality. Up to 2 km/1.2 miles in open terrain. Range can be extended with multiple riders. Multi-channel protocol in open mesh allows users to switch between nine comm channels. 	<ul style="list-style-type: none"> Convenience of voice-activated digital assistant access ("OK Google"/"Hey Siri"). Rapid charging. Glove-friendly interface. Compatible with all BRP helmets. When paired with the BRP GO! app, you can manage many settings such as sound, mesh channel options, software updates, battery level, handlebar control and more. Wired and boom microphones included. 3-year limited warranty.

PYRA AND FLINT: BETTER THAN EVER!

The Can-Am Pyra helmets: where style meets performance. With the lightest helmet in our collection featuring high airflow and ERT protection, you'll be covered!

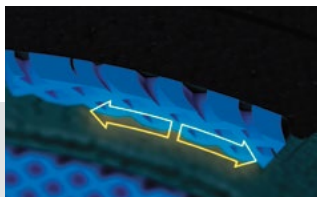

PROTECTION

Energy Reduction Technology (ERT) redirects force away from the head in the event of a fall.



LIGHTWEIGHT

Our lightest helmet starting at 1,240 g.



AIRFLOW

Don't sweat the ride with an open chin, removable wind deflector and rear vents.

- LIGHTWEIGHT
- ACCESSIBLE
- DOT/ECE

PERFECT FIT!

Experience unmatched comfort and fit with the Flint goggles and Pyra helmet—the ideal combination for your ride.



Can-Am Pyra Phantom Helmet
GREY
929159_09

Can-Am Pyra Phantom Helmet
BLACK
929159_90



Can-Am Flint Phantom UV Goggles
RED
286834_30



Can-Am Flint Phantom UV Goggles
SMOKE
286834_57

The Can-Am Flint goggles feature an injected PC lens that is anti-scratch and anti-fog and has distortion-free optics.

- ✓ UV protection
- ✓ Anti-fog
- ✓ Anti-scratch
- ✓ Frameless
- ✓ Designed to fit with the Pyra helmet

Second lens included



HELMETS AND GOGGLES

UNISEX

Can-Am Pyra Phantom Helmet

DOT ECE22.06

929159 • XS, S, M, L, XL, 2XL, 3XL

Black (90), Grey (09)



- 4-year limited warranty.
- Advanced plastic-composite shell with Energy Reduction Technology (ERT).
- Two-position adjustable peak.
- Front and rear hi-max air vent system to maximize cooling.
- Removable, washable and replaceable moisture-wicking liner.
- Lightweight double-D chin strap.
- Weight: starting at 1,240 grams.
- DOT/ECE 2206 certified.

Can-Am Pyra Fade Helmet

DOT ECE22.06

929078 • XS, S, M, L, XL, 2XL, 3XL

Beige (02), Turquoise (Aqua) (76), White (01)



- 4-year limited warranty.
- Advanced plastic-composite shell with Energy Reduction Technology (ERT).
- Two-position adjustable peak.
- Front and rear hi-max air vent system to maximize cooling.
- Removable, washable and replaceable moisture-wicking liner.
- Lightweight double-D chin strap.
- Weight: starting at 1,240 grams.
- DOT/ECE 2206 certified.

Can-Am Pyra Helmet

DOT ECE22.06

929038 • XS, S, M, L, XL, 2XL, 3XL

Charcoal Grey (07)



- 4-year limited warranty.
- Advanced plastic-composite shell with Energy Reduction Technology (ERT).
- Two-position adjustable peak.
- Front and rear hi-max air vent system to maximize cooling.
- Removable, washable and replaceable moisture-wicking liner.
- Lightweight double-D chin strap.
- Weight: starting at 1,240 grams.
- DOT/ECE 2206 certified.

Can-Am Flint Phantom UV Goggles

286834 • One size

Red (30), Smoke (57)



- The Can-Am Flint Phantom goggles feature an injected PC lens that is anti-scratch and anti-fog and has distortion-free optics.
- Thermo-formed 3-layer face foam offers best fit.
- No-slip silicone strap keeps goggles in place.
- Injection-molded PC cylindrical lens provides distortion-free vision and enhanced impact resistance.
- Tinted lens with anti-scratch and anti-fog performance with mirrored coating.
- Included extra clear lens for low-light conditions.
- Removable nose guard for extra deflection against debris.

Can-Am Flint Photochromic Goggles

448779 - One size

Charcoal Grey (07)



- Thermo-formed 3-layer face foam offers best fit.
- No-slip silicone strap keeps goggles in place.
- Injection-molded PC cylindrical lens provides distortion-free vision and enhanced impact resistance.

- Lens VLT from 80% to 28% with anti-scratch and anti-fog performance and with mirrored coating.
- Removable nose guard for extra deflection against debris.

Can-Am Trench UV Goggles

448696 - One size

Charcoal Grey (07), White (01)



- The Can-Am Trench goggle features injection PC lens that is anti-scratch and anti-fog and has distortion-free optics.
- Thermo-formed 3-layer face foam offers best fitting.
 - No-slip silicone strap keeps goggles in place.

- Injection-molded PC cylindrical lens provides distortion-free vision and enhanced impact resistance.
- Single lens with anti-scratch and anti-fog performance.
- Removable nose guard for extra deflection against debris.

Can-Am Trench OTG Goggles

448792 - One size

Matte Black (93)



- The Can-Am Trench OTG goggles feature an injected PC lens that is anti-scratch and anti-fog and has distortion-free optics.
- Thermo-formed 3-layer face foam offers best fit.
 - No-slip silicone strap keeps goggles in place.
 - Injection-molded PC cylindrical lens provides distortion-free vision and enhanced impact resistance.

- Single lens with anti-scratch and anti-fog performance.
- Removable nose guard for extra deflection against debris.
- Fits over most of the prescription glasses on the market with lens height below 2 in. (51 mm) and with arm width of 5 3/4 in. (146 mm).



FULL-FACE ACCESSIBILITY

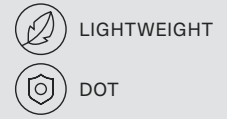

Open-Face Helmets

Designed for freedom and visibility. Offering a wide field of vision, allowing you to better enjoy the scenery and stay aware of your surroundings. You'll be sure to be comfortable with these stylish and ultra-light helmets.



BLACK WITH GRAPHICS
929150_94

MATTE BLACK
929140_93

LIGHTWEIGHT

Advanced light-plastic composite shell. Enjoyable for short or longer rides.

OPEN-FACE HELMET

Perfect for full-face accessibility.

COMFORT

Ultra-comfortable and washable linings.

UNISEX	NEW Can-Am Retro Open Face Helmet	DOT	929150 • S, M, L, XL, 2XL	Black with Graphics (94), Matte Black (93)
			<ul style="list-style-type: none"> Advanced thermoplastic shell. Multi-density EPS. 2 shell sizes and 3 EPS sizes for better fit and comfort. Removable peak. Ultra-comfort, removeable and hand-washable linings. 	<ul style="list-style-type: none"> Quick-release chin strap. Eyewear compatible. Communication system-ready. Fit: Medium Oval. DOT-certified. <p>Weight:</p> <ul style="list-style-type: none"> - XS-L: 1,140 g ± 50 g. - XL-XXL: 1,200 g ± 50 g.
	Can-Am Exome Helmet	DOT ECE2206	929040 • XS, S, M, L, XL, 2XL, 3XL	Sand (03), Charcoal Grey (07)
			<ul style="list-style-type: none"> Perfect for adventure riding, on or off the trails. Modular helmet with advanced plastic-composite shell. Pinlock-ready multi-position and anti-scratch visor. Interchangeable retractable sun visor. Removable aerodynamic peak. Ultra-comfortable washable linings. Adjustable air vents and exhausts. DOT/ECE 2206 certified. 	
	Can-Am Exome Open-Face Helmet	DOT	929140 • XS, S, M, L, XL, 2XL, 3XL	Grey (09), Matte Black (93)
			<ul style="list-style-type: none"> Perfect for adventure riding, on or off the trails in summer conditions. Advanced plastic composite shell. Anti-scratch amber visor. Interchangeable retractable sun visor. Fixed aerodynamic peak. Ultra-comfortable washable linings. Adjustable air vents and exhausts. DOT-certified. 	

HELMETS

MEN'S & WOMEN'S

	2XS	XS	S	M	L	XL	2XL	3XL
Sizing Code	01	02	04	06	09	12	14	16
Head (inches)	20 7/8-21 1/4	21 5/8-22	22 3/8-22 3/4	23 1/8-23 5/8	24-24 3/8	24 3/4-25 1/8	24 3/4-25 1/8	25 1/2-25 7/8
Head (cm)	53-54	55-56	57-58	59-60	61-62	63-64	63-64	65-66

PHANTOM

Introducing the beloved Phantom collection

Built for riders who demand more. Featuring a 100% waterproof jacket and pants, but also protective gear such as helmet and goggles. All of them showcasing the striking phantom graphic. Full protection. Maximum style.



Can-Am Pyra
Phantom Helmet
BLACK
929159_90



Can-Am Flint
Phantom UV
Goggles
SMOKE
286834_57



Unisex Can-Am
Waterproof
Mud Jacket
CAMO
456046_37



Unisex Can-Am
Waterproof
Mud Pants
BLACK
456067_90

Unisex Can-Am
Waterproof
Mud Jacket
BLACK
456046_90



MUD GEAR

UNISEX

Can-Am Waterproof Mud Jacket

456046 • S, M, L, XL, 2XL

Black (90), Camo (37)



- Mud jacket made of waterproof PVC.
- 98.5% polyvinyl chloride (PVC), 1.5% mesh polyester.
 - Electronically welded seams.
 - Back panel ventilation (with mesh).
 - Elastic cuffs, hem and hood.
 - Can-Am logo.

Can-Am Waterproof Mud Pants

456067 • S, M, L, XL, 2XL

Black (90), Camo (37)



- Oversized pants made of 100% waterproof PVC.
- 100% polyvinyl chloride (PVC).
 - Electronically welded seams.
 - Elastic waistband and ankle cuff.
 - Can-Am logo.

RAINWEAR

UNISEX

NEW Unisex Can-Am Seil Lite WP Jacket

456072 • S, M, L, XL, 2XL, 3XL

Hi-Vis Yellow (26)



- Simple yet carefully designed and beautifully made lightweight weather protection unisex jacket. 100% waterproof. Intelligent sizing – To be fit over your normal riding gear, sized accordingly.
- Main material: 100% laminated polyester.
 - Fit: Relax.
 - Waterproof/breathable: 10K/3K, 2.5-layer membrane.
 - Hi-vis material at sleeves.
 - Fully seam-sealed.
 - Double storm placket front closure with one-way zipper.
 - Stowable adjustable hood (inside collar).
 - Reflective details and logo.
 - Elasticized cuff with silicone grip inside.
 - Back panel ventilation.
 - Adjustable hem.
 - Lightweight.
 - Unisex sizing to fit over clothes.
 - One size down for women.

NEW Unisex Can-Am Seil Lite WP Overpants

442457 • XS, S, M, L, XL, 2XL, 3XL

Black (90)



- Simple yet carefully designed and beautifully made lightweight weather protection unisex overpants. 100% waterproof. Intelligent sizing – To be fit over your normal riding gear, sized accordingly.
- Main material: 100% laminated polyester.
 - Fit: Relax.
 - Waterproof: 10K/3K, 2.5-layer membrane.
 - Elastic waistband with silicone grip all around.
 - Silicone grip at bottom hem.
 - Fully seam-sealed.
 - Reflective logo.
 - Hem opening with zipper.
 - Stretch boot straps.
 - Lightweight.
 - Unisex sizing to fit over clothes.
 - One size down for women.

GLOVES

MEN'S

NEW Can-Am Rally Gloves

286836 · S, M, L, XL, 2XL, 3XL

Black (90)



Our new Can-Am Rally Gloves are highly breathable for hot riding conditions.

Mesh on the upper and light perforated microsuede on the inside of the palm for a perfect grip and air flow.

- 92% polyester, 8% spandex.

- Ventilated air mesh upper construction.

- Reinforcement thumb panel for extra durability.

- Single-layer microsuede palm with minimal padding.

- Stretch finger gussets.

- Embossed and expandable neoprene slip-on cuff.

- Touchscreen function.

GLOVES (measure palm width)

UNISEX

	XS	S	M	L	XL	2XL	3XL
Sizing Code	02	04	06	09	12	14	16
Palm (inches)	3	3¼	3½	4	4½	5	5½
Palm (cm)	7.5	8	9.5	10	11.5	13	14



CAN-AM x FASTHOUSE

Desert racing runs deep in Fasthouse's roots. Their passion is forged by the camaraderie, good times and heritage of Fasthouse is built upon the legacy of those who came before it, while forging its own path by being the Purveyors of Good Times®. This collection merges Fasthouse's aesthetic with Can-Am Off-Road's prowess, a partnership that sets a new benchmark for off-road lifestyle, capturing the core of their shared values and leaving behind a legacy for all to revel in.



Men's Can-Am x FH
Ride Out T-Shirt
BLACK
288225_90



Men's Can-Am x FH
Adventure Long
Sleeve T-Shirt
WHITE
288226_01
BLACK
288226_90

Unisex
Can-Am x FH
Dust Gloves
BLACK
446389_90



Men's Can-Am x FH
Mav T-Shirt
SAND
288218_03
BLACK
288218_90



Women's Can-Am x FH
Adventure T-Shirt
BLACK
288228_90



CAN-AM x FASTHOUSE

MEN'S

NEW Unisex CAN-AM x FH Dust Gloves

446389 • XS, S, M, L, XL, 2XL

Black (90)



The Dust gloves utilize quality materials with a traditional moto fit.

- 77% polyamide, 15% polyurethane, 7% elastane, 1% polychloroprene.
- Durable form-fitting 2-way stretch material.
- Perforated Clarino® palm and thumb guards.

- Touchscreen fingertips on index and thumb.
- Gusseted knuckles for increased dexterity.
- Molded neoprene low-pro cuff.
- Mesh finger gussets and silicone grippers.
- TPR and printed embellishments throughout.

NEW Can-Am x FH Dust Pants

288018 • 28, 30, 32, 34, 36, 38, 40, 42

Black (90)



The Dust pants are designed for those who venture off the beaten path. They feature a classic fit with cargo-style pockets, full-grain leather inner knee panels, and 600D poly main panel construction, all engineered to endure the harshest conditions and enhance your performance for the adventure ahead.

- 69% polyester, 27% nylon, 4% spandex.
- Fit: Fitted.
- Zippered cargo pockets.

- Zippered mesh ventilation pockets on both thighs.
- Zippered fly for easy pit stops.
- 600-denier poly and 4-way stretch main body fabric.
- High-strength nylon thread, double- and triple-stitched seams.
- Silky soft tricot, ¾-length knee brace, optimized lining.
- Patterned and fit for every style of rider.

Please refer to the sizing chart below:

Size	Code	Size	Code	Size	Code	Size	Code
28	36	32	38	36	40	40	42
30	37	34	39	38	41	42	43

NEW Can-Am x FH Mav Pullover Hoodie

288227 • S, M, L, XL, 2XL, 3XL

Gold (11)



Midweight hooded pullover for men.

- 80% cotton, 20% polyester.
- Soft midweight material (280 gsm).
- Fit: Regular.
- Two front welt pockets.
- Metal eyelets and hood drawstring.
- Screen printed graphics.
- Ribbed sleeve cuffs and waistband hem.

NEW Can-Am x FH Triad T-Shirt

288236 • S, M, L, XL, 2XL, 3XL

Black (90), Heather Charcoal (29)



Can-Am x Fasthouse Collab T-Shirt with brand logos and graphics.

- 60% cotton, 40% polyester.
- Fit: Slim.
- Ribbed collar.

Can-Am x FH Motorall

441716 • 28, 30, 32, 34, 36, 38, 40, 42

Black (90)









The Motorall® is our tried and true Grindhouse moto pant in an overalls cut.

- 69% polyester, 27% nylon, 4% spandex.
- Fit: Fitted.
- Zippered cargo pockets on front chest and both thighs.
- Zippered mesh ventilation pockets on both thighs.
- Zippered fly for easy pit stops.
- Adjustable elastic comfort straps for step-in entry.

- 600-denier poly and 4-way stretch main body fabric.
- Upper chest molle straps for radios, tools and accessories.
- High-strength nylon thread double- and triple-stitched seams.
- Silky soft tricot, ¾-length knee brace, optimized lining.
- Patterned and fit for every style of rider.

Please refer to the sizing chart below:

Size	Code	Size	Code	Size	Code	Size	Code
28	36	32	38	36	40	40	42
30	37	34	39	38	41	42	43

<p>NEW Can-Am x FH Dust Jersey</p>	<p>288234 • S, M, L, XL, 2XL, 3XL</p>	<p>Army Green (77), Black (90)</p>	
	<p>High-performance jersey utilizing breathable materials with a traditional cut.</p> <ul style="list-style-type: none"> • 100% polyester. • Fit: Regular. • High-quality silk-screened graphics. • Moisture-wicking materials help keep you dry. • Mesh vent paneling on sides and under sleeves for airflow. • Drop tail on back panel to keep jersey tucked in and secure. • Athletic fit, moderately slim throughout body and sleeves. • Overlocked stitching for superior durability and longevity. 		
<p>NEW Can-Am x FH High Country T-Shirt</p>	<p>288235 • S, M, L, XL, 2XL, 3XL</p>	<p>Bronze (92)</p>	
	<p>Can-Am x Fasthouse Collab T-Shirt with large soft plastisol print at back and small print at front chest.</p> <ul style="list-style-type: none"> • 60% cotton, 40% polyester. • Fit: Slim. • Rib-knit crew neck. • Woven label Can-Am x Fasthouse on wearer's right sleeve. 		
<p>Can-Am x FH Mav T-Shirt</p>	<p>288218 • S, M, L, XL, 2XL, 3XL</p>	<p>Black (90), Sand (03)</p>	
	<p>Can-Am x Fasthouse collab T-shirt with large artistic vehicle print at back.</p> <ul style="list-style-type: none"> • 60% cotton, 40% polyester. • Fit: Slim. • Ribbed collar. • Quote at left chest and large artwork at back. 		
<p>Can-Am x FH Off-Road Crew T-Shirt</p>	<p>288224 • S, M, L, XL, 2XL, 3XL</p>	<p>Army Green (77), Black (90)</p>	
	<p>Can-Am x Fasthouse collab T-shirt with large Off-Road graphic at back.</p> <ul style="list-style-type: none"> • 60% cotton, 40% polyester. • Fit: Slim. • Ribbed collar. • Quote at left chest and back. 		
<p>Can-Am x FH Ride Out T-Shirt</p>	<p>288225 • S, M, L, XL, 2XL, 3XL</p>	<p>Black (90), White (01)</p>	
	<p>Can-Am x Fasthouse collab T-shirt with artistic landscape printed at back.</p> <ul style="list-style-type: none"> • 60% cotton, 40% polyester. • Fit: Slim. • Ribbed collar. • Brand logo at center front and large artwork at back. 		
<p>Can-Am x FH Adventure Long-Sleeve T-Shirt</p>	<p>288226 • S, M, L, XL, 2XL, 3XL</p>	<p>Black (90), White (01)</p>	
	<p>Can-Am x Fasthouse collab long-sleeve T-shirt with brand logos and emblematic Can-Am lines.</p> <ul style="list-style-type: none"> • 60% cotton, 40% polyester. • Fit: Slim. • Ribbed collar. • Brand logos at center front and back. 		

MEN'S

Can-Am x FH Coilover Tee**288065** • S, M, L, XL, 2XL, 3XL | Black (90)

- Ultrasoft 100% combed ring-spun cotton tee.
- 100% combed ring-spun cotton.
 - Fit: Slim.
 - Soft and lightweight material.
 - Crew collar.
 - Plastisol ink screen-printed graphics.

WOMEN'S

NEW Can-Am x FH Off-Road Crew Pullover Hoodie**288229** • S, M, L, XL, 2XL | Ivory (97)

- Midweight hooded pullover for women.
- 80% cotton, 20% polyester.
 - Fit: Regular.
 - Soft midweight material (280 gsm).
 - Two front welt pockets.
 - Metal eyelets and hood drawstring.
 - Screen printed graphics.
 - Ribbed sleeve cuffs and waistband hem.

Can-Am x FH Adventure T-Shirt**288228** • XS, S, M, L, XL, 2XL | Black (90), Sand (03)

- Can-Am x Fasthouse collab women's T-shirt with brand logos and emblematic Can-Am lines.
- 60% cotton, 40% polyester.
 - Fit: Slim.
 - Ribbed collar.
 - Brand logos at center front and back.

UNISEX

NEW Can-Am x FH Adventure Beanie**288231** • One size | Army Green (77), Black (90)

- Can-Am x Fasthouse collab heavy-knit cuff beanie.
- 100% acrylic.
 - Ultrasoft anti-itch material.
 - Can-Am x Fasthouse woven patch at front.
 - Small folded Can-Am x Fasthouse label at back.

NEW Can-Am x FH Straw Hat**448814** • One size | Khaki (05)

- Wide-brim straw hat with adjustable chin strap.
- 100% straw.
 - Patch at front.
 - One size fits most.

NEW Can-Am x FH Tube**288232** • One size | Black (90), Wine (32)

- Multipurpose, stretch and comfortable tubular headwear.
- 92% polyester, 8% spandex.
 - 12 different configurations: bandana, headband, balaclava and more.

Can-Am x FH Dust Mesh Cap**288238** • One size

Black (90), Whiskey (28)



Check out the Can-Am x FH Dust cap, a medium-profile structured 5-panel snapback constructed using a premium cotton/poly blend. Features a front patch and custom trims throughout.

- 60% cotton, 40% polyester.
- 5-panel construction.
- Deep profile, structured.
- Woven front patch.
- Contrast snapback closure.

Can-Am x FH Road Cap**288230** • One size

Black (90)



Can-Am x Fasthouse collab structured 5-panel trucker-style cap with snapback closure.

- 100% cotton.
- 5-panel construction.
- Curved brim.
- Woven patch at front.
- Branded taping and flag label.
- Snapback closure at back.

Can-Am x FH Racing Flat Brim Cap**448804** • One size

Black (90), Brown (04)



Structured 5-panel snapback with flat brim using premium acrylic wool.

- 100% cotton.
- 5-panel construction.
- Flat brim and matching underbrim.
- Branded taping and flag label.
- Contrast snapback.
- Snapback closure at back.

Can-Am x FH Badge Cap**448805** • One size

Army Green (77), Ivory (97)



Structured 5-panel trucker-style cap with snapback closure.

- 100% cotton.
- 5-panel construction.
- Curved brim.
- Woven patch at front.
- Branded taping and flag label.
- Snapback closure at back.

CAN-AM OFF-ROAD x 24.7

**Hunt limited-edition hat capsule.
Built for the hunt, backed by the ride.**

Where grit meets gear: Can-Am Off-Road and 24.7 Hunt unveil an exclusive hat collection designed for those who live the outdoors without compromise. As a top Can-Am Off-Road Ambassador since 2024, 24.7 Hunt has earned a reputation as one of the most respected names in the hunting and conservation community, bringing proven insight, a relentless pursuit of the passion, and a deep respect for the land and its animals into everything they do.

This collaboration isn't just about style—it's about being unstoppable. These hats are made for the early risers and late nighters who do it all in their own pursuits.



Unisex Can-Am
x 24.7 Curved Cap
288482_90



Unisex Can-Am
x 24.7 Red/Black
Flat Cap
288483_30



Unisex Can-Am
x 24.7 Green
Rope Cap
288484_77



Unisex Can-Am
x 24.7 Black
Mesh Flat Cap
288485_90



24.7 x CAN-AM COLLECTION

UNISEX

Can-Am x 24.7 Curved Cap

288482 • One size

Black (90)



- Can-Am x 24.7 Hunt Collaboration.
- Content: 100% cotton corduroy.
 - 5-panel construction.
 - Curved brim.
 - Embroidered woven patch at front.
 - Embroidered brands on both sides of the cap.
 - Branded an-Am taping inside.
 - Snapback closure at back.

Can-Am x 24.7 Red/Black Flat cap

288483 • One size

Red (30)



- Can-Am x 24.7 Hunt Collaboration.
- Content: 100% cotton corduroy.
 - 5-panel construction.
 - Flat brim.
 - Half structured front.
 - Rope.
 - Embroidered woven patch at front.
 - Embroidered brands on both sides of the cap.
 - Branded Can-Am taping inside.
 - Snapback closure at back.

Can-Am x 24.7 Green Rope Cap

288484 • One size

Army Green (77)



- Can-Am x 24.7 Hunt Collaboration.
- Content: 100% cotton.
 - 5-panel construction.
 - Flat brim.
 - Rope.
 - Embroidered Duck patch in Can-Am color at front.
 - Embroidered brands on both sides of the cap.
 - Branded an-Am taping inside.
 - Snapback closure at back.

Can-Am x 24.7 Black Mesh Flat Cap

288485 • One size

Black (90)



- Can-Am x 24.7 Hunt Collaboration.
- Content: 100% cotton.
 - 5-panel construction.
 - Flat brim.
 - Structured front.
 - Mesh back.
 - Embroidered woven patch at front.
 - Embroidered brands on both sides of the cap.
 - Snapback closure at back.

EVERYDAY WEAR AND SIGNATURE

Our redesigned everyday and Signature collections.

Perfect for those who crave adventure and want to get the job done. Featuring a fresh selection of stylish and practical pieces such as flannel shirts, caps, T-shirts and more!



Men's Can-Am
DNA T-Shirt
ARMY GREEN
288173_77



Unisex Can-Am
Loyal Flat Mesh Cap
BLACK
288143_90



Unisex Can-Am
Laser Cut Curved Cap
SAND
288144_03



Unisex Can-Am
Reversible Camo
Beanie
GREY
288160_09







Men's Can-Am
Emblem Pullover
Hoodie
BLACK
288244_90



Men's Can-Am
Plaid Flannel Shirt
SAND
288165_03

EVERYDAY WEAR

MEN'S

<p>NEW Can-Am All-Star T-Shirt</p> 	<p>288181 • S, M, L, XL, 2XL, 3XL</p>	<p>Army Green (77), Black (90), Wine (32)</p>
<p>Casual T-shirt for everyday wear.</p> <ul style="list-style-type: none"> • 60% cotton, 40% polyester. • Fit: Slim. • Rib-knit crew neck. 		
<p>NEW Can-Am All Terrain T-Shirt</p> 	<p>288184 • S, M, L, XL, 2XL, 3XL</p>	<p>Black (90), Heather Grey (27)</p>
<p>Men's Casual Graphic T-Shirt with Can-Am Crest artwork.</p> <ul style="list-style-type: none"> • Solid: 60% cotton, 40% polyester. • Heather: 97% cotton, 3% polyester. • Fit: Regular. • Rib-knit crew neck. • Small artwork at left chest and artwork at back. 		
<p>NEW Can-Am Heritage T-Shirt</p> 	<p>288275 • S, M, L, XL, 2XL, 3XL</p>	<p>Black (90), Heather Grey (27)</p>
<p>Men's Casual Graphic T-Shirt with Heritage artwork at back.</p> <ul style="list-style-type: none"> • Solid: 60% cotton, 40% polyester. • Heather: 97% cotton, 3% polyester. • Fit: Regular. • Ribbed collar. • Small Can-Am logo at left chest and artwork at back. • Small embroidered label at front. 		
<p>NEW Can-Am '73 T-Shirt</p> 	<p>288276 • S, M, L, XL, 2XL, 3XL</p>	<p>Black (90)</p>
<p>Men's Casual Graphic T-Shirt with large '73 Can-Am logo at front.</p> <ul style="list-style-type: none"> • 60% cotton, 40% polyester. • Fit: Regular. • Ribbed collar. • Small embroidered label at front. 		
<p>NEW Can-Am Legacy T-Shirt</p> 	<p>288279 • S, M, L, XL, 2XL, 3XL</p>	<p>Heather Charcoal (29), White (01)</p>
<p>Men's Casual Graphic T-Shirt with retro Can-Am logo at front.</p> <ul style="list-style-type: none"> • 60% cotton, 40% polyester. • Fit: Regular. • Ribbed collar. • Small embroidered label at front. 		

Can-Am Plaid Flannel Shirt**288165** • S, M, L, XL, 2XL, 3XL

Sand (03)



Comfortable plaid flannel shirt, perfect for all your adventures!

- 100% cotton.
- Fit: Regular.
- Front opening with debossed Can-Am 4-hole buttons.

- Left chest pocket with small Can-Am embroidery.
- Contrast woven back yoke, chest pocket and elbow patches for more durability.

Can-Am Bonded Plaid Overshirt**288163** • S, M, L, XL, 2XL, 3XL

Army Green (77)



Bonded micro-fleece plaid overshirt, perfect for colder days.

- 100% cotton, fleece, 100% polyester.
- Fit: Relaxed.
- Front opening with debossed Can-Am 4-hole buttons.
- Herringbone weave bonded to soft micro polar fleece.
- Back yoke and chest pocket fabric cut on bias for stretch.

- Two hand pockets and two chest pockets.
- Small Can-Am embroidered logo at front left pocket.
- Self hanger loop centered at back yoke.

Cobra Desert Pullover Hoodie**288155** • S, M, L, XL, 2XL, 3XL

Black (90), Heather Grey (27)



Casual pullover hoodie with desert-inspired artwork at back.

- 60% cotton, 40% polyester.
- Fit: Regular.

- Rib at cuffs and hem.
- Kangaroo pocket.
- Soft plastisol print graphic at back. Regular Can-Am logo at left chest.

Cobra Desert T-Shirt**288151** • S, M, L, XL, 2XL, 3XL

Black (90), Sand (03)



Men's casual graphic T-shirt with desert-inspired artwork at back.

- 60% cotton, 40% polyester.
- Fit: Regular.

- Ribbed collar.
- Small Can-Am logo at left chest and artwork at back.

Can-Am Loyal T-Shirt**288152** • S, M, L, XL, 2XL, 3XL

Black (90), Heather Grey (27)



Men's casual graphic T-shirt with Can-Am printed quote at back.

- 60% cotton, 40% polyester.
- Heather Grey (27): 97% cotton, 3% polyester.
- Fit: Regular.

- Ribbed collar.
- Small Can-Am logo at left chest and artwork at back.

Can-Am Fearless Ally T-Shirt

288153 • S, M, L, XL, 2XL, 3XL

Army Green (77), Black (90)



Men's casual graphic T-shirt with large cobra artwork at front.
 • 60% cotton, 40% polyester.
 • Fit: Regular.

- Ribbed collar.
- Large cobra artwork at front with Can-Am mention.

Can-Am DNA T-Shirt

288173 • S, M, L, XL, 2XL, 3XL

Army Green (77), Black (90)



Men's Can-Am graphic T-shirt, perfect for everyday wear.
 • 60% cotton, 40% polyester.
 • Fit: Regular.

- Ribbed collar.
- Large Can-Am graphic at front.

Can-Am Bones T-Shirt

288182 • S, M, L, XL, 2XL, 3XL

Black (90), Heather Grey (27)



Men's casual graphic T-shirt with skeletal vehicle artwork printed at back.
 • 60% cotton, 40% polyester.
 • Heather Grey (27): 97% cotton, 3% polyester.
 • Fit: Regular.

- Ribbed collar.
- Small Can-Am logo at left chest and large artwork at back.

Can-Am Badges Long Sleeve T-Shirt

288166 • S, M, L, XL, 2XL, 3XL

Black (90)



Men's long-sleeve T-shirt with printed Can-Am badges.
 • 60% cotton, 40% polyester.
 • Fit: Regular.

- Ribbed collar.
- Printed Can-Am badges on the sleeve and left chest.

NEW Can-Am All-Star T-Shirt

288149 • XS, S, M, L, XL, 2XL

Black (90), Wine (32)



Women's Casual Graphic T-Shirt.
 • Solid color: 60% cotton, 40% polyester.
 • Heather color: 97% cotton, 3% polyester.
 • Fit: Slim.
 • Rib-knit crew neck.

NEW Can-Am Heritage T-Shirt

288285 • XS, S, M, L, XL, 2XL

Black (90), Pink (36)



Women's Casual Graphic T-Shirt with Heritage artwork at back.
 • Content: 60% cotton, 40% polyester.
 • Fit: Slim.
 • Ribbed collar.
 • Small Can-Am logo at left chest and artwork at back.
 • Small embroidered label at front.

NEW Can-Am '73 T-Shirt

288286 • XS, S, M, L, XL, 2XL

Black (90)



Women's Casual Graphic T-Shirt with large 73 Can-Am logo at front.

- Content: 60% cotton, 40% polyester.
- Fit: Slim.
- Ribbed collar.
- Small embroidered label at front.

Can-Am Loyal T-Shirt

288150 • XS, S, M, L, XL, 2XL

Black (90), White (01)



Women's casual graphic T-shirt with Can-Am printed quote at back.

- 60% cotton, 40% polyester.
- Fit: Slim.

- Ribbed collar.
- Small Can-Am logo at left chest and artwork at back.

NEW Can-Am Mav Bones Flat Cap

288176 • One size

Army Green (77)



Unisex Mav Bones Cap with flat brim.

- 100% cotton.
- Structured 6-panel cap.
- Snapback closure at back.
- Inside Can-Am branded tape.
- Patch at front.

NEW Can-Am King Cobra Curved Cap

288177 • One size

Black (90), Sand (03)



Unisex King Cobra curved-brim cap.

- 100% cotton.
- 6-panel cap.
- Soft plastisol printed patch.
- Can-Am branded tape inside and flag label at back.
- Snapback closure at back.

NEW Can-Am Heritage Curved Cap

288264 • One size

Black (90)



Classic Curved Cap with a Can-Am patch at front.

- 100% cotton.
- 6-panel cap.
- Heritage patch embroidered at front.
- Can-Am branded tape inside.
- Snapback closure at back.

Can-Am Laser Cut Curved Cap

288144 • One size

Black (90), Sand (03)



Unisex breathable cap with laser-cut mesh.

- 100% polyester.
- UPF 30 sun protection.
- Quick-dry.
- Silicon patch at front.
- Snapback closure at back.

UNISEX

Can-Am Loyal Flat Mesh Cap**288143** • One size

Army Green (77), Black (90)



Unisex mesh cap with flat brim.

- Content: 100% cotton.
- Mesh: 100% polyester.
- Structured 5-panel cap.
- Snapback closure at back.
- Patch at center front.
- Small Can-Am label at back.

SIGNATURE COLLECTION

MEN'S

NEW 1973 Signature T-Shirt**288278** • S, M, L, XL, 2XL, 3XL

Black (90), Red (30), White (01)



Men's Casual Signature T-Shirt with Can-Am logo and 1973.

- 60% cotton, 40% polyester.
- Fit: Regular.
- Rib at cuffs and hem.
- Can-Am logo at center front and small 1973 printed on the right sleeve.
- Small embroidered label at front.

1973 Signature LS T-Shirt**288355** • S, M, L, XL, 2XL, 3XL

Black (90)



Men's Casual Signature Long-Sleeve T-Shirt with Can-Am logo and 1973.

- 60% cotton, 40% polyester.
- Fit: Regular.
- Rib at cuffs and hem.
- Can-Am logo at center front and small 1973 printed on the right sleeve.
- Small embroidered label at front.

Can-Am Emblem T-Shirt**288148** • S, M, L, XL, 2XL, 3XL

Black (90), Heather Grey (27), Sand (03)



Men's Signature T-shirt with Can-Am logo and emblematic lines at front.

- 60% cotton, 40% polyester.
- Heather Grey (27): 97% cotton, 3% polyester.
- Fit: Regular.
- Ribbed collar.

NEW 1973 Signature Crewneck Sweatshirt**288353** • S, M, L, XL, 2XL, 3XL

Black (90)



Men's Signature Crewneck Sweatshirt with Can-Am logo and 1973.

- 60% cotton, 40% polyester.
- Fit: Regular.
- Rib at cuffs and hem.
- Can-Am logo at center front and small 1973 printed at back neck.
- Small embroidered label at front.

Can-Am Emblem Crewneck**288241** · S, M, L, XL, 2XL, 3XL

Black (90), Heather Grey (27)



Men's Signature crewneck sweatshirt with Can-Am logo and emblematic lines at front.

- 60% cotton, 40% polyester.
- Fit: Regular.
- Rib at cuffs and hem.

NEW 1973 Signature Pullover Hoodie**288354** · S, M, L, XL, 2XL, 3XL

Black (90), Heather Grey (27)



Men's Signature Pullover Hoodie with Can-Am logo and 1973.

- 60% cotton, 40% polyester.
- Fit: Regular.
- Rib at cuffs and hem.
- Kangaroo pocket.
- Can-Am logo at center front and 1973 printed across the center panel of the hood.
- Small embroidered label on the kangaroo pocket.

Can-Am Emblem Pullover Hoodie**288242** · S, M, L, XL, 2XL, 3XL

Black (90), Sand (03)



Men's Signature pullover hoodie with Can-Am logo and emblematic lines at front.

- 60% cotton, 40% polyester.
- Fit: Regular.
- Rib at cuffs and hem.
- Kangaroo pocket.

Can-Am Emblem Cap**288142** · One size

Army Green (77), Black (90), Burgundy (35), Heather Grey (27)



Signature cap with Can-Am logo and emblematic lines at front.

- 100% cotton.
- 6-panel cap.
- Embroidered Can-Am logo on the front.

- Can-Am branded tape inside and flag label at back.
- Snapback closure at back.

NEW 1973 Signature T-Shirt

288284 • XS, S, M, L, XL, 2XL

Black (90), Pink (36)



- Women's Casual Signature T-Shirt with Can-Am logo and 1973.
- Content: 60% cotton, 40% polyester.
 - Fit: Slim.
 - Rib at cuffs and hem.
 - Can-Am logo at center front and small 1973 printed on the right sleeve.
 - Small embroidered label at front.

Can-Am Emblem T-Shirt

288187 • XS, S, M, L, XL, 2XL

Black (90), Sand (03)



- Women's Signature T-shirt with Can-Am logo and emblematic lines at front.
- 60% cotton, 40% polyester.
 - Fit: Slim.
 - Ribbed collar.

NEW 1973 Signature Crewneck Sweatshirt

288352 • XS, S, M, L, XL

Black (90)



- Women's Signature Crewneck Sweatshirt with Can-Am logo and 1973.
- Content: 60% cotton, 40% polyester.
 - Fit: Slim.
 - Rib at cuffs and hem.
 - Can-Am logo at center front and small 1973 printed at back neck.
 - Small embroidered label at front.

Can-Am Emblem Crewneck

288243 • XS, S, M, L, XL, 2XL

Black (90), Wine (32)



- Women's Signature crewneck sweatshirt with Can-Am logo and emblematic lines at front.
- 60% cotton, 40% polyester.
 - Fit: Slim.
 - Rib at cuffs and hem.

NEW 1973 Signature Pullover Hoodie

288351 • XS, S, M, L, XL

Black (90), Wine (32)



- Comfortable Pullover Hoodie sweatshirt with Can-Am logo on the front.
- Content: 60% cotton, 40% polyester.
 - Fit: Slim.
 - Rib at cuffs and hem.
 - Kangaroo pocket.
 - Can-Am logo at center front and 1973 printed across the center panel of the hood.
 - Small embroidered label on the kangaroo pocket.

Can-Am Emblem Pullover Hoodie

288244 • XS*, S, M, L, XL, 2XL

Army Green (77), Black (90)



- Women's Signature pullover hoodie with Can-Am logo and emblematic lines at front.
- 60% cotton, 40% polyester.
 - Fit: Slim.
 - Rib at cuffs and hem.
 - Kangaroo pocket.

*XS only available in Black (90).

NEW Can-Am 1973 Signature Cap**288112** · One size

Army Green (77), Black (90), Grey (09), Red (30), Wine (32)



Signature curved cap.

- 100% cotton.
- 6-panel cap.
- Embroidery Can-Am patch at front.
- Snapback closure at back with small Can-Am label.

Can-Am Reversible Camo Beanie**288160** · One size

Army Green (77), Black (90), Grey (09)



Two-in-one reversible beanie with our new hexagon camo knit pattern.

- 95% acrylic, 4% nylon, 1% spandex.
- Hypoallergenic.
- Small folded Can-Am label at front.
- Embroidered Can-Am logo at front.

NEW 1973 Signature Bandana**288281** · One size

Black (90), Wine (32)



Our bandana is a cheerful accessory, perfect for our bold riders! It will become your new staple piece when riding.

- 100% cotton.
- Dimensions: 24" x 24".
- Can be worn many different ways.
- Checkered print, Can-Am logo and 1973 printed.

UV PROTECTION AND PLAY

Introducing our UV Protection and Play collection.

Your ultimate gear for all-day comfort, designed to protect against the sun. Featuring windproof jerseys, lightweight long-sleeve shirts, comfortable hoodies and more! All with new colors and graphics!



Men's UV Protection
Long-Sleeve T-Shirt
BLACK

288161_90

Women's
Can-Am
Lightweight
Tank Top

WINE

288167_32

Women's UV
Protection
Long-Sleeve T-Shirt
BLACK

288169_90

Men's UV Protection
Long-Sleeve Hoodie
ARMY GREEN

288168_77

UV PROTECTION AND PLAY

MEN'S

UV Protection Long-Sleeve T-Shirt

288161 • S, M, L, XL, 2XL

Black (90), Charcoal Grey (07)



Men's lightweight UV protection long-sleeve shirt, meant to protect your skin all day long.

- 92% polyester, 8% spandex.
- Fit: Regular.
- UPF 50 sun protection.

- Quick-dry fabric that helps distribute your body heat and rapidly cools through regulated evaporation.
- Can-Am artwork at back and Can-Am logo at right sleeve.

UV Protection Long-Sleeve Hoodie

288168 • S, M, L, XL, 2XL

Army Green (77), Black (90)



Men's UV protection long-sleeve hooded shirt with built-in gaiter to protect you from the dust and sun.

- 92% polyester, 8% spandex.
- Fit: Regular.
- 175 gsm.

- UV protection – 50 UPF.
- Quick-dry.
- Built-in gaiter mask.
- Can-Am logo on the right sleeve and artwork at left chest.

Can-Am DWR Hoodie

288158 • S, M, L, XL, 2XL, 3XL

Army Green (77), Black with Graphics (94)



Versatile pullover hoodie with water-repellent finish that will allow you to wear it no matter the weather!

- 60% cotton, 40% polyester.
- Fit: Regular.
- Rib at cuffs and hem.

- Kangaroo pocket.
- New! Hexagon camo print.
- Can-Am label at front kangaroo pocket.

Can-Am Lightweight Tank Top

288167 • XS, S, M, L, XL, 2XL

Charcoal Grey (07), Wine (32)



Women's lightweight tank top, perfect for everyday wear.

- 88% nylon and 12% spandex.
- Fit: Regular.
- UPF 20 sun protection.

- Quick-dry fabric that helps distribute your body heat and rapidly cools through regulated evaporation.
- Large vertical Can-Am logo on the left side.

WOMEN'S

UV Protection Long-Sleeve T-Shirt

288169 • XS, S, M, L, XL, 2XL

Black (90)



Women's lightweight UV protection long-sleeve shirt, meant to protect your skin all day long.

- 92% polyester, 8% spandex.
- Fit: Slim.
- UPF 50 sun protection.

- Quick-dry fabric that helps distribute your body heat and rapidly cools through regulated evaporation.
- Thumbhole opening at sleeve.
- Can-Am artwork at back.

UNISEX

Can-Am Phantom Jersey

288270 • S, M, L, XL, 2XL, 3XL

Army Green (77), Burgundy (35), Charcoal Grey (07), Grey (09)



Our classic Can-Am jersey with a new look!

- 100% polyester.
- Fit: Relaxed.
- Quick-dry, moisture-wicking fabric for maximum comfort.
- Antibacterial treatment for anti-odor.

- Mesh fabric for extra ventilation at underarms.
- Hexagon camo print.
- Sublimated logos.

TOYS AND COLLECTIBLES

MISC

NEW 1:12 Maverick X3 X RS Turbo RR Premium Replica	B10787 • One size	Black (90)	
---	--------------------------	------------	--



- Product dimensions: 286 x 155 x 145 mm.
- Diecast metal and plastic.
- Free-rolling wheels.
- Articulated steering.
- Functional suspensions.
- Openable doors.
- Interior cab details.
- Authentic exterior design.

NEW 1:12 X3 X RS Turbo RR Premium Replica with accessories	B10788 • One size	Red (30)	
---	--------------------------	----------	--



- Product dimensions: 281 x 155 x 161 mm.
- Diecast metal and plastic.
- Free-rolling wheels.
- Articulated steering.
- Functional suspensions.
- Openable doors.
- Interior cab details.
- Authentic exterior design.

NEW 1:12 Maverick X3 X RC Turbo RR Premium Replica	B10789 • One size	Red (30)	
---	--------------------------	----------	--



- Product dimensions: 286 x 155 x 145 mm.
- Diecast metal and plastic.
- Free-rolling wheels.
- Articulated steering.
- Functional suspensions.
- Openable doors.
- Interior cab details.
- Authentic exterior design.

NEW 1:32 Diecast Maverick Sport 24 pcs Case-Pack	B10790 • One size	Mixed color (18)	
---	--------------------------	------------------	--



- This Case-Pack includes:
- 12 x 1:32 Maverick Sport X rc (Red)
 - 12 x 1:32 Maverick Sport X xc (Silver)

NEW 1:32 Diecast Maverick Trail 24 pcs Case-Pack	B10791 • One size	Mixed color (18)	
---	--------------------------	------------------	--



- This Case-Pack includes:
- 12 x 1:32 Maverick Trail DPS (Black)
 - 12 x 1:32 Maverick Trail DPS (Blue)

NEW 1:32 Diecast Commander 24 pcs Case-Pack	B10792 • One size	Mixed color (18)	
--	--------------------------	------------------	--



- This Case-Pack Includes:
- 12 x 1:32 Commander XT-P (Orange)
 - 12 x 1:32 Commander XT (Black)

NEW Diecast Defender 24 pcs Case-Pack**B10793** · One size

Mixed color (18)



This Case-Pack includes:

- 12 x 1:32 Defender XMR (Silver)
- 12 x 1:32 defender XT HD9 (Navy)

1:32 Diecast Maverick Bundle**B10777** · One size

Mixed color (18)



Bundle includes:

- 10 x 1:32 Maverick X3 X RS Turbo RR (Black)
- 5 x 1:32 Maverick X3 X RS Turbo RR (Blue)
- 5 x 1:32 Maverick X3 X RS Turbo RR (Red)
- 2 x 1:32 Maverick X3 X RS Turbo RR Sand (Red)
- 2 x 1:32 Maverick X3 X RS Turbo RR Winter (Red)

1:32 Diecast Outlander Bundle**B10778** · One size

Mixed color (18)



Bundle includes:

- 12 x 1:32 Outlander XT 1000R (Blue)
- 12 x 1:32 Outlander XT 1000R (Yellow)

1:32 Diecast Renegade Bundle**B10779** · One size

Mixed color (18)



Bundle includes:

- 6 x 1:32 Renegade X xc (Sand)
- 6 x 1:32 Renegade X xc (Red)
- 6 x 1:32 Renegade X mr 1000R (Sand)
- 6 x 1:32 Renegade X mr 1000R (Gold)

REPLACEMENT PARTS

Helmet Service Pad**448695** · One size

Black (90)

- Part made to support a helmet while servicing it.

VIBE

Vibe Microphone**929132** · One size

Black (90)



- Fits Vibe Communication System by BRP.

Vibe Speakers**929133** · One size



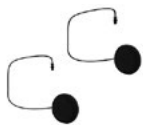



Black (90)



- Fits Vibe Communication System by BRP.

PYRA

MISC

<p>Pyra Headliner</p> 	<p>929060 • XS, S, M, L, XL, 2XL, 3XL</p>	<p>Charcoal Grey (07)</p>	
<p>• Fits Pyra helmet family.</p>			
<p>Pyra Cheek Pads</p> 	<p>929061 • XS, S, M, L, XL, 2XL, 3XL</p>	<p>Charcoal Grey (07)</p>	
<p>• Fits Pyra helmet family.</p>			
<p>Pyra Wind Deflector</p> 	<p>929062 • S (fits XS/S/M/L), L (fits XL/2XL/3XL)</p>	<p>Black (90)</p>	
<p>• Fits Pyra helmet family.</p>			
<p>Pyra Peak Pivots</p> 	<p>929073 • One size</p>	<p>Black (90)</p>	
<p>• Fits Pyra helmet family. • Includes 2 pcs.</p>			
<p>Pyra Fixed Peak Pivots</p> 	<p>929096 • One size</p>	<p>Black (90)</p>	
<p>• Fits Pyra helmet family. • Includes 2 pcs.</p>			
<p>Pyra Front Vent Grid</p> 	<p>929097 • S (fits XS/S/M/L), L (fits XL/2XL/3XL)</p>	<p>Black (90)</p>	
<p>• Fits Pyra helmet family.</p>			
<p>Can-Am Pyra Phantom Peak</p> 	<p>929163 • S (fits XS/S/M/L), L (fits XL/2XL/3XL)</p>	<p>Black (90), Grey (09)</p>	
<p>• Fits Pyra helmet style 929159.</p>			
<p>Pyra Fade Peak</p> 	<p>929091 • S (fits XS/S/M/L), L (fits XL/2XL/3XL)</p>	<p>Beige (02), Grey (09), Turquoise (Aqua) (76), White (01)</p>	
<p>• Fits Pyra helmet family.</p>			

Can-Am Pyra Peak**929063** · S (fits XS/S/M/L),
L (fits XL/2XL/3XL)Blue (80), Charcoal Grey (07),
Red (30)

- Fits Pyra helmet family.

Can-Am Pyra Dune Peak**929064** · S (fits XS/S/M/L),
L (fits XL/2XL/3XL)Charcoal Grey (07), Grey (09),
Red (30), Sand (03)

- Fits Pyra helmet family.

EXOME**NEW Exome Headliner**

DOT ECE22.06

929188 · XS, S, M, L, XL, 2XL,
3XL

Black (90)



- Fits Can-Am Exome Modular Helmet (DOT/ECE) (929190) and Can-Am Exome Open Face helmet (DOT/ECE) (929185).

Exome Single Lens Shield**929044** · One size

Clear (00)



- Fits Can-Am Exome Helmet (929040).
- Replacement Pinlock-ready face shield for Exome helmets.

Exome Summer Chin Curtain**929046** · One size

Black (90)



- Fits Can-Am Exome Helmet (929040).

Exome Peak Fasteners Kit**929047** · One size

Black (90)











- Fits Exome helmet family.

Exome Summer Headliner**929049** · XS, S, M, L, XL, 2XL, 3XL

Charcoal Grey (07)



- Fits summer Exome helmet family.

Exome Peak	929057 • One size	Black (90), Matte Black (93)	
	• Fits Exome helmet family.		
Exome Summer Vents Kit	929065 • One size	Black (90)	
	• Fits Exome helmet family.		
Exome Pinlock® Insert	929066 • One size	Clear (00)	
	• Fits Exome helmet family.		
Exome Shield Mechanism	929067 • One size	Black (90)	
	• Fits Exome helmet family.		
Exome Shield Sealing Gasket	929070 • One size	Black (90)	
	• Fits Exome helmet family.		
Exome Summer Sun Shield	 929072 • One size	Smoke (57), Clear (00)	
	• Fits Exome helmet family.		
Exome Summer Chin Lock Covers	929075 • One size	Black (90)	
	• Fits Exome helmet family.		
Exome Summer Cheek Pads	929092 • XS, S, M, L, XL, 2XL, 3XL	Charcoal Grey (07)	
	• Fits summer Exome helmet family.		

MISC

Exome Open Face Peak**929145** - One size

Black (90)

- Fits Exome Open-Face helmet family.

**Exome Open Face Headliner**

DOT

929147 - XS, S, M, L, XL, 2XL, 3XL

Charcoal Grey (07)

- Fits Exome Open-Face helmet family.
- DOT certified version only.

**Exome Open Face Cheek Pads****929148** - XS, S, M, L, XL, 2XL, 3XL

Black (90), Charcoal Grey (07)

- Fits summer Exome Open-Face helmet family.

**RETRO OPEN FACE**

MISC

NEW Retro Open Face RPM Peak**929192** - One size

Black (90)

- Fits Retro Open Face helmets.

**NEW Retro Open Face Cheek Pads****929193** - S, M, L, XL, 2XL

Black (90)

- Fits Retro Open Face helmet.

**FLINT**

MISC

Flint Goggles Tear-Offs**448759** - One size

Clear (00)

- Ready-to-use clear tear-off tabs.
- Pack of 10.

**Flint Goggles Nose Guard****448760** - One size

Black (90)

- Fits all Flint goggles:
 - Flint Dune
 - Flint Fade
 - Flint Phantom



MISC

Flint Goggles Clear Single UV Lens**448764** • One size

Clear (00)



- Fits all Flint goggles:
 - Flint Dune
 - Flint Fade
 - Flint Phantom

Flint Goggles Chrome Single UV Lens**448765** • One sizeBlue (80), Chrome (99), Red (30),
Turquoise (Aqua) (76), Yellow (10)

- Fits all Flint goggles:
 - Flint Dune
 - Flint Fade
 - Flint Phantom

Flint Photochromatic RPM Single UV Lens**448784** • One size

Smoke (57)



- Fits Flint goggle family.

TRENCH

MISC

Trench Goggles Nose Guard**448708** • One size

Black (90)



- Fits Trench goggles.

Trench Goggles Single UV Lens**448697** • One size

Clear (00)



- Trench anti-scratch, anti-fog RPM lens.
- Clear.

Trench OTG Goggles Single UV Lens**448793** • One size

Clear (00), Smoke 60% (21)



- Fits Trench OTG goggle family.
- Can-Am laser etching on lens.

Trench Goggles Tear-Offs**448727** • One size

Clear (00)



- Compatible with the Can-Am Trench goggle.
- Pack of 10.

Trench OTG Goggles Tear-Offs**448795** • One size

Clear (00)



- Fits Trench OTG goggle family.
- Pack of 10.



A man in a black and red long-sleeved shirt with a white and black striped pattern on the front, grey cargo pants, and tan work boots stands leaning against the side of a dark-colored ATV. He is smiling and looking towards the other man.

A man in a maroon long-sleeved shirt, light blue jeans, and green rubber boots sits on the seat of the ATV. He is also smiling and looking towards the first man. He is wearing black riding gloves.

The ATV is a dark-colored utility vehicle with large, knobby tires. It has a roll-over protection structure (ROPS) and a front windshield. The vehicle is parked on a ground covered in pine needles. The background consists of tall, thin trees in a forest.



OUTLANDER

yan-am
RACING

FALCON RACING

YAMAHA



BRP REIMAGINES THE WAY YOU ACCESS YOUR WORLD

Can-Am is one of many success stories from BRP, the global company behind some of the most daringly innovative products and experiences that move you. Because it's not about the destination, it's about the journey — yours.

Discover our brands:

ski-doo **LYNX** **SEA-DOO** **can-am** **ROTAX**

www.brp.com





CANAMOFFROAD.COM

MY26 716001969

