





*Enjoying the Journey.....*



**SERVICE, PARTS & WARRANTY BUILDING**



**PLANT TWO**



**MAIN HEADQUARTERS- PLANT ONE**

# *On a Mission*

At Open Range RV, we are on a mission to...

Fulfill the trailer needs of our dealer base and retail customers, and in doing so, exceed their expectations for service, quality and value.

Earn our dealers', retail customers' and employees' long-term loyalty by delivering more than we promise, in a fair and honest business manner.

Motivate our employees to provide exceptional service and quality to our retail customers and dealers.

Compensate our employees fairly and provide opportunity for personal growth within our company.

Although it is our goal to provide a product that exceeds our customer needs and level of quality, we do not strive to be the biggest or the most profitable. In the end, we believe satisfied customers, dealers and employees will bring growth and long term profitability for all.

For almost 30 years, I have had the great fortune to work in the amazing industry of RV manufacturing. This industry runs through my blood and is the passion of my life. This has been a dream come true for me and my family. I would like to thank everyone who believed in us as an RV Manufacturer. At Open Range our motto is ENJOY THE JOURNEY!

It has been an amazing JOURNEY so far! Come join us on this great JOURNEY, we don't want you to miss another moment of it.

Enjoy the Journey!

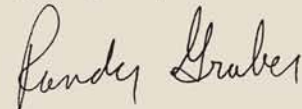

Randy Graber, President  
Open Range RV Company





Model 386FLR Kitchen in Pinto Decor

### DUAL LEAF DINETTE TABLE



- Hardwood Table Top with Dual Leaf to Sit up to 6 People!
- Includes Dinette Ladder Chair
- Promotes Family Style Dining for Everyone!



### FULL EXTENSION STAINLESS STEEL BALL BEARING DRAWER GUIDES



### CORIAN COUNTERTOPS

WITH FLUSH MOUNTED SINK COVERS



- Durable Finish for Years of Use
- Nonporous Surface - Easy to Clean
- Easy Repair if Damaged
- Stainless Steel Sink
- Single Lever Pullout Spray Faucet



PULL OUT TRASH CAN





Model 386FLR Living Room in Pinto Decor



386FLR TV in Up Position

**"COMFORT CLOUD" FIRM  
FOAM PILLOW TOP MATTRESS**



***RADIUS BED BASE WITH  
TONS OF STORAGE***

- Easy Lift Strut Assist
- Radius Base for Easy "Walk Around"
- Full Depth Base to Fit all Your Items







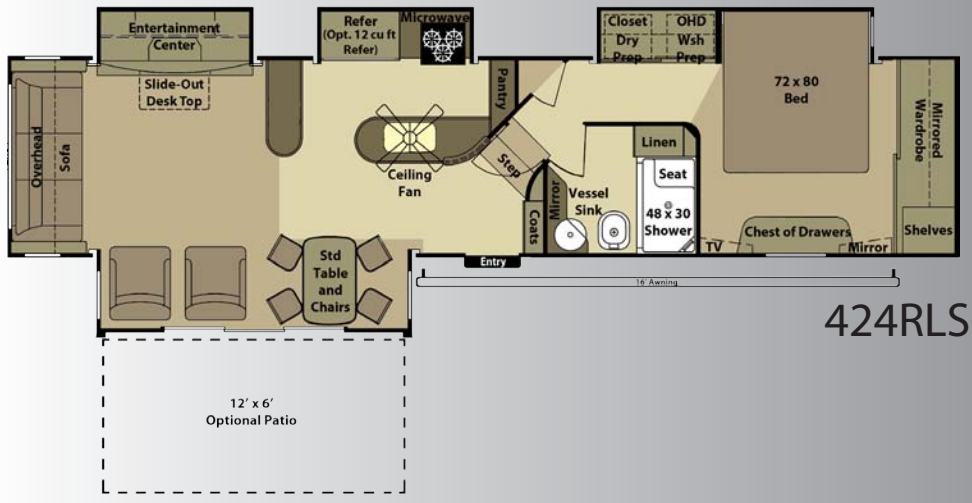

424RLS

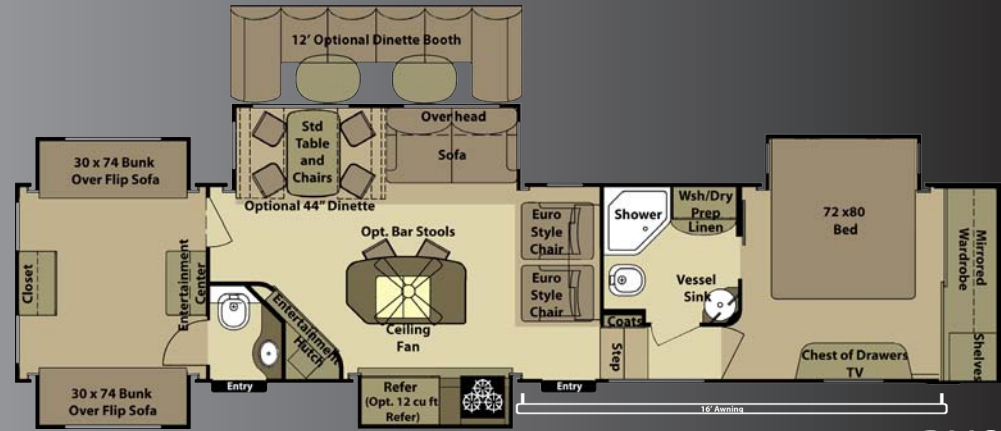

427BHS

	GVWR	UVW	Hitch Wt.	Axle Wt.	Gross NCC	Ext. Length	Ext. Height	Ext. Width	Water Heater Gas/Elec	Fresh Water	Gray Water	Waste	LP Gas (Lbs)	Furnace (BTU's)	Tire Size	Awning Size
345RLS	12560	8960	2160	6800	3600	34'6"	155"	100"	10 Gal	85	57	41	80	35,000	16"	16'
386FLR	16515	11205	2515	8690	5310	40'	155"	100"	10 Gal	85	57	41	80	40,000	16"	15'
391RES	13920	10380	1920	8460	3540	37'6"	155"	100"	10 Gal	85	57	41	80	40,000	16"	16'
399BHS	13990	10995	1990	9005	2995	38'6"	155"	100"	10 Gal	85	82	82	80	40,000	16"	16'
413RLL	16165	11970	2165	9805	4195	39'9"	155"	100"	10 Gal	85	82	82	80	40,000	16"	19'
424RLS	16280	11695	2280	9415	4585	40'	155"	100"	10 Gal	85	82	41	80	40,000	16"	16'
427BHS	15600	11840	1920	9920	3760	41'9"	155"	100"	10 Gal	85	82	82	80	40,000	16"	16'



# Residential



Model R412RSS Kitchen in Sedonna Decor

## EXTRA LARGE RESIDENTIAL PANTRY WITH SWINGING SHELVES



### SOLID CORE 6-PANEL DOOR TO WASHROOM



- Elegant Knotty Alder Bath & Bedroom Doors
- High End Look & Feel
- Durable Quality
- Easy to Open & Close

### SOLID CORE FRENCH DOOR TO BEDROOM



### 23 CUBIC FOOT REFRIGERATOR

- Frigidaire Residential Style Refrigerator
- Tons of Storage Space!
- Ice Maker and Water Dispenser
- Designated Battery Plumbed to Refrigerator
- Built in 600w Inverter







**EXTRA DEEP CHEST OF DRAWERS**



- 100 lb. Ball Bearing Drawers Guides
- Full Extension for Easy Access
- Drawer Bottom Support Brace for Quality that Lasts

**TRIPLE SLIDING MULLION WARDROBE DOORS**



Model R412RSS Bedroom in Sedonna Decor

**ONE PIECE FIBERGLASS SHOWER**

- No Seams or Cracks
- Easy to Clean
- Elegant Shower Seat
- Spacious Interior
- Thick Base for Maximum Strength



# Residential Floorplans

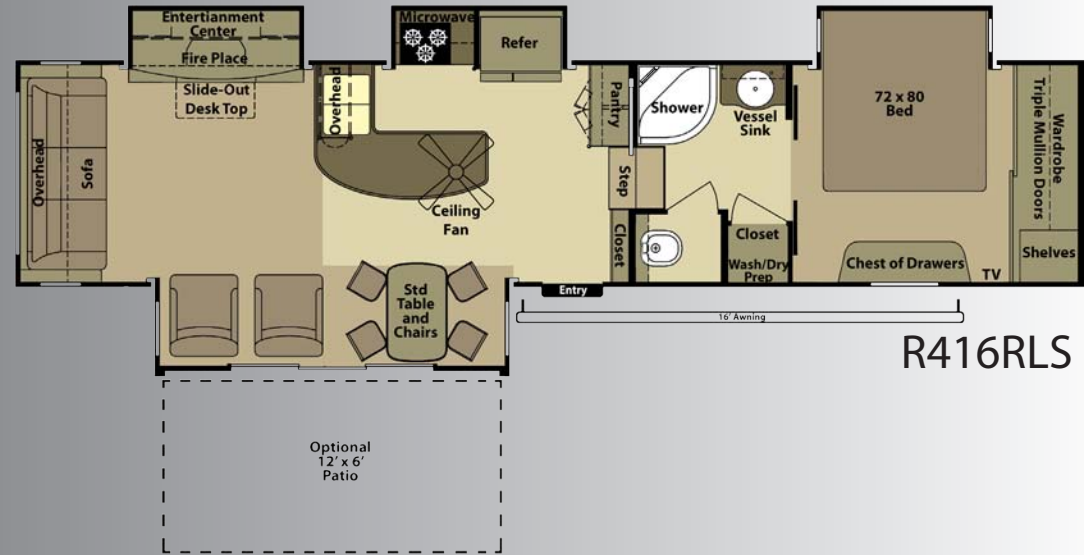
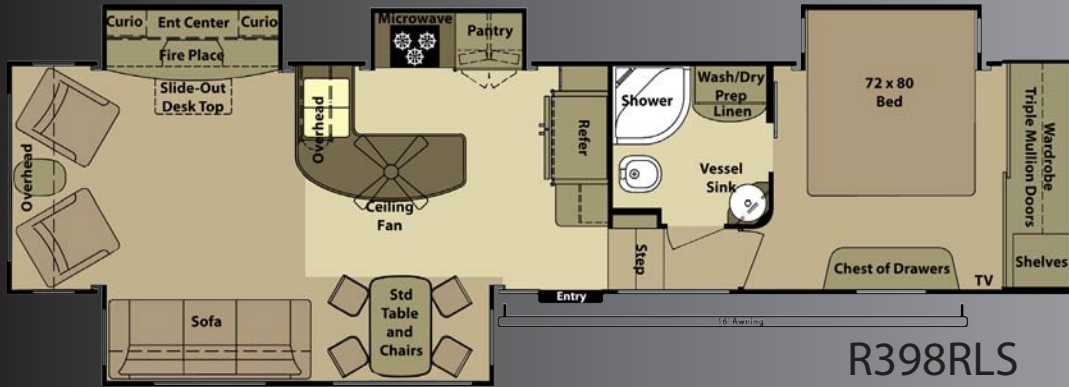

	GVWR	UVW	Hitch Wt.	Axle Wt.	Gross NCC	Ext. Length	Ext. Height	Ext. Width	Water Heater Gas/Elec	Fresh Water	Gray Water	Waste	LP Gas (Lbs)	Furnace (BTU's)	Tire Size	Awning Size
R398RLS	13960	10995	1960	9035	2965	39'	155"	100"	10 Gal	85	82	41	80	40,000	16"	16'
R416RLS	15000	11805	2555	9250	3195	40'	155"	100"	10 Gal	85	82	41	80	40,000	16"	16'



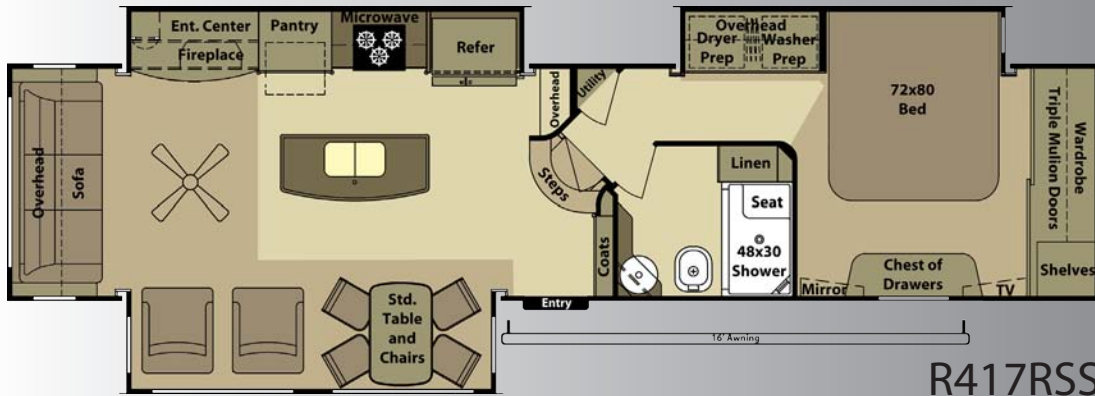

R417RSS

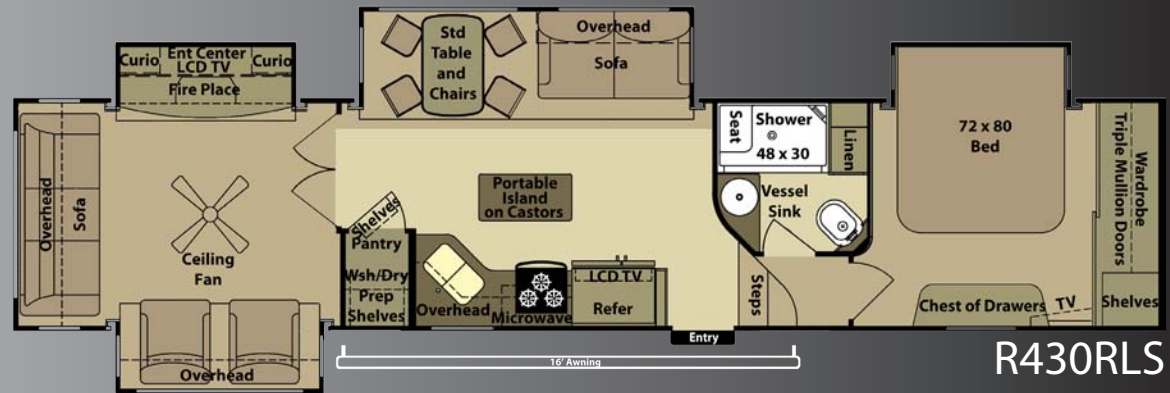

R430RLS

	GVWR	UVW	Hitch Wt.	Axle Wt.	Gross NCC	Ext. Length	Ext. Height	Ext. Width	Water Heater Gas/Elec	Fresh Water	Gray Water	Waste	LP Gas (Lbs)	Furnace (BTU's)	Tire Size	Awning Size
R417RSS	14520	11795	2520	9275	2725	39'3"	155"	100"	10 Gal	85	82	41	80	40,000	16"	16'
R430RLS	15600	12130	2530	9600	3470	42'	155"	100"	10 Gal	85	82	41	80	40,000	16"	16'

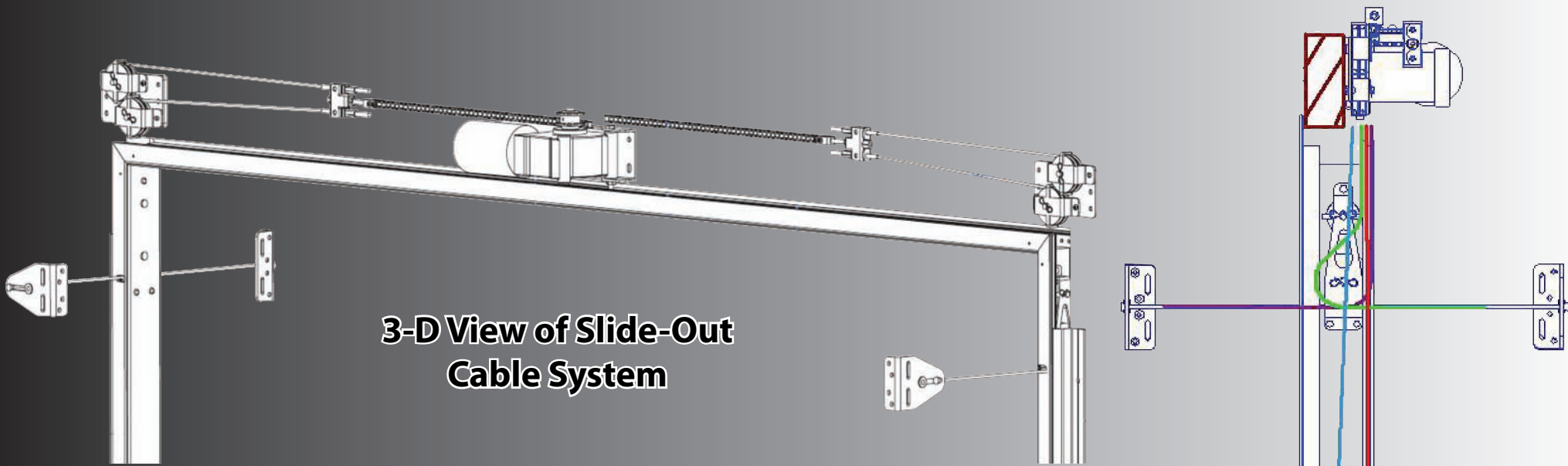

**3-D View of Slide-Out Cable System**

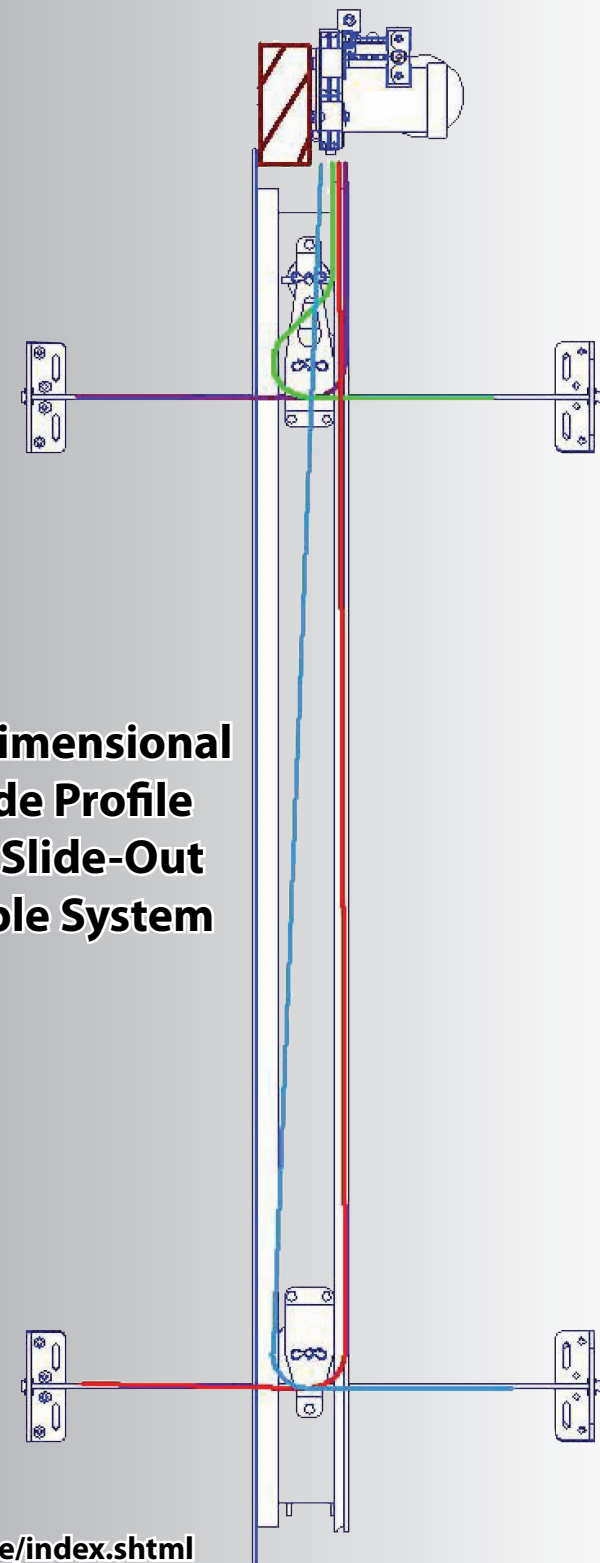

**1- Dimensional Side Profile Of Slide-Out Cable System**

## 10 Reasons Why... Accu-Slide

1. Above floor design means more storage area for your RV
2. Lightweight design promotes fuel savings
3. High strength stainless steel aircraft cable is used for control
4. Cable control at all 4 room corners helps stop leaks
5. Working components are in your RV, safe from the elements
6. Locking motor secures room in or out to help stop leaks
7. Above floor design minimizes maintenance requirements
8. A clean system - no leaky hydraulic lines or greasy drives
9. Smooth, quiet room movement - no jumping or jerking
10. It's built in the U.S.A. and backed by BAL since 1972



# Construction Cutaway

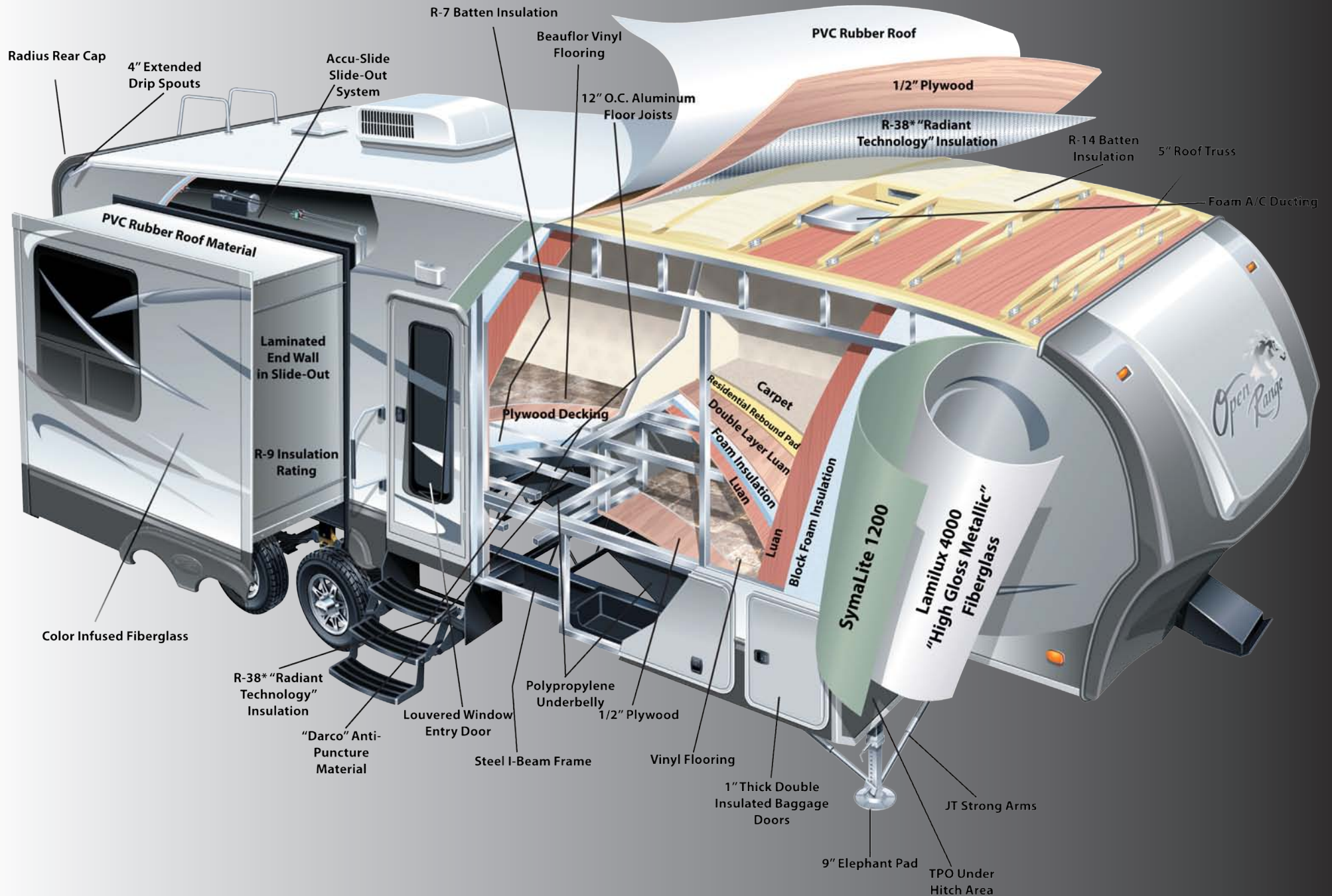

# Interior Construction

**100 LB. FULL EXTENSION  
DRAWER GUIDES**



**RUSSIAN BIRCH DOVETAILED  
DRAWER CONSTRUCTION**



**HARDWOOD CABINET CONSTRUCTION**



- Hardwood Cabinet Doors and Drawer Faces
- Lumber Core Stiles
- Mortis & Tenon Joints
- Residential Style Hidden Hinges

**7-LAYER BEAUFLOL VINYL FLOORING**

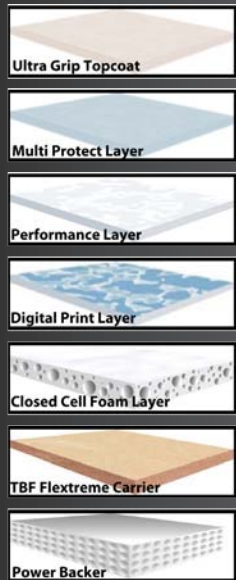

**CABINET CONSTRUCTION**



- Face Frames are Tube Drilled and Screwed for Maximum Strength

**HIDDEN HINGES**



- Elegant Euro-Style Spring Loaded Hardware
- Keeps Doors Closed Tightly
- Fully Adjustable to Customize Fit

**SOLID WOOD SLIDEOUT FASCIAS**





# Exterior Construction

## 1/2" PLYWOOD ROOF DECKING

- 1/2" Thick Plywood
- 350 lb. Rating
- Constructed with Real Plywood
- More Durable
- Better Quality



## PVC RUBBER ROOF MATERIAL

- Ultra Violet Resistant
- No Streaking or Chalking
- No Reconditioning Needed
- 30% Lighter Weight Than EPDM Rubber Roof
- Self Extinguishing
- Can be Recycled



## SYMALITE 1200 SIDEWALL SUBSTRATE

- Man-Made Composite Technology
- 125% More Puncture Proof
- Additional Insulator
- Noise Reduction
- Moisture, Mold, & Swell Resistant
- Provides the Best Possible Bond with Fiberglass

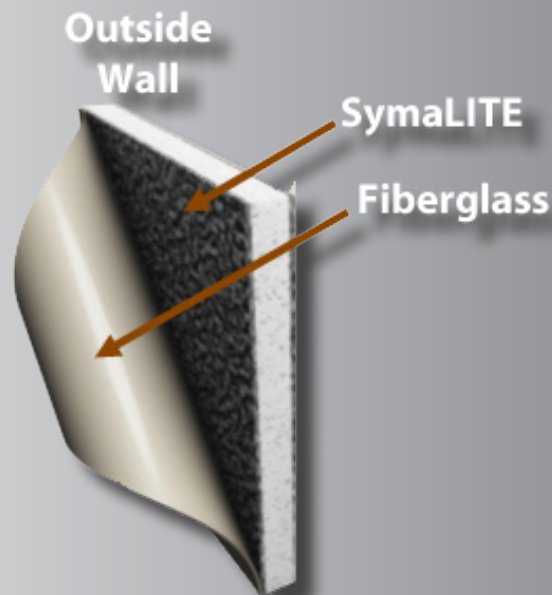

- At 30% Compression the PVC Foam Seal is 100% Waterproof
- Permanent Seal that Won't Deteriorate
- Provides a Complete and Consistent Seal Throughout

## PVC FOAM SEALS



# Exterior Features

15,000 BTU A/C  
w/ "Quick Cool" Feature

4" Extended  
Drip Spouts



Frameless Windows

3 Function  
Wireless Remote



**MAXAIR**  
VENT CORP

**Carefree**  
Power Awning

50 Amp  
Service with  
LED Power  
Indicator



Contoured Front Cap For  
Tighter Turning Radius

(Optional) Air Ride  
Pin Box

Dexter EZ-Flex Suspension



Extended Skirt Metal  
Frame Shield

Metal Slam Latch  
Baggage Doors



Slideout LP Trays  
(80 lbs Capacity)

JT Strong Arm Stabilizers



Leveling System  
Control Panel



Outside Convenience  
Center

  
**DEXTER AXLE**



# Four Seasons Protection Package



- Atwood High Performance Furnace
- Heated Storage Area
- Insulated Slide Floors
- Vented Attic
- Double Insulated Baggage Doors
- Digital Thermostat
- Heated Underbelly
- Heated and Enclosed Dump Valves
- R-38 Roof Insulation\*
- R-38 Floor Insulation\* (above tanks)
- R-38 Below Holding Tanks\*
- R-9 Sidewalls

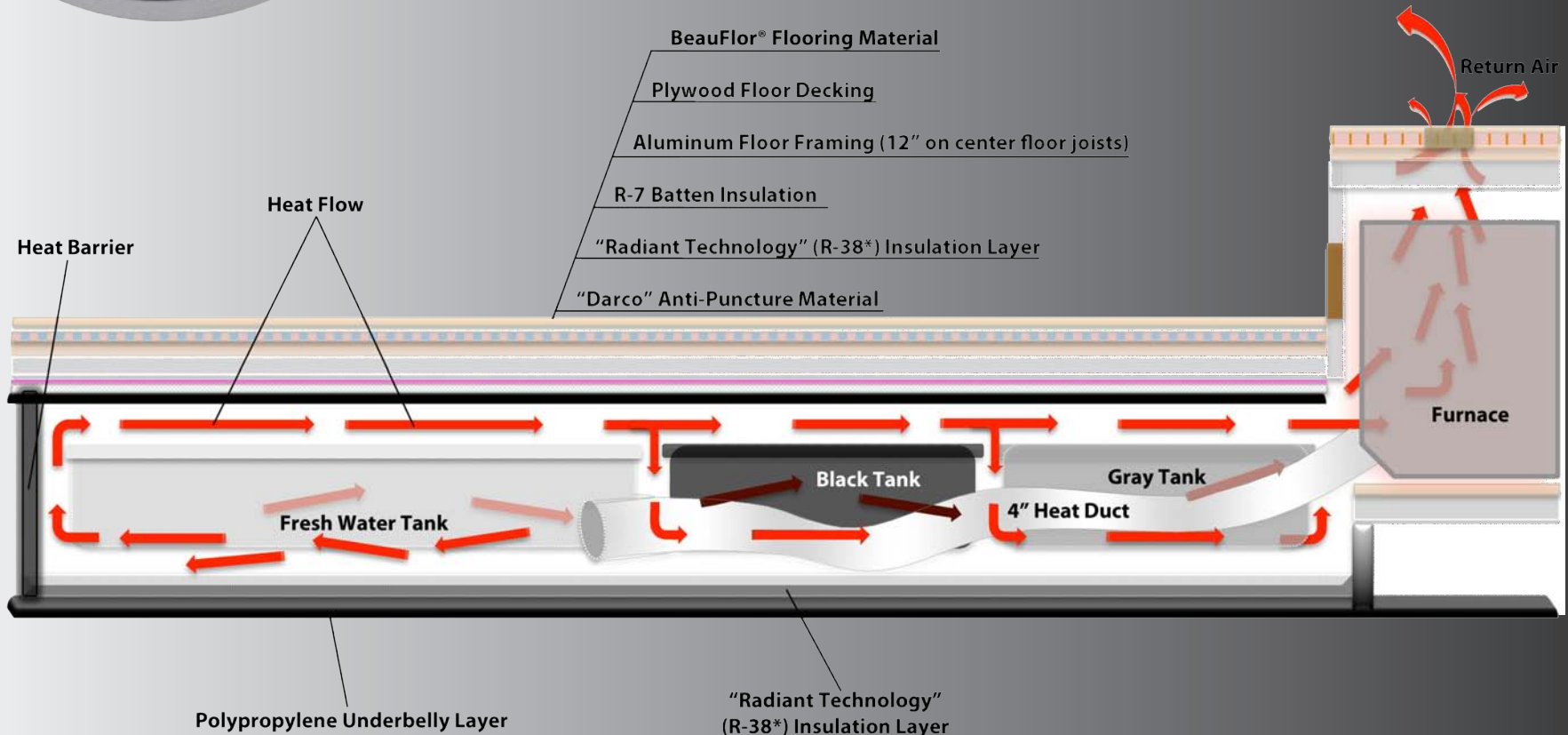

# Executive Package

## Interior:

- Flat Screen TV in Living Area
- LED Bedroom TV w/ Portable Swingarm Brackets
- 12V CD/DVD/MP3/AM/FM/iPod® Stereo
- Corian® Countertops
- Fantastic Fan in Kitchen
- "Comfort Cloud" Pillowtop Mattress
- Dinette Step-Chair
- Knotty Alder Raised Panel Cabinet Doors
- Solid Wood Slide-Out Fascia
- Concealed Hinges
- Dovetail Drawer Construction
- Dual Leaf Extension Dinette Table
- Wood Framed Sliding Wardrobe Doors (*Residential Only*)
- Residential Pantry w/ Swinging Shelves (*Residential Only*)

## Interior cont...

- Residential 23 cu ft Refer (*Residential Only*)
- Residential Style 22" Glass Front Oven (*Residential Only*)
- One Piece Fiberglass Shower (*Residential Only*)
- Solid Wood Doors to Bed & Bath (*Residential Only*)

## Exterior:

- 15,000 BTU A/C w/ "Quick Cool" Feature
- Multi-Port Satellite Connection
- Digital TV Antenna w/ Booster
- 10 Gal Gas/Elec Quick Recovery Water Heater
- Carefree of Colorado Power Awning
- One-Touch Automatic Leveling System
- JT Strong Arm Stabilizer Bars
- Metal Slam Latch Baggage Doors
- Frameless Windows
- Multi-Function Remote for Slide Room, Awning, & Patio



## Equipped with JACK® DIGITAL HDTV ANTENNA

with Integrated SureLock  
TV Signal Meter!

- \* No need to crank up or down and is always ready for travel
- \* Built-in signal meter for fast and accurate antenna pointing
- \* Full 360° rotation allows for precise antenna pointing with no "dead spot"

A PRODUCT OF  
**KING  
CONTROLS**





# Decors

Sofa Solid

## Lifelong

Sofa Print  
 Dinette Chair  
 Booth Dinette Back  
 U-Lounge Back

Recliner  
 Booth Dinette Seat  
 U-Lounge Seat



Sofa Solid

## Sedonna

Sofa Print  
 U-Lounge Back

Dinette Chair  
 U-Booth Back

Recliner  
 Booth Dinette Seat  
 U-Lounge Seat



Sofa Solid

## Pinto

Sofa Print  
 U-Lounge Back

Dinette Chair  
 U-Booth Back

Recliner  
 Booth Dinette Seat  
 U-Lounge Seat



## Interior Standards

- Stainless Steel 50/50 Sink w/ Single Lever Spray Faucet
- Heavy Duty Full Extension Drawer Guides
- Pull-Out Wastebasket
- Ceiling Fan
- Crown Molding
- Washer/Dryer Prep
- Porcelain Toilet w/ Foot Pedal Flush
- Wired and Framed for 2nd A/C in Bedroom
- LED Lighting in Ceiling

**TWO-YEAR LIMITED  
TRANSFERABLE WARRANTY**

## Exterior Standards

- 100" Wide Body Frame w/ Wide Stance Axles
- Dexter E-Z Lube Axles
- EZ Flex Suspension
- Extra Large 4" Gutter Spouts
- 16" Aluminum Wheels
- Rear Fiberglass Cap
- Removable Rear Ladder
- Dual LP Slide Trays (80lb capacity)
- Full View Vented Entrance Door
- Nitrogen Filled Radial Tires
- PVC Rubber Roof
- 50 Amp Service



# OPEN RANGE

Open Range RV Company 3195 N. St. Rd. 5 Shipshewana, IN 46565

Phone: (260) 768-7771 - [www.OpenRangeRV.com](http://www.OpenRangeRV.com)

Due to continual research and advances, manufacturer reserves the right to change specifications, design, price, and equipment without notice, and assumes no responsibility for any error in the literature. Some items shown are not included as standard or optional equipment

©2012 Open Range RV Company, Shipshewana, Indiana

Published Date: June 25<sup>th</sup>, 2012

## **PURCHASE LOCALLY**

Open Range RV strongly encourages our retail customers to purchase from their local dealership whenever possible due to the following reasons:

1) Our Dealers are, as a rule, independently owned and operated businesses. Outside of those customers they personally sold products to, they are not obligated to perform warranty service on Open Range RV products that were purchased elsewhere. There may be an occasion that the customer will be required to return to the point of purchase to satisfy warranty requirements.

2) Although many dealerships will eventually service products not purchased at their dealership, they will usually take care of their customers and other Open Range RV customers who are traveling away from their local dealer as a priority.

3) Local purchases allow a customer to establish a relationship with a dealer close to home. This relationship provides the customer with a convenient location for service and support from a "local" professional.

4) The opportunity for a thorough PDI (Pre Delivery Inspection) and product orientation is an additional benefit of buying from a local dealer. The opportunity for refresher courses or the ability to get questions answered more promptly is another additional benefit of buying from a local dealer.

5) For our Canadian customers, there are also requirements which must be met to bring an RV purchased out of the country to their home. Although not impossible, these requirements may involve such things as additional inspections, certifications, taxes and fees. The local Canadian Dealer is a professional at meeting these requirements.

6) Open Range's goal is for all RV Owners to fully enjoy their RV experience. In light of this goal, and considering the advantages of buying locally, we encourage you to be thorough when determining what product to purchase and which dealer to purchase it from as both are key to your ultimate satisfaction.

**Your Open Range Dealer:**